



PARENT STOCK

Management Handbook

2023



This Handbook

Use this button to visit
the contents pages

The purpose of this Handbook is to help Aviagen® customers optimize performance from their parent stock. It is not intended to provide definitive information on every aspect of parent stock management, but to draw attention to important issues, which if overlooked or inadequately addressed, may depress flock performance. The management techniques contained within this Handbook have the objectives of achieving good flock health and welfare, and obtaining excellent flock performance.

Introduction

Aviagen produces a range of genotypes suitable for different sectors of the broiler market. All Aviagen products are selected for a balanced range of parent stock and broiler characteristics. This variety allows our customers to choose the product that best meets the needs of their particular operation.

As parent stock, all Ross® genotypes are selected to produce the maximum number of vigorous day-old chicks by combining high egg numbers with good fertility, hatchability and welfare. This combination is achieved by mating male lines that are bred in a balanced way with emphasis on optimal growth, feed efficiency and high meat yield, with females that are selected for the same health, welfare and broiler characteristics, and output of high numbers of eggs.

This Handbook summarizes best-practice parent stock management for all Ross parent stock, taking into account the ongoing selection for improved broiler traits. Additional management advice for specific Ross products can be found on the Aviagen website.

Performance

The most common management strategy worldwide is for birds to receive first light stimulation after 21 weeks (147 days) of age and achieve 5% production at 25 weeks of age, as this gives distinct advantages in early egg size, chick numbers and broiler chick quality. However, poultry production is a global activity and, across the world, differing management strategies may need to be adapted for local conditions.

The information presented is a combination of data derived from internal research trials, published scientific knowledge, and the expertise, practical skills and experience of the Aviagen Technical Transfer, Technical Service and Global Technical Operations teams. However, the guidance within this Handbook cannot wholly protect against performance variations that may occur for a wide variety of reasons. Aviagen therefore accepts no ultimate liability for the consequences of using this information to manage parent stock.

Use the forward
arrow to move to
the next page



Customer Services

For further information, please contact your local Ross representative or visit the website at www.aviagen.com.

Buttons will link to
external sources
throughout

Use the back
arrow to return to
the previous page

Using this Handbook

Finding a Topic

The Table of Contents gives the title and page number of each section and subsection. In the interactive Handbook, the sections and subsections are hyperlinked for easy access.

The interactive Handbook features the ability to find information quickly with hyperlinked references to similar topics that are discussed across multiple sections.

Appendices and an alphabetical Keyword Index are provided at the end of the Handbook.

Key Points and Useful Information



Look for this symbol to find **Key Points** that emphasize important aspects of husbandry and critical procedures.



Look for this symbol to find suggestions for **Other Useful Information** on specific topics in this Handbook.

Look for this symbol for direct links to publications in the Info Center of the Aviagen website, unless otherwise stated.

Look for this symbol to view short management videos.

Supplements to this Handbook

Supplements to this handbook contain performance objectives that can be achieved with good management, as well as nutritional, environmental and health control. Nutrition specifications are also available. All management information can be found online at www.aviagen.com, by contacting your local Ross representative, or by emailing info@aviagen.com.

Contents

Choose any row to
jump to the page
in the document

Key Management Timetable **7**

Stockmanship **10**

SECTION 1: REARING (0-105 DAYS/0-15 WEEKS)

Management Requirements for Males and Females During Rear **15**

Chick Management 17

Equipment and Facilities 30

Best Practice in the Absence of Beak Treatment 36

Grading to Manage Uniformity **38**

General Procedures for Grading 39

Flock Management After Grading (Post 28 Days) 43

SECTION 2: MANAGEMENT INTO LAY (15 WEEKS TO PEAK PRODUCTION)

From 105 Days (15 Weeks) to Light Stimulation **49**

Management Considerations 49

Management of Females Post Light Stimulation Until 5% Production **59**

Management Considerations 59

Floor Eggs 60

Nest Box Set-up 61

Management of Females from 5% Hen-day Production Until Peak Egg Production **62**

Management Considerations 62

Feed Clean-up Trends 63

Egg Weight and Feed Control 63

Management of Males Post Light Stimulation Until Peak Egg Production **65**

Feeding Considerations 65

Mating Ratio 66

Over-mating 66

SECTION 3: MANAGEMENT IN LAY (PEAK TO DEPLETION)

Management of Females After Peak Production Through to Depletion **67**

Factors for Post-peak Management 67

Procedures 68

General Guidelines for Post-peak Feed Reductions Based on Target Performance Characteristics 68

Monitoring Post-peak Feed Reduction 71

Post-peak Feed Reductions and Environmental Temperature 72

Management of Males After Peak Production Through to Depletion **73**

Procedures 73

SECTIONS
4-7

Choose any row to
jump to the page
in the document

SECTION 4: MONITORING BROILER BREEDER GROWTH

Monitoring Broiler Breeder Growth	75
Body-weight Weighing Methods	75
Methodology for Sample Weighing	77

SECTION 5: ASSESSMENT OF BIRD PHYSICAL CONDITION

Assessment of Bird Physical Condition	81
Assessing Bird Condition	81
Assessment of Male Condition	81
Assessment of Female Condition	90

SECTION 6: CARE OF HATCHING EGGS ON FARM

Care of Hatching Eggs	93
Why Do Hatching Eggs Need Care?	93
Egg Fertilization and Early Embryo Development	93
Bacterial Contamination- Barriers and Facilitators	94
Best Practice for the Care of Hatching Eggs	96

SECTION 7: ENVIRONMENTAL REQUIREMENTS

Housing	101
Farm Location and Design	101
House Design	103
Ventilation	105
Air	106
Housing and Ventilation Systems	106
Minimum Ventilation	109
Transitional Ventilation	114
Tunnel Ventilation	116
Evaporative Cooling Systems	118
Light Baffles/Traps	122
Lighting	123
Lighting During Brooding	123
Lighting Programs and Housing Type	123
Considerations for Lighting Management	130

SECTIONS
1-3

SECTIONS
8-9

Choose any row to
jump to the page
in the document

SECTION 8: NUTRITION

Nutrition	135
Broiler Breeder Nutrition	135
Supply of Nutrients	135
Feeding Programs and Diet Specifications	138
Feed Manufacturing	140
Water	142

SECTION 9: HEALTH AND BIOSECURITY

Health and Biosecurity	143
The Relationship Between Management, Disease Expression and Bird Welfare	144
Hygiene Management	144
Water Quality	150
Dead Bird Disposal	152
Health Management	152
Health Monitoring Programs	156

APPENDICES

Appendix 1 - Records	159
Appendix 2 - Useful Management Information	161
Appendix 3 - Conversion Tables	162
Appendix 4 - Grading Calculations	165
Appendix 5 - Calculations for Ventilation Rates	170

KEYWORD INDEX

Keyword Index	174
---------------	-----

Key Management Timetable

The critical age objectives for parent stock are summarized in the table below.

Age	Action
Before chick delivery	<p>All housing and equipment should be cleaned and disinfected, and effectiveness of biosecurity operations verified prior to chick placement.</p> <p>Preheat the house. Temperature and relative humidity (RH) should be stabilized for at least 24 hours prior to the chicks being delivered.</p> <p>House set-up should be completed prior to chick arrival. Litter should be evenly spread on the floor, that has been preheated to a temperature of 28-30°C (82-86°F). Litter temperature should also be 28-32°C (82-90°F). Drinkers and feeders must be in place and should be filled immediately prior to placement so chicks have immediate access to fresh feed and clean water. Drinking water should be at a temperature of 18-21°C (64-70°F).</p> <p>Ensure good biosecurity. Pathogens can survive in the surrounding environment even before the chicks have been placed. Biosecurity before chick delivery is equally, if not more, important than biosecurity after chick arrival.</p>
On chick arrival	<p>Achieve optimum environmental temperature, which is critical for stimulating both appetite and activity.</p> <p>Establish a minimum ventilation rate, which will ensure that fresh air is supplied to the chicks, help to maintain temperature and RH, and allow sufficient air exchange to prevent the accumulation of harmful gases.</p> <p>Combine vent temperature measurement with monitoring chick behavior to ensure that temperature is correct.</p> <p>Bulk weigh a sample of chicks.</p>
1 week	<p>Develop appetite from good brooding practices.</p> <p>Ensure adequate access to feed and water, provide good quality feed and maintain optimum temperatures.</p> <p>Provide 23 hours of light and 1 hour of dark for the first 2 days after placement.</p> <p>Light intensity must be uniformly distributed throughout the brooding area. A light intensity of 80-100 lux (7-9 fc) must be provided in the brooding area to promote feed and water intake.</p> <p>Use crop fill assessment as an indication of appetite development. Monitor bird behavior and adjust house environment as necessary.</p>
1-2 weeks	<p>Achieve target body weights.</p> <p>Obtain body-weight sample. Bulk weighing of birds is required at 7 and 14 days (1 and 2 weeks) of age. A minimum of 2% or 50 birds (whichever is larger) should be weighed from each population.</p> <p>Where possible, provide a constant (8 hour) daylength by 10 days of age. In open-sided houses, daylength will depend on the placement date and the natural daylength patterns.</p> <p>Increasing the number of birds weighed or the frequency of weighing (2-3 times a week) during the first 2-3 weeks after placement will be beneficial.</p> <p>If 14-day (2-week) body weights for previous flocks have regularly been below target, a longer daylength can be provided until 21 days (3 weeks) of age to help stimulate feed intake and improve body-weight gain.</p>

Age	Action
2-3 weeks	Start recording individual body weights between 14 and 21 days (2 and 3 weeks) of age. This information is required to calculate body-weight uniformity (Coefficient of variation [CV%]).
4 weeks	Grade males and females at 28 days (4 weeks). After grading, revise body-weight profiles to ensure that birds achieve target body weights by 63 days (9 weeks).
4-9 weeks	Ensure adequate feeder space and feed distribution are achieved. Monitor and record body weight weekly. If necessary, adjust daily feed allocation for the male and female populations to achieve any revised body-weight targets and maintain uniformity. The main focus during this period is to achieve good skeletal uniformity and correctly control the growth within each graded population.
9 weeks	Re-examine graded population weights in relation to the body-weight target. Combine populations that are of similar weight and feed intake. If populations are not following the target profile, a new target body-weight line should be drawn. For populations that are over the target weight, a new target line should be drawn so that the birds are managed towards target body weight by 105 days (15 weeks). Populations that are under the target should gradually be brought back to target by 105 days (15 weeks).
9-15 weeks	Ensure correct feeding space and feed distribution are achieved. Monitor and record body weight weekly. If necessary, adjust daily feed amounts for the male and female populations to achieve the target or any revised body-weight targets, and maintain uniformity. The main focus during this period is to control the growth within each graded population correctly.
15 weeks	Re-examine body weights in relation to target. Underweight birds need to be brought back to target by 147 days (21 weeks). For populations that are over the target weight, a new target line should be drawn parallel to the target. Remove any sexing errors as they are identified. Movement of birds between populations should stop.
15-23 weeks	Ensure correct feeding space and feed distribution are achieved. Achieve correct weekly body-weight gains by ensuring the appropriate feed amounts are given, particularly from 105 days (15 weeks) onwards. All populations should achieve similar body weight by light stimulation. Significant variation in body weight between populations at this age will lead to production problems in lay.
18-21 weeks	Remove remaining sexing errors. Begin assessment and recording of pin bone spacing, pin bone shape, fat deposit and fleshing.
20 weeks	Calculate and record the uniformity (CV%) and evaluate the sexual maturity of the flock to determine the lighting program. If the flock is even (CV less than or equal to 8%) and sexually mature, follow the normal recommended lighting program. If the flock is uneven (CV greater than 8%) and sexually immature for age, light stimulation should be delayed by 7-14 days (1-2 weeks).

Age	Action
21-23 weeks	<p>First light increase given (not before 147 days/21 weeks of age).</p> <p>Monitor and record body weight and uniformity weekly.</p> <p>Ensure 85-90% of females reach pin bone space around 2-2.5 fingers (3.8-4.2 cm / 1.5-1.7 in).</p>
21-24 weeks	<p>Mating-up: the exact time will depend on the relative maturity of both males and females.</p> <p>Immature males should never be mated with mature females.</p> <p>If males are more mature than females, they should be introduced gradually.</p> <p>Monitor and record body weight weekly.</p>
24-25 weeks	<p>Introduce the breeder feed ration from 5% hen-day production.</p>
23-28 weeks	<p>From first egg, increase feed amounts according to the rate of daily egg production, daily egg weight and body weight.</p> <p>Monitor and record body weight weekly.</p>
30 weeks - depletion	<p>Manage males by observing bird condition.</p> <p>Remove non-working males to maintain appropriate mating ratios.</p> <p>Monitor and record body weight.</p>
35 weeks - depletion	<p>Female post-peak feed reduction should be started approximately 35 days (5 weeks) after peak production is achieved, which is generally at 252 days (36 weeks) of age.</p> <p>Feed intake should be reviewed weekly and any reductions in feed should be based on feed clean-up time, egg production, daily egg weight, egg mass and body weight.</p>

BIRD HANDLING

Animal welfare and safety are of utmost importance at all times. It is critical that people handling birds are experienced and trained in the correct techniques that are appropriate for the purpose, age and sex of the bird.



Stockmanship

The importance of stockmanship for parent stock welfare, performance and profitability must not be under-estimated. A good stockman will be able to identify and respond to problems quickly.

The stockman must apply and interpret the best-practice recommendations given in this Handbook and use them in combination with their own professional competence, practical knowledge, skills and ability to meet the birds' needs.

The stockman must be constantly in tune with, and aware of, all the birds in the flock and their environment. To do this, the birds' behavioral characteristics and the conditions within the poultry house must be closely observed. This monitoring is commonly referred to as "stock sense" and is a continuous process that uses all the stockman's senses (**Figure 1**). A good stockman must also be empathetic and dedicated, have a good knowledge and skills base, pay attention to detail and be patient.

Figure 1
Stockmanship – using the senses to monitor the flock.

1 Sight

Observe behaviors such as bird distribution in the house and number of birds feeding, drinking, preening, mating and using nest boxes. Observe the environment, such as dust in the air and litter quality. Observe bird health and demeanor, such as posture, alertness, eyes and gait.

2 Smell

Keep notice of smells in the environment, such as ammonia levels. Is the air stale or stuffy?



3 Hearing

Listen to the birds' vocalization, breathing and respiratory sounds. Listen to the mechanical sounds of fan bearings and feed augers.

4 Feel

Handle the birds to assess crop fill and check the birds' general condition (breast conformation, vent and feather condition). Take notice of air movement across your skin. Is there a draft? What does the temperature of the house feel like?

Practical Stockmanship

The body-weight and egg production targets at a given age are usually the same across flocks, but each individual flock will have slightly differing management requirements to achieve those targets. To understand the individual management requirements of a flock and to be able to respond to each flock appropriately, the stockman must know and also sense what is normal for the flock.

The stockman has an important role to play in maintaining the welfare, health and performance of a flock. If only farm records (growth, feed consumption, etc.) are monitored, important signals from the birds and their environment will be missed. Often the first signs of a problem or inadequacy in the environment are subtle changes in bird behavior.

By understanding what is normal for a flock, any changes in behavior or development of abnormal behavior for that flock can be quickly identified. Using all the senses, the stockman must build up an awareness of the environment and an understanding of what the normal behavioral characteristics of the flock are.

This information should be continuously analyzed (in conjunction with the farm records, the stockman's previous experience and knowledge and consideration of the environment the flock is experiencing) to allow any changes or shortfalls in the birds' condition and/or environment to be rapidly identified and corrected.

The flock environment and behavior should be observed at various times of the day by the same person. This observation should be done at any time day-to-day management activities are completed in the house, but, importantly, some specific inspections just to monitor flock behavior should be also made.

Before entering the house, the time and ambient climatic conditions should be noted. This will help determine how the fans, heaters, cool cells and inlets should be operating when compared to the system's set-points.

Upon entry to the house, gently knock on and gradually open the door and ask yourself the following question:

Does the door into the house open with a slight resistance, no resistance or high resistance?

The answer to this question will indicate the air pressure within the house, and reflect the ventilation settings (i.e., inlet openings and fan operation).



Slowly enter the house and stop until the birds become accustomed to your presence. During this time, continuously use all your senses to assess the flock condition. **LOOK, LISTEN, SMELL AND FEEL.**

Figure 2
Using the senses to assess flock condition.

LISTEN TO:

The birds

Are the birds snicking/sneezing? Are their vocalizations appropriate for their age and period of production? How do the birds sound compared to previous visits? Is it a vaccination response or is it related to a dusty, poor environment? Often, listening to the birds is best done in the evening when the noise level is reduced.

The feeders

Are the mechanical augers or chains running constantly and smoothly? Has the daily feed allocation been completely distributed?

The fans

Are the fan bearings noisy? Do fan belts sound loose? Routine maintenance can prevent environmental issues related to suboptimal air quality.

FEEL:

The air

How does the air feel on your face? Is it stuffy (humid), cold, hot? Is there fast air speed or no air speed? These, either in combination or solely, can indicate specific environmental issues, such as insufficient minimum ventilation.

The feed physical quality

Is the crumb very dusty? Do the pellets break down very easily in the hand and in the feeder?

The litter condition

Pick up and feel the condition of the litter. If the litter stays together after compressing (does not spring apart), it indicates excessive moisture, which may suggest ventilation inadequacies. If litter is dry, it will remain friable and fall apart after compressing.

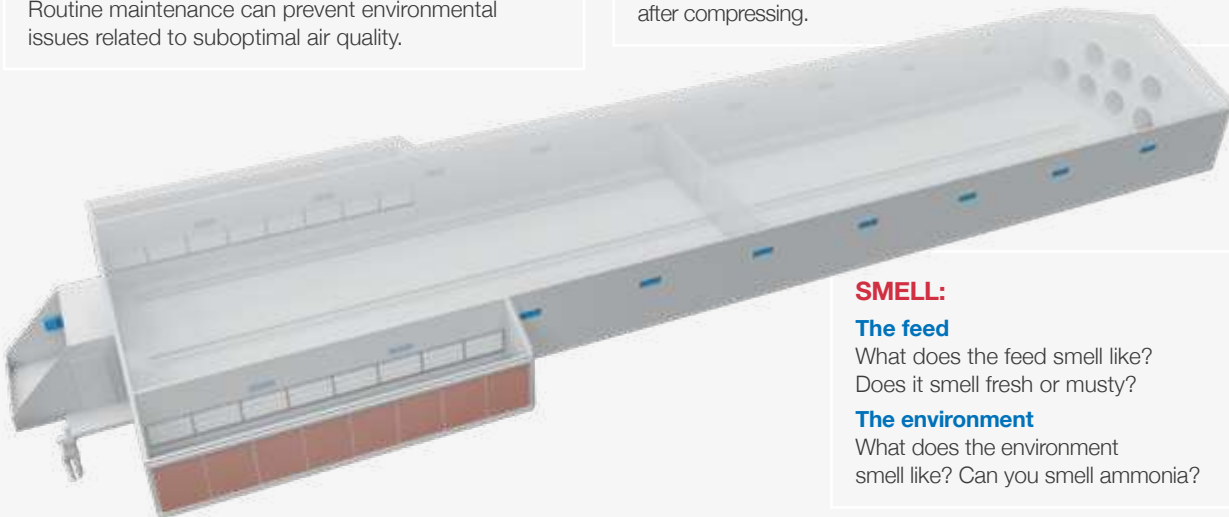

SMELL:

The feed

What does the feed smell like? Does it smell fresh or musty?

The environment

What does the environment smell like? Can you smell ammonia?

LOOK AT:

Bird distribution

Are specific areas of the house being avoided, suggesting an environmental issue (draft, cold, hot, light), or are females avoiding males (incorrect mating ratio)? Has feed been distributed evenly?

Bird respiration

Are the birds panting? Is the panting specific to one area of the house, suggesting an air flow or temperature issue?

Bird behavior

Birds should be feeding, drinking, mating and resting. Ensure behaviors are appropriate for the time of day.

Bird health

Do the birds look healthy upon visual observation? Are there signs of injury or damage to feather cover?

Fans

Are the inlets correctly positioned? Are the heaters running? Do the set-points need adjustment?

Cool cell

Depending on the set-points, is the pad area wet, dry or a combination? Is the water pump functioning and the water being distributed evenly on the pads?

Litter condition

Are areas capping due to leaking drinkers or excess water from cool cells? Is cold air entering the house and falling to the floor?

Feeders and drinkers

Are they the right height? Is there feed in the feeders? Are the drinkers leaking? What is feed quality like? Is there feed spillage?

Nesting area

Are the nests and nest material in good and clean condition? Are birds hiding in the nests? Are the nests soiled or have broken eggs?

Lighting

Are there any dark spots in the house? Are the lights at the correct intensity? Is the timer correct and working? Has the quality of light-proofing been checked?

After the initial entry into the house and observation of the flock and the environment, slowly walk the entire house, assessing the points in **Figure 2**. Walking the entire house is important to ensure that there is minimal variation in the environment and bird behavior throughout the house. When walking through the house, get down to bird level. Pick up any birds that do not move away. Are they sick? How many birds are affected? Assess the way the flock moves in front of and behind you. Do the birds move back to fill the space created by walking through the flock?

Periodically stop to handle and assess individual birds for the following (Figure 3):

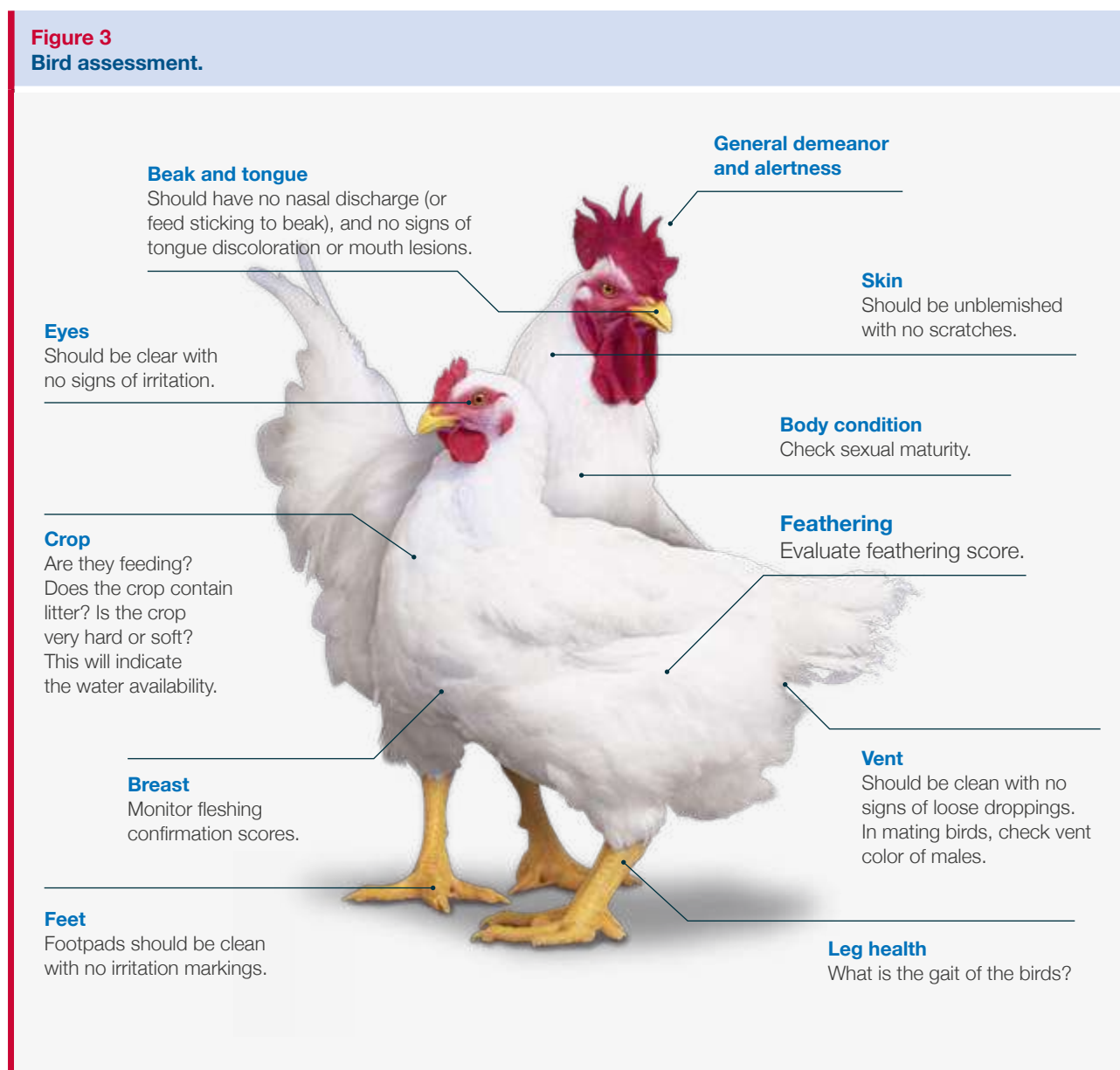

These observations will help build a picture for each individual flock/house.

Remember, no two flocks or houses are the same!

Compare this stock sense information with actual farm records. Are the birds on target? If there are any irregularities, they must be investigated and an action plan should be developed to address any issues that occur.

The Relationship Between Stockmanship and Bird Welfare

Stock sense, combined with the stockman’s knowledge, experience and skills in husbandry will produce a rounded technician who will also have personal qualities such as patience, dedication and empathy when working with the birds. The implementation of the “Three Essentials of Stockmanship” (**Figure 4**) will not only bring the birds as close as possible to the ideal state of “The Five Freedoms of Animal Welfare”, it will strongly influence efficiency and profitability.

Figure 4

Three Essentials of Stockmanship.

(Source: Farm Animal Welfare Committee (FAWC) defined as the ‘ideal state to strive for’).

1 Knowledge of animal husbandry.

Sound knowledge of the biology and husbandry of farm animals, including how their needs may be best provided for in all circumstances.

2 Skills in animal husbandry.

Demonstratable skills in observation, handling, care and treatment of animals, and problem detection and resolution.

3 Personal qualities.

Affinity and empathy with animals, dedication and patience.



Section 1: Rearing (0-105 days/0-15 weeks)

Management Requirements for Males and Females During Rear

Objective

To meet the requirements of male and female parent stock during each stage of rear, and to prepare them for sexual maturity.

Principles

Growing parent stock to the target growth curve in rear allows males and females to achieve optimum lifetime reproductive performance by ensuring that the birds grow and develop correctly. **Figure 5** shows the progression of bird growth and development over time. At different points in time, different organs and tissues will develop. Within each phase of growth, the flock manager should consider, and be aware of, the birds' priorities for growth at that time. Management and feed amounts must be adjusted in response to the birds' needs.

Figure 5
Bird growth and development. The principles of growth and development will be the same for both males and females, but absolute growth rates will be different.

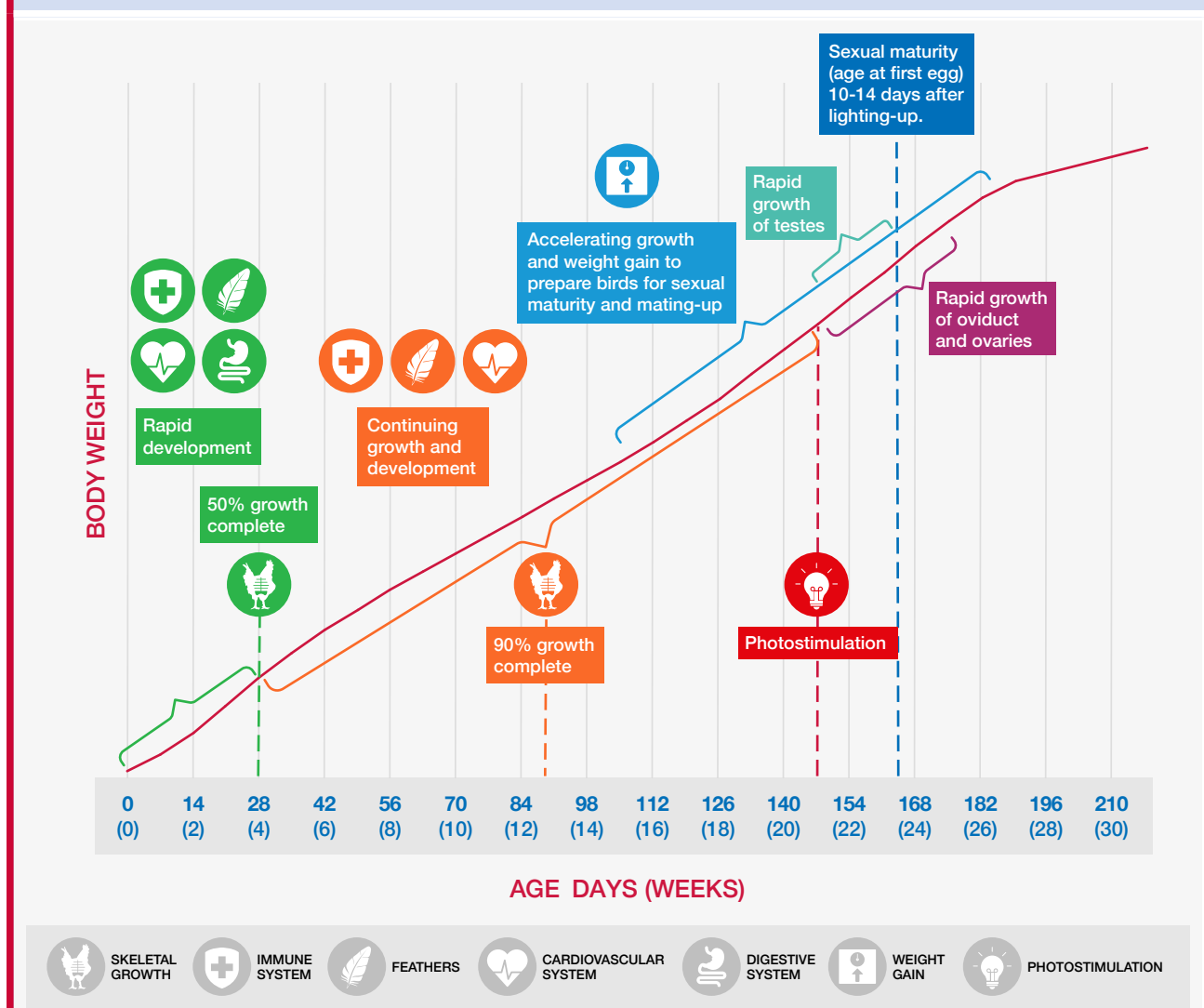

Figure 6
Management progression.

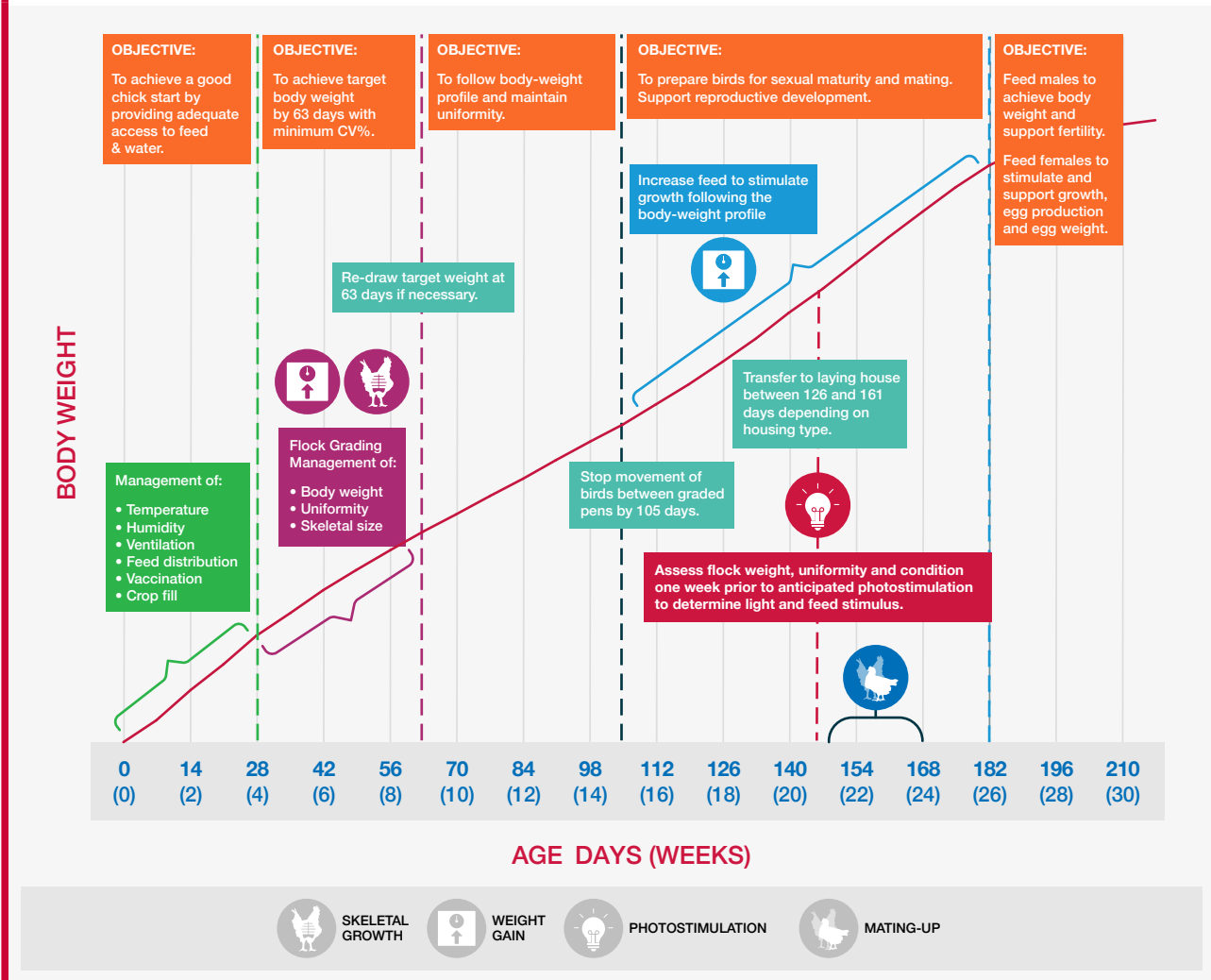

Figure 6 details the important management considerations for each phase of bird growth, illustrated in **Figure 5**.

Males and females should be reared separately from day-old to mating-up at 147-168 days (21-24 weeks of age), but the principles for managing males and females in the rearing period are the same (apart from differences in lighting, body weight and feeding programs). The males form 50% of the breeding value of the flock and are, therefore, just as important as females.

The management of males requires the same attention to detail as that of females. Growing the two sexes separately using separate feeding and drinking systems ensures that growth and uniformity can be managed properly, thus providing more control over body weight and fleshing.

OTHER USEFUL INFORMATION AVAILABLE



Aviagen Poster:
Broiler Breeder Growth Profile



Aviagen Poster:
Uniformity of Female Broiler Breeders

Chick Management

Providing chicks with a good start is essential for the subsequent health, welfare, uniformity and performance of the flock. Chick management should successfully establish the flock from day-old by developing feeding and drinking behavior, and providing the correct environmental and management conditions to adequately meet the requirements of the chick.

Chick Preparations at the Hatchery

Only in circumstances where it is anticipated that the welfare of the birds will be challenged should any preventative procedures be undertaken during chick processing in the hatchery.

In situations where bird health is likely to be compromised or where there is a local disease challenge or local legislation dictates, procedures such as vaccination may be required. Where this is found to be necessary, it is essential that consultation with a veterinarian takes place and that vaccination is only completed by properly trained staff using the correct equipment.

The necessity for any other processing procedures must be regularly reviewed. Processing procedures should only be undertaken after investigations into the birds' environment and management conditions have taken place. Procedures undertaken during chick processing at the hatchery should be completed to the highest standard; variations in the quality of chick handling can lead to welfare problems.

Animal welfare regulations and recommendations are regularly reviewed and updated with regional variations. Regional and national regulations must be followed.

Planning Before Chick Placement

The expected delivery date, location, time and number of chicks should be established with the supplier well in advance of chick placement. This will ensure that the appropriate brooding set-up is in place and that chicks can be unloaded and placed as quickly as possible.

If the stock is being imported, appropriately trained personnel must be available to supervise and liaise with any customs clearance regulation formalities, especially where bird health is likely to be compromised, there is a local disease challenge or to meet local legislation requirements. Chicks should always be held in a dry, sheltered environment at the correct temperature for their welfare.

Chick placements should be planned so that chicks from different-aged donor flocks can be brooded separately. Chicks from young donor flocks will achieve target body weights more easily if kept separate until the time of grading at 28 days (4 weeks) of age.

Chicks should be transported from the hatchery to the farm in an environmentally controlled vehicle (**Figure 7**).

During transportation:

Temperature should be adjusted so that the chick vent temperature is held between 39.4-40.5°C (103-105°F). Note that the required temperature control settings can vary between different vehicle designs.

RH should be between 50-65%.

Fresh air should be supplied at a minimum of 0.71 cubic meters per minute (25 cubic feet per minute) per 1,000 chicks. Greater ventilation rates may be required if the truck is not air-conditioned and ventilation is the only method available to cool the chicks.

The concentration of CO₂ should be less than 3000 ppm.

Figure 7
Typical controlled-environment chick delivery vehicles.



At placement, plan the house set-up for future grading procedures by leaving at least 1 pen empty so that at grading, populations can be grown separately according to their requirements. In situations where coccidiosis outbreaks are a potential concern for the farm, chicks should be placed in all pens.

 **KEY POINTS**

Be prepared - know what is coming and when.

Plan placements so that chicks from different-aged donor flocks can be brooded separately.

Closely monitor the chick holding and transport environments to prevent the chicks from becoming chilled or overheated.

Plan areas for grading.



Farm Preparations for Chick Arrival

Biosecurity

Individual sites should hold birds of a single age and be managed on the principles of “all-in, all-out.” Vaccination and cleaning programs are easier and more effective on single-age sites, with subsequent benefits in bird health and performance.

Houses, the areas surrounding the houses and all equipment (including the water and feed systems) must be thoroughly cleaned and disinfected before the arrival of the litter material and chicks (**Figure 8**). A recommended hygiene program and efficacy testing procedure should be in place to ensure that the correct biosecurity is achieved at least 24 hours before the chicks arrive (see section on *Health and Biosecurity* for further information).

Figure 8
Good house cleaning practices. Power washing the house (most effective with hot water; left), testing the house for bacterial contamination (top right) and disinfecting the exterior with lime (bottom right).



The area surrounding the house should be free from vegetation and be able to be easily cleaned (**Figure 9**). Within the house itself, concrete floors are necessary to allow effective washing, disinfection and litter management.

Figure 9
Houses with a low biosecurity risk showing concrete areas and no vegetation around the immediate perimeter of the house.



Vehicles (**Figure 10**), equipment and people must be disinfected prior to entering the farm.

Figure 10
Methods of disinfecting vehicles before entering a farm.



✓ KEY POINTS

Provide chicks with biosecure, clean housing.

Control spread of disease by using single-age (all-in, all-out) housing.

Follow a recommended hygiene program and have a procedure in place to test its effectiveness.

House Preparation and Layout

For chicks at placement, achieving both correct air temperature and correct floor temperature is necessary for a good chick start. Preheating the house before placement is essential. Temperature (air and floor) and RH should be stabilized for at least 24 hours prior to the chicks being placed. A longer pre-warm (up to 48 hours) may be required if external environmental conditions are cold, or if it is the first flock in a newly built house.

At placement, the environmental conditions required are:

Air temperature of 30°C (86°F), measured at chick height in the area where feed and water are positioned.

Floor temperature of 28°C - 30°C (82°F - 86°F).

Litter temperature of 28°C - 32°C (82°F - 90°F).

RH of 60-70%.

Prior to the chicks arriving, litter material should be spread evenly to a depth of 2-5 cm (0.8-2 in). Where floor feeding is to be practiced after brooding, litter depth should not exceed 4 cm (1.6 in). Litter depth can also be reduced where litter disposal is an issue. Where a thinner layer of litter is used, it is essential that the correct floor temperature (28°C - 30°C [82°F - 86°F]) is achieved prior to chick arrival. Providing more than 5 cm (2 in) of litter can create a problem of litter movement leading to chicks becoming buried, especially if the litter is spread unevenly.

The choice of litter material is influenced by cost and availability, but a good litter material should have the following properties:

Good moisture absorption.

Biodegradability.

Good bird comfort.

Low dust level.

Freedom from contaminants.

Consistent availability from a biosecure source.

At placement, and for the first 24 hours after placement, chicks should not have to travel more than 1 m (3.3 ft) for access to water. Ensure drinker space is correct for the drinker type used (**Table 1**). Water lines should be flushed 1-2 hours prior to chick arrival. Flushing is required if there is a risk of biofilm build-up (e.g., if water soluble additives are added to the water). However, take care to ensure that chicks are never given cold water. The water supplied to the chicks should be approximately 18 to 21°C (64 to 70°F) (**Table 2**). Adapt the water pressure for young chicks, considering manufacturer's guidelines.

Table 1
Recommended drinking space requirements during brooding.

Type of Drinker	Drinker Space
Bell drinkers	8 drinkers per 1000 chicks/ 125 chicks per drinker
Nipples	12 birds/nipple
Mini-drinkers or tray	12 mini-drinkers per 1000 chicks; 9-10 chicks per mini-drinker or tray

Table 2
Effect of water temperature on water intake.

Water Temperature	Water Intake
Less than 5°C (41°F)	Too cold, reduced water consumption
18-21°C (64-70°F)	Ideal
Greater than 30°C (86°F)	Too warm, reduced water consumption
Above 44°C (111°F)	Birds refuse to drink

In hot climates, water temperature should be lower than environmental temperature. Ensure water tanks and pipes are out of direct sunlight and well insulated. It can be advantageous to flush nipple lines at least twice a day for the first 3-4 days to keep the water flow high and the water temperature cool.

After house cleaning and prior to chick delivery, the drinking water should be sampled at the source, at the storage tanks and at drinker points, for bacterial contamination (see section on *Health and Biosecurity* for more information).

Any treatment of water with products (such as water-soluble additives) that could encourage the growth of bacteria in the pipes should be followed by an effective water sanitation program. This program should not affect the birds' performance, even subsequently, when they are in lay (refer to the section on *Health and Biosecurity* for further details). Ensure that all chicks have easy access to feed. At placement, feed should be a sieved crumb (**Figure 11**) or mini pellet (2 mm [0.06 in] diameter) provided on supplementary feeder trays (1 per 80 chicks) and on paper to give a feeding area occupying at least 90% of the brooding area. Paper can provide easier access to feed and the sound of paper can attract the birds' curiosity to find feed. The type of paper used in the brooding area should not easily cake or become slippery.

During brooding, the light intensity should be 80-100 lux (7-9 fc) in the area where the feed and water are positioned to encourage feeding and drinking behavior. The remainder of the house should be dimly lit (10-20 lux or 1-2 fc)

Figure 11
Example of a crumb of good physical quality.



OTHER USEFUL INFORMATION AVAILABLE



Avigen Poster: The First 24 Hours

Spot Brooding

In spot brooding, the heat source (canopy, pancake, radiant heaters and charcoal brooders) is local so chicks can move closer to, or away from, the heat source and select for themselves a preferred temperature. Manufacturers' guidelines should be consulted for equipment positioning and heat output. Brooding rings are used to control early chick movement.

The layout for a spot brooding set-up, which would be typical for 1,000 chicks on day 1, is shown in **Figure 12**. The brooder surround floor should be covered with paper except directly under the brooder.

Chicks should be placed in an area that gives an initial stocking density of around 40 chicks/m² (4 chicks/ft²).

Figure 12
Example of a typical spot brooding layout (1,000 chicks).

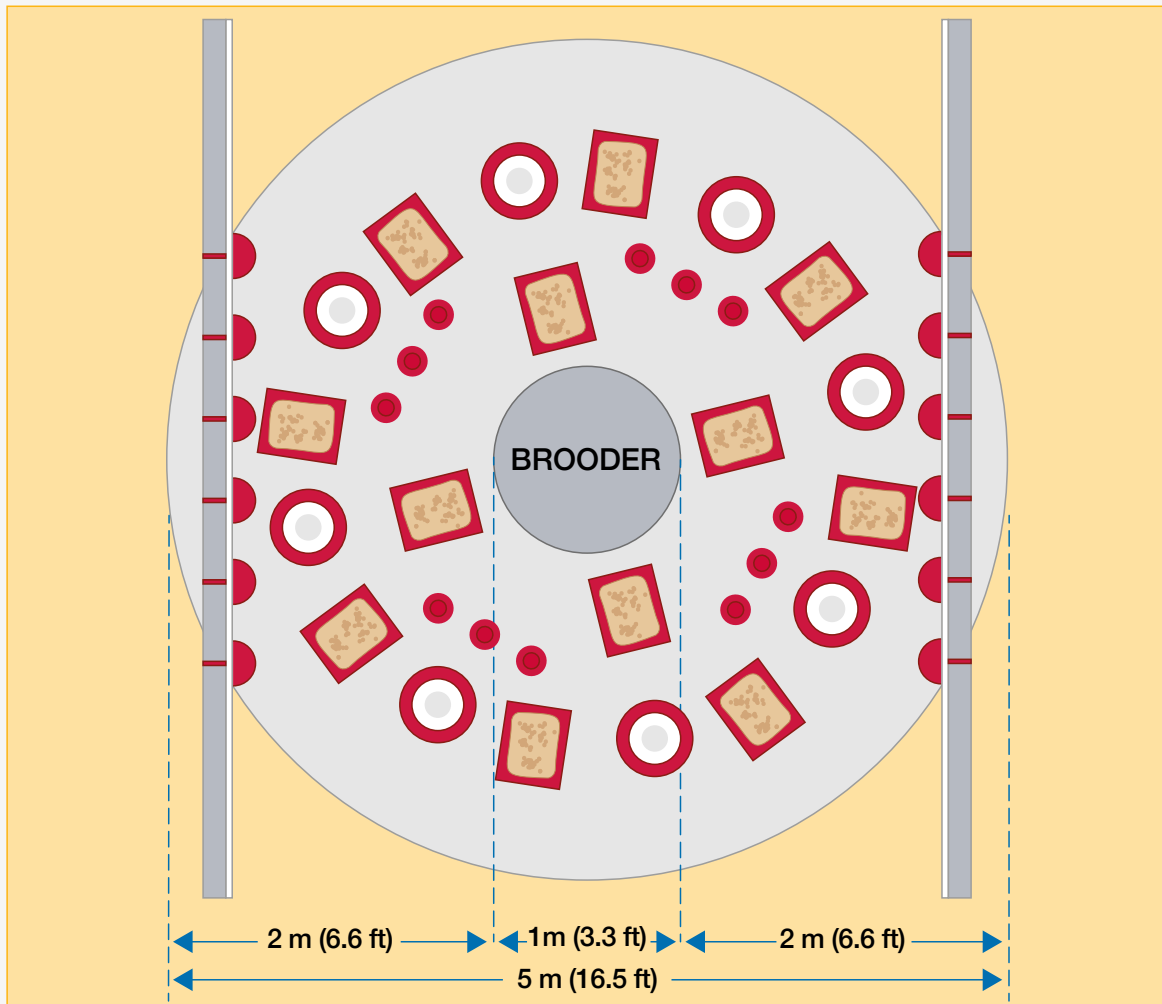

90% Paper Cover	8 Bell Drinkers	12 Feeder Trays	12 Mini Drinkers	Automatic Feeder	Floor Material (e.g. wood shavings)

Whole-house Brooding

In whole-house brooding (**Figure 13**), there is no temperature gradient within the house. House temperature is more constant and the ability of the chicks to move to a preferred temperature zone is limited.

The main heat source for whole-house brooding can be direct or indirect (using hot air), although supplementary brooders might also be provided.

Whole-house brooding can also be done using part of the house only. In this case, the whole house must be heated before releasing the chicks. Heating the whole house will encourage chick movement into the empty area of the house when access is given at around 7 days of age.

Figure 13
Typical whole-house brooding layout for 1,000 chicks.

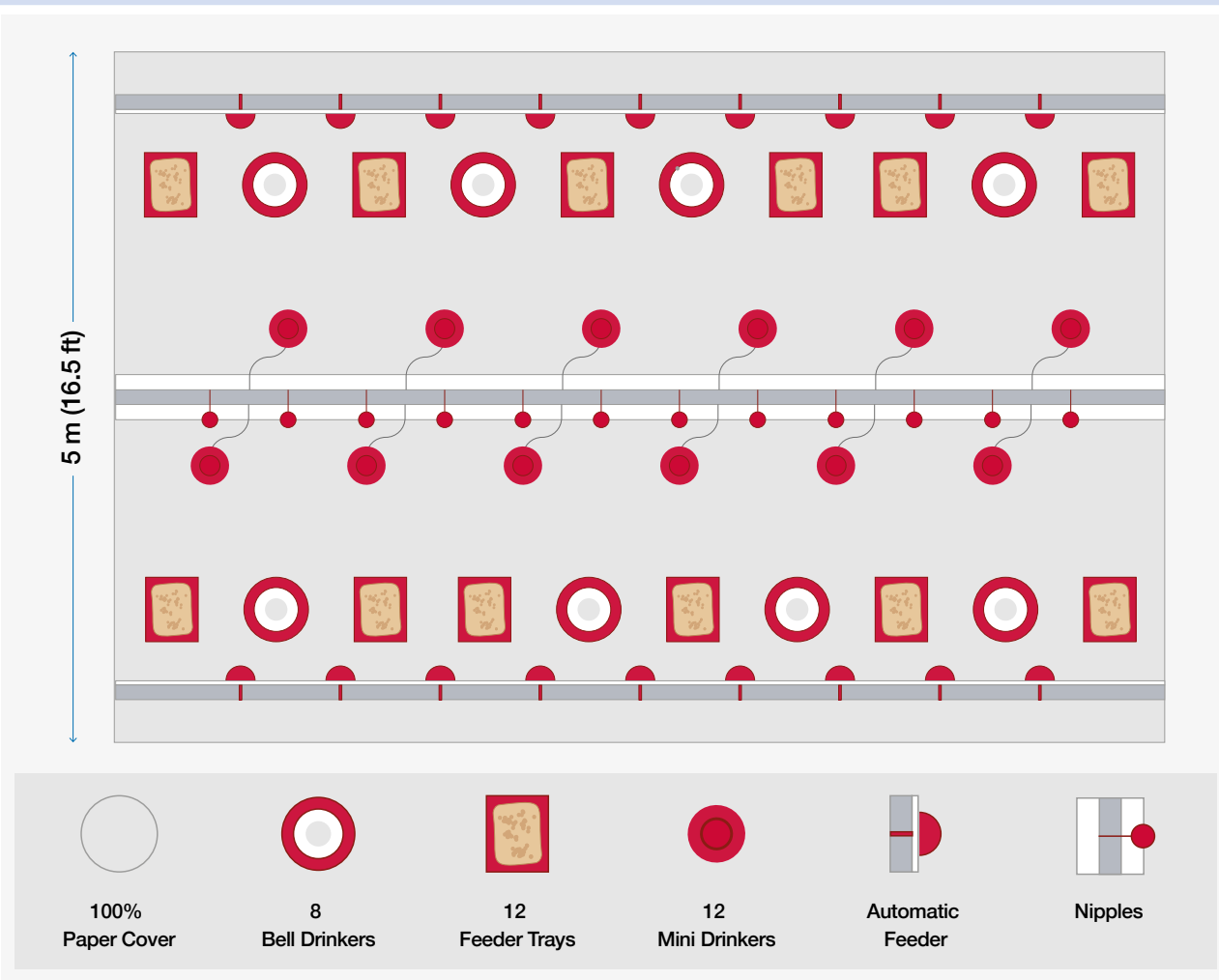

✓ KEY POINTS

Pre-heat the house and stabilize temperature and humidity at least 24 hours prior to chick arrival.

Ensure cleanliness of water and litter.

Arrange equipment to enable the chicks to reach feed and water easily.

Position supplementary feeders and drinkers near the main feeding and drinking systems.

Chick Arrival and Placement

At placement, the chicks should be placed into the brooding area carefully and as quickly as possible (**Figure 14**). Chicks should not stay in the boxes longer than absolutely necessary, as this increases the risk of dehydration, resulting in reduced welfare, poor chick start, uniformity and growth.

After placement, empty cardboard chick boxes should be removed and disposed of without delay. Plastic boxes should be returned for recycling after adequate disinfection protocols have been followed.

Chicks should be left to settle for 1 to 2 hours in their new environment after they have been placed. After this time, a check should be made that all chicks have easy access to feed and water and that environmental conditions are correct. Adjustments should be made to equipment and temperatures where necessary.

Figure 14
Plastic (left) and cardboard (right) chick boxes delivered to a farm from a controlled-environment vehicle.



✓ KEY POINTS

Unload chicks carefully and place them without delay.

Do not leave empty chick boxes lying around.

Check feed, water, temperature and humidity after 1 to 2 hours and adjust where necessary.

Brooding Management

Brooding is the first 7-10 days of a chick's life. Subsequent high levels of flock performance and welfare are dependent upon achieving high standards of management during this period.

It is important to replenish feed and water frequently. During the early stages of brooding (the first 3 days), the maximum daily feed allocation should be provided in small amounts given frequently (i.e., 5-6 times per day). This feeding method will avoid problems of food becoming stale and will encourage chicks to eat.

Open source drinkers (supplementary drinkers and bell drinkers) should be cleaned out and refreshed regularly, as bacteria can multiply rapidly in open water at brooding temperatures. Supplementary drinkers supplied at placement should be gradually removed so that by 3-4 days of age, all chicks are drinking from the automated drinking system.

For the first 2 days, chicks should be provided with 23 hours light and 1 hour dark. After the first 2 days, daylength should be gradually reduced so that it is down to a constant 8 hours by 10 days of age (see section on *Lighting* for more details). In open-sided houses, daylength will depend on date of placement and the natural daylength patterns.

During early brooding, where chick movement is controlled by a brooding ring, the area contained by the rings should be expanded gradually from 3 days of age to increase floor space and improve feeding and drinking space. Actual increases in brooding area should be determined by chick behavior, body-weight gain and feeding, drinking equipment and litter condition. Rings should be removed completely by no later than 10 days of age (**Table 3**). In situations where coccidiosis outbreaks are a concern for the farm, it is beneficial to delay the release of chicks to the full house. Controlling stocking density progressively during the first 3-4 weeks is an excellent way to influence litter humidity and temperature for optimal intestinal development, coccidia sporulation and cycling.

Table 3
Example of increase in brooding area.

Age	Birds/m ² (ft ² /bird)
1-3 days	40 (0.27)
4-6 days	25 (0.43)
7-9 days	10 (1.08)
10 days	Final stocking density

Temperature and RH should be monitored and recorded daily, and appropriate adjustments to the environment made in response to chick behavior to ensure that environmental conditions are optimized.

The number of feeders and drinkers, and the heating capacity of the brooder must be appropriate for stocking density to prevent adverse effects on performance.

Environmental Control

Humidity

Chicks kept at appropriate humidity levels are less prone to dehydration and generally make a better, more uniform start. It is important that house RH levels in the first 3 days after placement are between 60 and 70%.

RH within the house should be monitored daily using a hygrometer. If it falls below 50% in the first week, the environment will be dry and dusty. The chicks will begin to dehydrate and action should be taken to increase RH. RH can be increased by using the misters in the house (**Figure 15**) or a portable backpack sprayer to spray the walls with a fine mist. If increasing RH in this way, care must be taken to ensure that excess moisture is not added to the environment as this will result in reduced litter quality, increased ammonia leading to respiratory diseases and possible footpad and leg issues, coccidiosis and reduced bird performance due to evaporative cooling.

Figure 15
Use of a mister to increase RH during brooding.



Temperature

Optimal temperature and humidity is essential for chick health and appetite development. In both spot and whole-house brooding systems, the objective is to stimulate appetite and activity as early as possible. As chicks cannot regulate their own body temperature very well until 12-14 days of age, provision of the correct environmental temperature and adjusting environmental temperatures appropriately during brooding in response to bird behavior are critical.

A temperature guide appropriate for an RH of 60-70% is given in **Table 4**. With whole-house brooding, particular attention must be paid to monitoring and controlling house temperature and humidity, as the ability of chicks to move to a preferred temperature zone is limited.

With spot brooding, temperature gradients are created within the house. **Figure 16** shows the temperature gradients surrounding the spot brooder. These are marked **A** (brooder edge) and **B** (2 m [6.6 ft] from brooder edge)

brooder edge). Respective optimum temperatures are shown in **Table 4**. Follow manufacturers' recommendations for equipment positioning and heat output.

Table 4
Recommended temperature guide at bird level at an RH of 60-70%.

Age (days)	Whole-House Brooding Temp °C (°F)	Spot Brooding (Refer to Figure 15)	
		Brooder Edge (A) Temp °C (°F)	Brooder Edge (B) Temp °C (°F)
Day-old	30 (86.0)	32 (89.6)	29 (84.2)
3	28 (82.4)	30 (86.0)	27 (80.6)
6	27 (80.6)	28 (82.4)	25 (77.0)
9	26 (78.8)	27 (80.6)	25 (77.0)
12	25 (77.0)	26 (76.8)	25 (77.0)
15	24 (75.2)	25 (77.0)	24 (75.2)
18	23 (73.4)	24 (75.2)	24 (75.2)
21	22 (71.6)	23 (73.4)	23 (73.4)
24	21 (69.8)	22 (71.6)	22 (71.6)
27	20 (68.0)	20 (68.0)	20 (68.0)

Figure 16
Spot brooding temperature gradients.

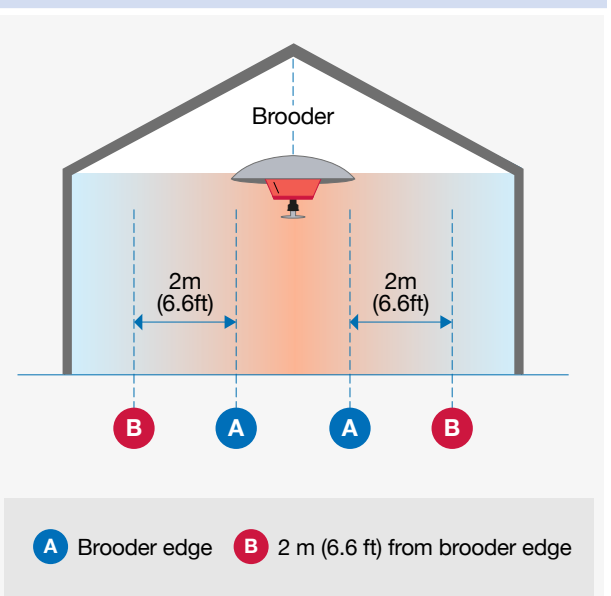

Interaction Between Temperature and Humidity

The temperature experienced by the chick is dependent on dry bulb temperature and RH. Birds lose heat to the environment by evaporation of moisture from the respiratory tract and by conduction and convection of heat. At high RH, less evaporative loss occurs, increasing the animals' apparent temperature. High RH, therefore, increases apparent temperature at a particular dry bulb temperature, whereas low RH will decrease apparent temperature.

The temperature profile given in **Table 4** assumes an RH in the range of 60-70%, but if RH differs from this, optimum temperature may need to be altered accordingly. **Table 5** shows the principles of how the dry bulb temperature required to achieve the target temperature profile given in **Table 4** may alter in situations where RH differs from 60-70%. The figures in **Table 5** are meant as a guide only and the actual change to dry bulb temperature required at differing RH percentages may vary from those given. House temperature at chick level should be adjusted in accordance with chick behavior to ensure chick comfort is maintained.

If behavior indicates that the chicks are too cold or too hot, the house temperature should be adjusted appropriately.

Table 5
Principles of how dry bulb temperatures required to achieve equivalent temperatures may change at varying RH. Dry bulb temperatures at the ideal RH at an age are colored red.

Age (days)	Dry Bulb Temperature at RH%				
	Target	Ideal			
	Temp °C (°F)	40	50	60	70
Day-old	30.0 (86.0)	36.0 (96.8)	33.2 (91.8)	30.8 (87.4)	29.2 (84.6)
3	28.0 (82.4)	33.7 (92.7)	31.2 (88.2)	28.9 (84.0)	27.3 (81.1)
6	27.0 (80.6)	32.5 (90.5)	29.9 (85.8)	27.7 (81.9)	26.0 (78.8)
9	26.0 (78.8)	31.3 (88.3)	28.6 (83.5)	26.7 (80.1)	25.0 (77.0)
12	25.0 (77.0)	30.2 (86.4)	27.8 (82.0)	25.7 (78.3)	24.0 (75.2)
15	24.0 (75.2)	29.0 (84.2)	26.8 (80.2)	24.8 (76.6)	23.0 (73.4)
18	23.0 (73.4)	27.7 (81.9)	25.5 (77.9)	23.6 (74.5)	21.9 (71.4)
21	22.0 (71.6)	26.9 (80.4)	24.7 (76.5)	22.7 (72.9)	21.3 (70.3)
24	21.0 (69.8)	25.7 (78.3)	23.5 (74.3)	21.7 (71.1)	20.2 (68.4)
27	20.0 (68.0)	24.8 (76.6)	22.7 (72.9)	20.7 (69.3)	19.3 (66.7)

The above table shows the influence of RH on the effective temperature of the bird. The temperature actually felt by the bird (effective temperature) is influenced by RH.

For a given temperature:

The birds will feel **cooler** if the RH is **low**.

The birds will feel **warmer** if the RH is **high**.

If the RH is increasing during minimum ventilation, it is most likely because the minimum ventilation rate is insufficient. To correct high or increasing RH, the minimum ventilation rate should be increased and bird comfort re-evaluated before decreasing the temperature set-point.

Monitoring Humidity and Temperature

Temperature and humidity should be monitored at least twice a day for the first 5 days and then daily, thereafter. Measurements of temperature and humidity should be taken at chick level. **Figure 17** indicates the correct positioning of automatic temperature/humidity sensors (above bird head height).

Conventional thermometers should be used to cross-check the accuracy of electronic sensors that continuously record temperature and humidity, and control automatic systems.

Figure 17
Correct location for temperature/humidity sensors.



Ventilation

Ventilation without drafts is required during the brooding period to:

Maintain temperatures and RH at the correct level.

Replenish oxygen.

Remove excess moisture, carbon dioxide and noxious gases produced by the chicks and possibly the heating system.

Poor air quality due to under ventilation at brooding may cause damage to the chicks' lung surface, making birds more susceptible to respiratory disease. Because young chicks are prone to wind-chill effects, the actual air speed at floor level should not be more than 0.15 m/sec (30 ft/min). Any ventilation applied during brooding should not impact bird temperature.

KEY POINTS

Achieve a humidity level of 60-70% for the first 3 days.

Maintain temperature during brooding as recommended.

Adjust temperature according to RH to achieve recommended environmental temperatures.

Monitor temperature and humidity regularly. Check automatic equipment with manual measurements at chick level.

Establish a minimum ventilation rate from day 1 to provide fresh air and remove waste gases.

Avoid drafts.

Respond to changes in chick behavior.

Monitoring Chick Behavior

Temperature and humidity should be monitored daily, but by far the best indicator of correct brooding temperatures is frequent and careful observation of chick behavior.

Spot Brooding Behavior

With spot brooding, correct temperature is indicated by chicks being evenly spread throughout the brooding area as shown in **Figure 18**. Uneven chick distribution is a sign of incorrect temperature or drafts.

Figure 18
Bird distribution and behavior under brooders.

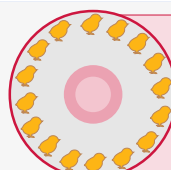

Temperature too high

Chicks make no noise
Chicks pant, head and wings droop
Chicks away from brooder

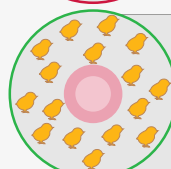

Temperature correct

Chicks evenly spread
Noise level signifies contentment

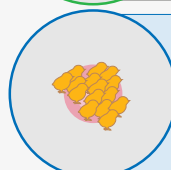

Temperature too low

Chicks crowd to brooder
Chicks noisy, distress-calling

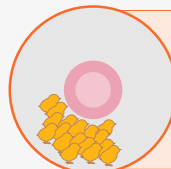

Draft

Chicks huddling in one area of the surround

Whole-house Brooding

In whole-house brooding, monitoring chick behavior is less easy, because there are no obvious heat sources. Often, the chicks' vocalizations may be the only indication of distress. Given the opportunity, birds will congregate in areas where the temperature is closest to their requirements. If environmental conditions are correct, chicks will tend to form groups of 20-30, with movement between the groups, and continuous feeding and drinking will occur. Different distributions of chicks in whole-house brooding at different temperatures are given in **Figure 19**.

Figure 19
Typical distribution of chicks in whole-house brooding (without chick surround) at different temperatures.

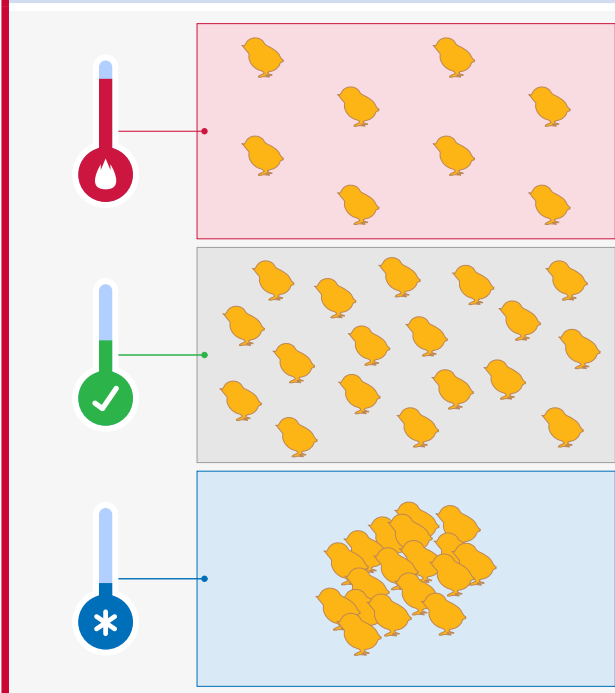

Air Quality

Poor air quality, in particular high levels of CO₂ and CO (>3000 ppm CO₂ and >10 ppm CO), will impact chick behavior. If air quality is poor, chicks may become lethargic and stop eating. It is important to monitor chick behavior for these signs, making routine measurements of air quality and adjusting ventilation accordingly.

✓ KEY POINTS

Closely and frequently observe chick behavior.

Adjust house environment in response to chick behavior.

Chick Start Assessment

Crop Fill

In the period immediately after the chicks are first introduced to feed and water, they are expected to eat, drink and fill their crops. Assessment of crop fill at key times after placement is a useful means of determining early appetite development and checking that all chicks have found feed and water. Crop fill should be monitored during the first 48 hours, but the first 24 hours are the most critical. An initial check 2 hours after placement will indicate if chicks have found feed and water. Subsequent checks at 8, 12, 24 and 48 hours after arrival on the farm should also be made to assess appetite development. It is helpful to do crop fill assessments up to 72 hours after placement to ensure feed intake is continued. Samples of 30-40 chicks should be collected at 3-4 different locations in the house (or per surround where spot brooding is used). Each chick's crop should be felt gently. In chicks that have found feed and water, the crop will be full, soft and rounded (**Figure 20**). If the crop is full, but the original texture of the crumb is still apparent, the bird has not yet consumed enough water. Target crop fills are given in **Table 6**.

Figure 20
Crop fill after 24 hours. The chick on the top has a full, rounded crop, while the chick on the bottom has an empty crop.



Table 6
Target crop fill assessment guidelines.

Time of Crop Fill Check After Placement	Target Crop Fill (% of Chicks with Full Crops)
2 hours	75
8 hours	>80
12 hours	>85
24 hours	>95
48 hours	100

If crop fill is below target then the following points need to be considered:

- Was the house pre-warmed adequately prior to chick placement?

- Were air temperature, litter temperature and RH% correct at chick placement?

- Is light intensity and distribution optimal in the brooding area?

- Are ventilation rates correct and uniform throughout the house?

- Is the air quality satisfactory?

- Do chicks have unrestricted access to feed and water?

- Is at least 90% of the floor covered with paper with feed on?

- Are feeding and drinker space correct?

- Are supplemental feeders and drinkers available?

- Is the starter feed form correct? Have feed amounts been replenished in small frequent amounts?

Vent Temperature

Measuring vent temperature is a good way of determining if environmental conditions are correct for the chicks. In the first 2 days after hatch, vent temperature should be 39.4 to 40.5°C (103 to 105°F). Vent temperature should be measured on at least 10 chicks from at least 5 different locations in the house for the first 2 days after placement. This measurement should combine with stockmanship by assessing behavior and distribution of chicks. Particular attention should be paid to cold or hot areas of the house (e.g., walls or under brooders). To take vent temperature, gently pick up the chick and hold it so that the vent is exposed, put the tip of the electronic thermometer onto the bare skin of the vent and record the temperature (**Figure 21**). Vent temperature should not be taken on chicks with wet or dirty vents.

Figure 21
Taking chick vent temperature.



Monitoring the body temperature of chicks from different areas of the transport vehicle during unloading (5 chicks from one box taken from the rear, middle and front of the vehicle) at the farm can provide useful information about uniformity of temperature and environmental conditions during transport and chick condition upon arrival.

OTHER USEFUL INFORMATION AVAILABLE



*Broiler Breeder Management
How To: Assess Crop Fill*



*Aviagen Video: Managing Flock
Uniformity - Chick Start*



*Aviagen Video: Managing Flock
Uniformity - Crop Fill*

OTHER USEFUL INFORMATION AVAILABLE



*Hatchery How To: Check your Chicks
are Comfortable*



How To Video: Crop Fill



How To Video: Vent temperature

Equipment and Facilities

Optimal flock welfare and performance can only be achieved if the correct amount of floor and feeder space and number of drinkers for bird age and size are given throughout the life of the flock.

Stocking Density

Stocking density, in part, determines the biological output of the flock. Increases in stocking density must be accompanied by appropriate adjustments in environment and management conditions to prevent reductions in biological performance.

Recommended stocking densities during rear are given in **Table 7**. The range of figures quoted represents the variation in conditions from tropical (lower densities) to temperate (higher densities) climates and are intended as a guide.

Actual stocking density will depend on:

Local legislation.

Climate and season.

Type, system and quality of housing and equipment, particularly ventilation, feeders and drinkers.

Quality assurance/certification requirements.

Table 7
Recommended stocking densities during rear (from 10 days onwards)

Rearing 10-105 days (2-15 weeks)

Males Birds/m ² (ft ² /bird)	Females Birds/m ² (ft ² /bird)
3-4 (2.7-3.6)	4-8 (1.4-2.7)

When determining the appropriate stocking density, take into account the actual available bird space. For example, day-old to depletion housing systems can incorporate equipment during the rearing stage such as nest boxes, which will reduce the available bird floor area.

KEY POINTS

Ensure that each bird has adequate floor space for the environment. If the environment and/or housing conditions experienced by the bird are not optimal, reduce stocking density.

Follow the local legislation or codes of practice.

If stocking density is increased, then ventilation settings and feeder and drinker space must also be increased appropriately.

Feeding Space

Bird uniformity and performance will be affected negatively if there is not enough or too much feeding space for the number of birds in the house. Recommended feeding space for males and females is given in **Table 8**.

Table 8
Recommended feeding space.

MALES			FEMALES		
Age (days)	Track Feeder cm (in)	Pan Feeder cm (in)	Age (days)	Track Feeder cm (in)	Pan Feeder cm (in)
0-35 days	5 (2)	5 (2)	0-35 days	5 (2)	4 (2)
36-70 days	10 (4)	9 (3.5)	36-70 days	10 (4)	8 (3)
71-105 days	15 (6)	11 (4)	71-105 days	15 (6)	10 (4)

Track and pan feeder lines should be positioned a minimum of 1 m (3.3 ft) apart to allow uniform and unobstructed bird access to the feeder (**Figure 22** and **Figure 23**). The distance between pan feeders within a line (from center to center) should be a minimum of 0.75 m (2.5 ft).

Figure 22
Uniform distribution of females around a track feeder when adequate feeder space is given.



Figure 23
Uniform distribution of males around a pan feeder when adequate feeding space is given.

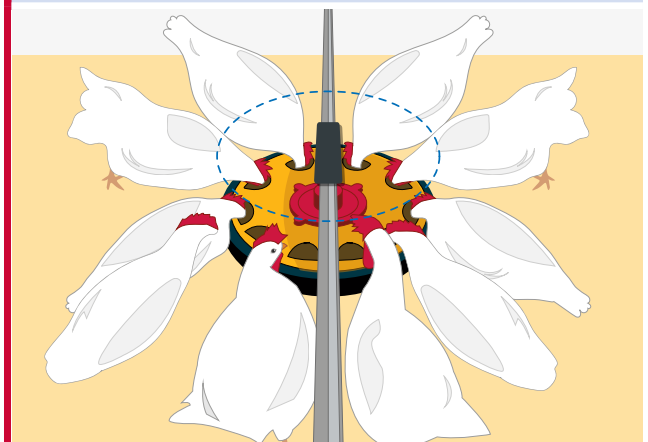

✓ KEY POINTS

Bird uniformity will be negatively affected if feeding space and/or bird distribution are not correct.

Be present at feeding time to ensure correct feed and bird distribution within the house.

Spacing between feeders should allow the birds easy access.

Feeding Management

The first step in feeding management is to install the correct number of feeders, providing adequate feeding space so all birds can eat simultaneously (**Table 8**). This step provides uniform feed distribution and prevents overcrowding at feeders. Feed distribution and feeding behavior must be observed every day by experienced personnel at feeding time.

Where track feeding or pans are used, birds should be gradually introduced to the automated system from 8 days of age onwards. This process should be completed over a 2-3 day period, during which time the volume of feed in the automated feeding system should be increased gradually so that birds become accustomed to the noise of the feeders and associate this with feeding. During this transitional period, manual feeding by hand should continue.

If more than one feeder track is used, then tracks should run in opposite directions. All feed should be distributed to each population within 3 minutes. Make use of a variable speed motor to reduce the speed of the chain when chicks are being trained onto the feeding system. If feed distribution is a problem, distribution time can be reduced by placing a supplementary bin, with sufficient feed to fill half of the track, halfway around the feeder loop. Ensure feed levels in track feeders are monitored and adjusted relative to age and volume by adjusting feeder slides regularly. On all track feeder corners and bins, ensure the openings are well covered.

Pan feeders provide good feed distribution if managed properly. Pan feeding systems remain charged (full of feed) at all times to allow the system to work correctly and pan feeders must be checked regularly to make sure that all pans are receiving feed and that lines remain charged. When birds are young, ensure the pan openings are adjusted to prevent multiple birds from entering the same opening.

Feed depth, distribution time and clean-up time should be monitored routinely at several points around the house. This is to ensure that feed distribution is correct, that all birds have access to the feeders at the same time and that the whole feeding system is being filled correctly. It is best practice to distribute feed in the dark.

Feeder height should be adjusted regularly with bird age and growth. Correct feeder height at a given age should minimize feed spillage, optimize bird access and prevent the feeders from becoming contaminated with litter.

Floor feeding (**Figure 24**) is an alternative to tracks and pans. This method offers rapid and even distribution of feed over a wide area and can improve flock uniformity, litter condition and leg health. For correct feed distribution, spin feeders should be set-up to prevent overlap of feed at walls and pen partitions.

For floor feeding, pen population size should be no more than 1,000-1,500 birds (depending on the pen shape and spinner type). Having feed of good physical quality is particularly important with floor feeding, and a pellet with 2.5 mm (0.094 in) diameter and 3-4 mm (0.125 in) in length should be used. For floor feeding, the transition to pellet feeding must be well managed. Crumb should be fed on feeder trays on the floor until approximately 14 days of age. Crumb and pellet should be mixed and fed on the floor/feeder trays for at least 2 days before birds are given 100% pellets at around 16 days of age, when mechanical spin feeding begins.

Figure 24
Floor feeding using either spin feeders or hand broadcasting.

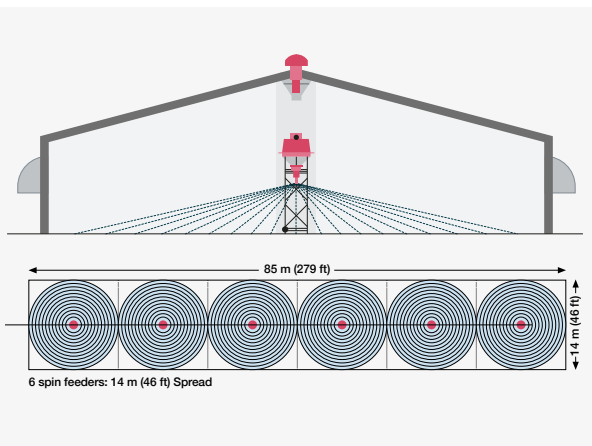

OTHER USEFUL INFORMATION AVAILABLE



Ross Note: The Benefits of Floor Feeding (for Optimal Uniformity)



Broiler Breeder Management How To: Measure Chain Feeder Speed

No matter which feeding system is used, adjustments to feed provision must be made when problems (such as birds becoming overweight, underweight or worsening flock CV%/uniformity) are detected. As the flock increases in age and body weight, feed increases must support the greater nutrient requirements of the heavier birds.

Ideally, feed should not remain stored on the farm for more than a week. Feed bins should always remain covered and be in good condition to prevent water ingress. Any feed spills should be cleaned up promptly.

Use a standard weight to check the accuracy of the feed scales daily before use. Save a sample of feed from each delivery and store it in a cool, dry place. If a problem develops, the feed can then be analyzed.

A visual assessment of every feed delivery should be made. The feed should be assessed on its physical quality, color, appearance and smell. For mash, check that there is good distribution of raw materials throughout the feed.

Physical quality of the feed is important and levels of fines should not exceed 10% for pellets/crums or 25% for mash. Increased levels of fines will have a negative impact on uniformity in early rear. The level of fines within a feed can be measured using a feed shaker sieve.

i OTHER USEFUL INFORMATION AVAILABLE



Aviagen Video: Feed Sieve Demonstration

Drinker Space and Height

Recommended drinking space post-brooding is detailed in **Table 9**. When adequate drinker space is provided, bird distribution around the drinkers will be uniform (**Figure 25**). Regular cleaning is required to ensure the hygiene of open-sourced drinkers.

Table 9
Recommended post-brooding drinking space requirements during rearing.

Type of Drinker	Drinker Space
Bell drinkers	1.5 cm (0.6 in)
Nipples	8-12 birds/nipple
Cups	20-30 birds/cup

Figure 25
Uniform bird distribution around drinkers when adequate drinker space and correct height is provided for bell (left), nipple (middle), and nipple with cups (right).



Check the height of round bell drinkers daily and gradually adjust so that the base of each drinker is level with the birds' backs by approximately 18 days onwards (**Figure 26**).

In the initial stages of brooding, the nipple lines should be placed at a height at which the bird is able to drink. The back of the chick should form an angle of 35-45° with the floor while drinking is in progress. As the bird grows, the nipples should be raised so that the back of the bird forms an angle of approximately 75-85° with the floor and so that the birds are stretching slightly for the water (**Figure 27**).

Birds should be reared on the same drinking system as will be used in production.

Figure 26
Correct height of bell drinker.

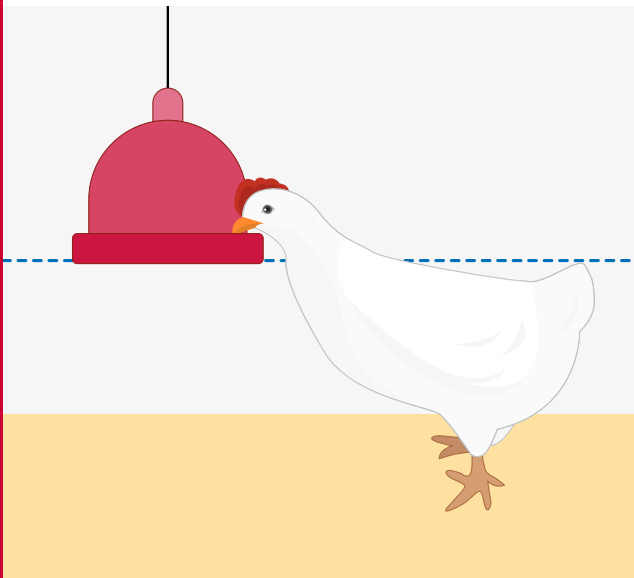
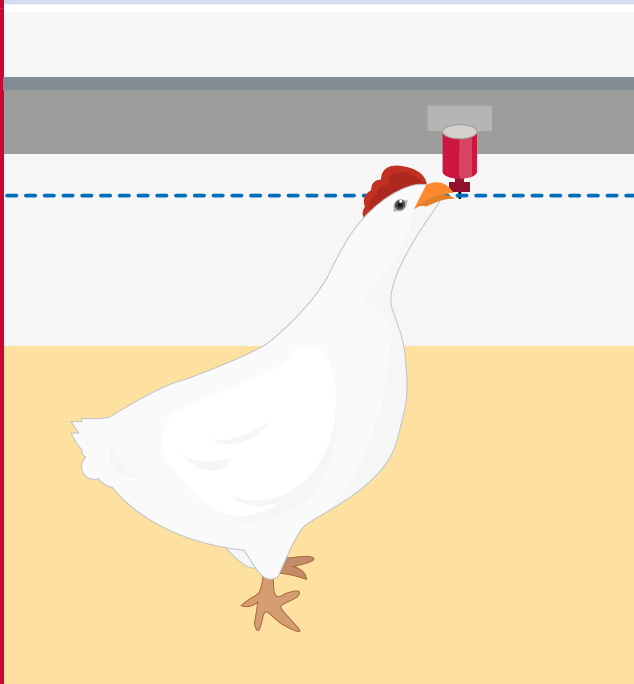

Figure 27
Correct height of nipple drinker.



Drinker management

Optimal water supply is important for birds to grow well and for bird welfare. Birds should have unlimited access to clean, fresh, good quality drinking water at all times. However, when water intake is naturally low, for example during the dark period when birds are inactive, control of water supply may help to reduce unnecessary water leakage. Any control of water should be managed with care; there must be no restriction in the amount of water needed for birds to grow, and a balance must be found between growth and welfare.

Water fit for human consumption should be fit for parent stock. Water from bore holes, open water reservoirs or poor-quality public supplies can cause problems for bird performance and health. Details of water quality criteria for poultry are given in the section on *Health and Biosecurity*. A total water quality test should be completed at least once a year (more often if there are perceived water quality issues).

Where bacterial counts are high, the cause must be established and rectified as soon as possible. Where allowed, treatment with chlorination (to give between 3 and 5 ppm in the drinker farthest from the source) may be required to reduce bacterial load. In regions where chlorination is restricted or prohibited, follow local legislation for the use of approved sanitizers. It is recommended to measure water quality and disinfectant level at the farthest point in the drinker line from the chlorination station.

It is also good practice to disinfect water lines once a month during the life of the flock and flush them a minimum of once a week to maintain good water quality. Storage tanks should also be kept clean and inspected once per month. The storage tanks should be cleaned regularly and after any addition of water treatments, such as vaccines or vitamins.

Where open-sourced drinkers (such as supplementary chick drinkers or round bell drinkers) are used, bacterial contamination can increase rapidly. Therefore, regular and frequent cleaning is needed, especially with young chicks during the brooding stage.

Water consumption measurement is a useful means to monitor system failures (feed and water) and health, and for tracking bird performance. Water intake varies with feed intake and at 21°C (69.8°F), birds should consume a minimum water-to-feed intake ratio of 1.6:1 (depending upon drinker type and environmental conditions). It is important to use crop fill assessment alongside the feed/water ratio recommendations to ensure the water is being utilized by the bird.

Birds will drink more water at higher ambient temperatures. Water requirement increases by approximately 6.5% per degree centigrade over 21°C (69.8°F). In tropical areas, prolonged high temperatures can double daily water consumption.

OTHER USEFUL INFORMATION AVAILABLE



Broiler Breeder Management How To: Measure Nipple Drinker Flow Rate



Broiler Breeder Management How To: Clean the Water System after Depletion



Best Practice on the Farm: Alternative Water Disinfection Methods during Production

KEY POINTS

Birds should have continual access to fresh, clean, drinkable water.

The measurement of water consumption by metering is a vital daily management practice.

Disinfect the water lines once per month.

Inspect storage tanks, cleaning them regularly and after any addition of water treatments.

Test the water supply regularly for bacteriological and mineral contaminants and take any necessary corrective action.

Check and adjust drinkers daily.

Introduction of Perches

It is good management practice to install perches during the rearing period in order to train and stimulate females in nesting behavior (avoidance of floor eggs). Adhere to local legislation and Codes of Practice, but as a minimum, there should be sufficient numbers of perches to provide 3 cm (1.2 in) per bird or sufficient perch space to allow 20% of the birds to roost. Perches should be placed in the pens from the start and made available from 28 days. **Figure 28** illustrates typical perch systems used for training.

Installing perches during rear is also a useful management tool for training males in situations where water is positioned on the slats.

Figure 28
Perch systems used for training.



Best Practice in the Absence of Beak Treatment

Beak treatment, introduced as an aid to prevent damage and mortality as a result of pecking in the 1970s, is now being phased out in many areas.

Beak treatment does not prevent pecking; it merely lessens the impact of pecking should it occur. Pecking is a complex behavioral issue that is the result of re-directed scratching and foraging behavior. As such, the application of appropriate best practice management is key. In areas where beak treatment is no longer permitted, the following management strategies should be followed:

1. Good Stockmanship:

Attention to detail and knowing what is normal and therefore what is abnormal for a flock ensures that potential problems will be detected early and can be dealt with before they develop further.

2. Rear:

- Provide environmental enrichment; the provision of environmental enrichment (such as bales of alfalfa hay or straw, or pecking blocks (ensure good biosecurity) no later than 14 days of age will promote and stimulate foraging and scratching behavior.
- Follow recommended feeding and drinking space advice.
- Consider the use of metal feeders or plastic feeders which have been specifically designed to have a blunting effect on the beak.
- Spin feeding encourages foraging and may also have a natural blunting effect on the beak. If floor feeding, litter depth should not exceed 2-4 cm (1-2 in).
- Follow recommended lighting intensities; achieving uniform light distribution is key. Lighting in rear must be dimmable.
- Adhere to recommended stocking densities; higher stocking densities may increase the potential for pecking issues to occur, particularly if feeding and drinker space is not adhered to.
- Good quality, friable litter must be available from placement. Friable litter will encourage foraging and scratching behavior. If required, actively manage litter to keep it friable.
- Provide a consistent draft-free environment that provides the correct temperature and adequate fresh air to encourage positive behavior and maintain bird welfare. Correct ventilation will also help to maintain litter quality.

3. Lay:

- Consider the use of metal feeders or plastic feeders which have been specifically designed to have a blunting effect on the beak.
- Provide continued environmental enrichment until birds are in production.
- Complete transfer as quickly and efficiently as possible to reduce the challenges that the birds face at this time, and so that changes to the environment are minimal.
- Ensure birds can find feed and water easily and quickly upon arrival.

4. Nutrition:

- Provide adequate nutrition at all ages. In particular, avoid deficiencies in sodium, protein and essential amino acids (especially methionine and cysteine), as well as dietary trace minerals (zinc and selenium).
- Consider implementing strategies to increase clean-up time; feed higher fiber, lower energy diets during rear. Any reduction in dietary energy must be accompanied by appropriate changes in nutrient levels to ensure that the energy-to-nutrient ratios remain the same. Feeding a coarse mash will also increase eating-up time. Feed form changes must be reflective of feeding system used.

If pecking issues do occur, immediate action must be taken to rectify the problem. The development of feather sucking or a lack of feathers in the litter can be one of the first indications of a problem. If either of these issues are seen, immediate action must be taken to prevent the problem from becoming worse. Any corrective management strategies should be applied in combination to achieve the most benefit.

Reduce light intensity. This is only an option if light intensities are not low to begin with.

Analyze feed to rule out dietary deficiency. Implement other management strategies to help combat problems while awaiting receipt of the results.

Provide additional or a change in environmental enrichment.

The addition of sodium bicarbonate (1 kg/1000 L, 2.2 lb/220 gal) water or liquid methionine (0.05 g or 0.002 oz/bird per day) may be beneficial.



OTHER USEFUL INFORMATION AVAILABLE



Aviagen Brief: Management of Broiler Breeders in the Absence of Beak Treatment

Grading to Manage Uniformity

Objective

A uniform flock is easier to manage than a variable one; birds in a similar physiological state will respond more uniformly to flock management factors. The purpose of grading, therefore, is to sort the flock into 2 or 3 sub-populations of different average weights (physiological state) so that each group can be managed in a way that will result in good whole flock uniformity at point of lay (POL).

Principles

Within populations there is always a natural variation in flock uniformity, even at day old. At placement, flock body weights should follow a normal distribution with a low variation (see Day 1 in **Figure 29**). As birds grow, the variation within a flock will increase due to the different responses of individual birds to factors such as environmental conditions, vaccination, disease, differing competitiveness for feed, etc. (**Figure 29**). This increased variation reduces overall flock performance and makes flock management more difficult.

In order to create a uniform flock, smaller, lighter birds as well as larger, heavier birds should be identified, penned and managed separately. The benefits of doing this are illustrated in **Figure 30**.

Minimizing variation within the flock makes flock management easier, as all birds will respond in a similar way to management stimuli such as light and feed.

Figure 29
Example of how flock variation changes over time as a result of natural variation when no flock grading has occurred.

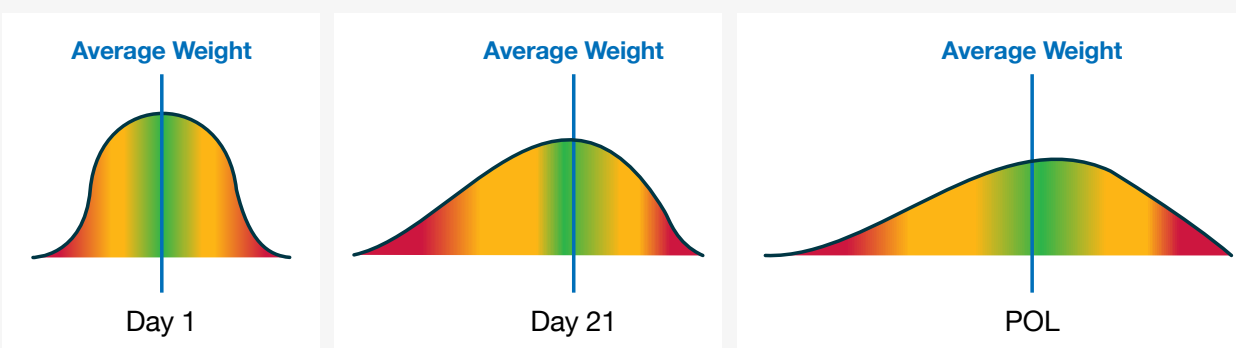
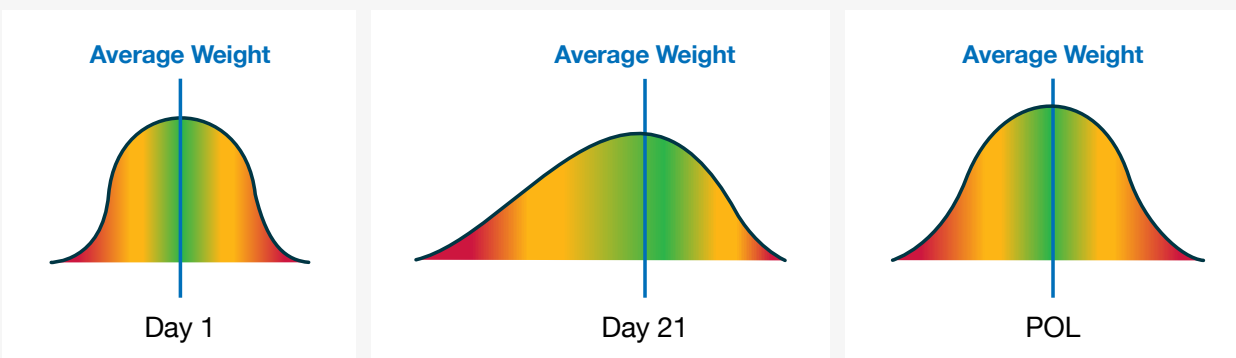

Figure 30
Example of how flock variation changes when the flock is graded at 28 days.



General Procedures for Grading

Grading is a practice that helps to ensure adequate growth and subsequent performance of all individuals. It should be implemented at key ages during the growing period and is achieved by individually weighing the birds (crops should be empty). Grading is best carried out when the flock is between 28 and 35 days (4 and 5 weeks) of age. If completed later than this, the time available to resolve issues and influence skeletal growth (ideally by 63 days) is reduced, and the procedure is less effective. Where uniformity issues persist, it may be appropriate to grade a second time, ideally before 63 days, to manage the individual populations effectively.

Grading is based on the variation in body weight within a flock at the time of grading. A highly variable flock at time of grading, with a large spread of body weights around the average, will need to be split into more sub-populations than a less variable flock. After grading, each sub-population should be managed separately according to its weight with the aim of bringing all populations back to target by POL.

Variation within a flock can be measured in two ways (**Table 10**):

- 1. Coefficient of Variation (CV%)** – this measures the variation (spread) of body weights within the flock; the lower the CV%, the less variable the flock. It is the result of standard deviation divided by average weight.
- 2. Uniformity (%)** – Uniformity is measured by weight +/-10% (ideally) of average weight. It measures the evenness of body weights within a flock; the higher the uniformity, the less variable a flock is.

Table 10
Relationship between CV and uniformity

% Uniformity	95	90	85	79	73	68	64	60	56	52	50	47
Coefficient of Variation CV%	5	6	7	8	9	10	11	12	13	14	15	16

Grading can be done using either measurement of flock variation, and methods for doing so are given in more detail below. However, there are some general principles for grading that are the same irrespective of which strategy is used to grade a flock:

- The actual grading procedure will largely depend on the farm/house design and management practices (e.g., flexibility of pen arrangements and feeding systems) and the variation in body weight within the flock at 28-35 days. Ideally, house set-up at placement should account for the need to grade later in the flock with at least 1 pen left empty at placement (**Figure 31**). In situations where coccidiosis outbreaks are an issue, it is better to have all pens occupied by birds. Controlling stocking density progressively during the first 3-4 weeks influences litter humidity and temperature for optimal intestinal development, coccidia sporulation and cycling.

Figure 31
Pre-grade house set-up for 2-way grade with adjustable penning.

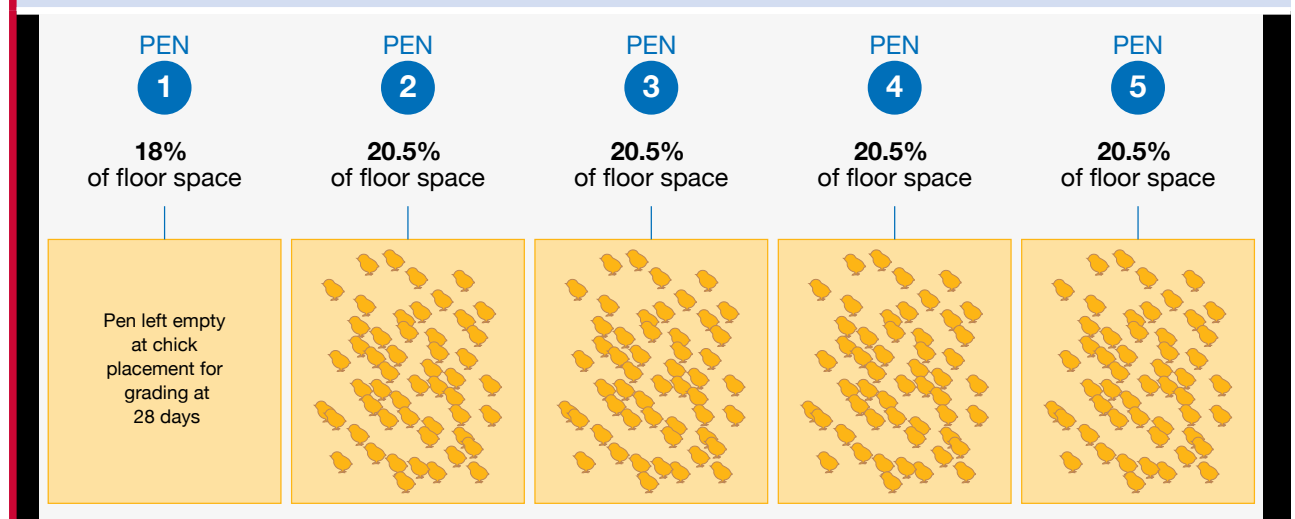

2. Space allocated for both male and female flocks must be capable of being divided into 2 or 3 pens/populations. Where the entire population of a house is to be graded within that house, then ideally 1 or 2 adjustable partitions will be required to allow the flock to be segregated.
3. Prior to grading, a sample of birds from the population should be weighed and the variation within the flock (as measured by CV% or uniformity) assessed. A minimum sample size of 50 birds, or 2% of the population, whichever is greater, is recommended. Flock CV% or uniformity can then be used to determine the grading cut-off points (the number and average weight of birds that will be graded into each population). The target CV% should be equal to or less than 8, or a uniformity of 80% or more before laying begins. Aviagen's preference is to use electronic scales that record and count individual weights, and automatically calculate the CV% and uniformity of the population. If electronic scales are not available and weights are recorded manually, please refer to the example given in **Appendix 4**. A minimum sample of 2% of the population (or 50 birds, whichever is greater) should be weighed. If more birds than this are caught, they should all be weighed to avoid selective bias. Regular calibration of weighing equipment should be completed prior to grading to ensure accuracy of the data.
4. After grading, it is important to re-weigh a sample of birds from each pen or population (a minimum of 2% or 50 birds, whichever is greater) and establish the average body weight, the variation around that average as measured by CV% or uniformity and number of birds for each pen. After grading, the variation in body weight within the graded populations should have improved.
5. It is essential that stocking density and feeding and drinking space are maintained in line with recommended guidelines in the graded populations. Each population should have its own dedicated feeding system. Where this is not possible, supplementary feeding systems must be installed to allow even distribution of feed and adequate feeding space per bird.
6. The body weights from graded populations should be plotted against targets and the profiles redrawn where necessary. Manage birds towards target body weights from grading to 63 days (9 weeks) of age. Adjustment in feed levels should be based on the deviation in body weight from target.

Grading Using CV%

Houses with Adjustable Penning

From each pen/population, a random sample of birds (a minimum of 2% or 50 birds whichever is greater) should be caught in a catching pen and weighed.

Table 11 provides the grading cut-off points (i.e., the percentage of birds that will be graded into each population), according to flock CV%. These cut-offs apply specifically when adjustable penning is available in the house.

Figure 32 illustrates a post-grading house set-up for a 2-way grade with adjustable penning. **Figure 33** gives an example of a printout produced from electronic scales and shows how it can be used to establish the cut-off points for grading when a 3-way grade is required.

If a 2-way grade is required (i.e., flock CV% is lower than 10), the cut-off points provided in **Table 11** and the information from the electronic scale print out can be used to establish the cut-off weights for the 2 graded populations in the same way as was done in the example for a 3-way grade above.

Table 11
Grading cutoffs when using CV%.

Flock Uniformity CV%	Percentage in Each Population after Grading			
	2 or 3-way grade	Light (%)	Normal (%)	Heavy (%)
8-10	2-way grade	20	~ 80 (78-82)	0
10-12	3-way grade	22-25	~ 70 (66-73)	5-9
>12	3-way grade	28-30	~ 58 (55-60)	12-15

Figure 32
Post-grade house set-up for 2-way grade with adjustable penning.

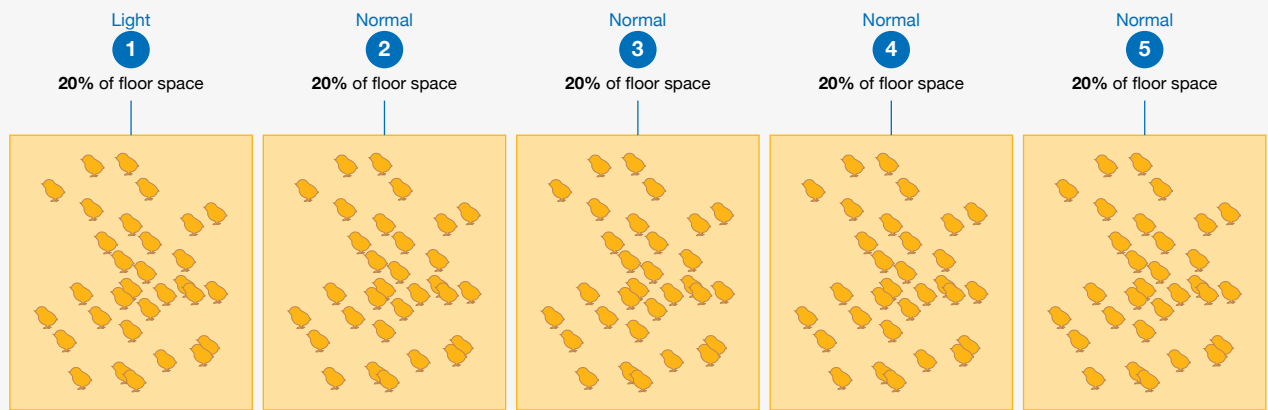

Figure 33
Example of a print-out from an electronic scale for a 3-way grade with adjustable penning.

CURRENT DATA METRIC	
TOTAL WEIGHED:	200
AVERAGE WEIGHT:	0.459
DEVIATION:	0.056
C.V. (%)	12.3

Band limits	Total
0.320 to 0.339	3
0.340 to 0.359	7
0.360 to 0.379	11
0.380 to 0.399	15
0.400 to 0.419	20
0.420 to 0.439	14
0.440 to 0.459	30
0.460 to 0.479	27
0.480 to 0.499	23
0.500 to 0.519	20
0.520 to 0.539	16
0.540 to 0.559	9
0.560 to 0.579	5

CURRENT DATA IMPERIAL	
TOTAL WEIGHED:	200
AVERAGE WEIGHT:	1.01
DEVIATION:	0.123
C.V. (%)	12.3

Band limits	Total
0.705 to 0.747	3
0.750 to 0.791	7
0.794 to 0.836	11
0.838 to 0.880	15
0.882 to 0.924	20
0.926 to 0.968	14
0.970 to 1.012	30
1.014 to 1.056	27
1.058 to 1.100	23
1.102 to 1.144	20
1.146 to 1.188	16
1.190 to 1.232	9
1.235 to 1.276	5

Flock details	kg	lb
Age	28 days	28 days
Target weight	0.450	0.99
Average weight	0.458	1.01
Total birds weighed	200	200

Based on this flock sampling data, a 3-way grade is required as detailed below; i.e., flock CV% is above 12 (see **Table 11**).

Cut off points and number of birds in each group:

	% of Birds	Number of Birds*
Light Birds	28	56
Average Birds	57	114
Heavy Birds	15	30

*Number of birds = (% birds ÷ 100) x total birds weighed

The **light**-graded population will be approximately 24% of the entire flock. Of the 200 birds weighed, the lightest 28% (or 56 birds) are in the weight range of 0.320 to 0.419 kg (0.71 to 0.92 lb).

A **light** bird will therefore be a bird weighing **less than or equal to 0.419 kg (0.92 lb)**.

Using the same process, the cut-off weights for the average and heavy populations can also be determined.

The **average** population will therefore be in the weight range of **0.420 to 0.519 kg (0.93 to 1.14 lb)**.

The **heavy**-graded population will be any birds that is **0.520 kg (1.14 lb) or heavier**.

Houses with Fixed Penning

In houses with non-adjustable or fixed penning, the pens are set in place at the start of the flock in each house. Pens will be equally divided across the house and the graded populations will need to be split evenly across the available pens. For example, if there are four separate pens, 25% of the population will need to be housed in each pen; grading cutoffs and cut-off weights will need to be adjusted to account for this. See **Appendix 3** for more information.

Grading Using Uniformity

Houses with Adjustable Penning

The uniformity of a flock is expressed as the percentage of birds that fall within a given range (ideally +/- 10%) around the average body weight of the flock. The higher the number of birds that fall within this body-weight range, the more uniform the flock and the less grading it will require (**Table 12**). Grading is still recommended even if flock uniformity is 80% or above.

Table 12
Grading cutoffs when using uniformity to grade.

Uniformity	2 or 3-way Grade
68% - 79%	2-way grade
68% or lower	3-way grade

An example of how to use uniformity to complete a 3-way grade of a flock is given in **Figure 34**.

Figure 34
Example of a print-out from an electronic scale for a 3-way grade using uniformity % and when adjustable penning is available.

CURRENT DATA METRIC		CURRENT DATA IMPERIAL		Flock details		
TOTAL WEIGHED:	200	TOTAL WEIGHED:	200	Age	28 days	28 days
AVERAGE WEIGHT:	0.459	AVERAGE WEIGHT:	1.01	Target weight	0.450	0.99
DEVIATION:	0.056	DEVIATION:	0.123	Average weight	0.458	1.01
C.V. (%)	12.3	C.V. (%)	12.3	Total birds weighed	200	200
Band limits	Total	Band limits	Total	Ideal body weight range assumed to be +/-10% of average sample weight.		
0.320 to 0.339	3	0.705 to 0.747	3	10% of average sample weight = 0.1 x 0.459 kg (0.98 lb) = 0.046 kg (0.101 lb)		
0.340 to 0.359	7	0.750 to 0.791	7	Therefore,		
0.360 to 0.379	11	0.794 to 0.836	11	+10% of average weight = 0.459 kg + 0.46 kg (1.01 lb + 0.101 lb) = 0.505 kg (1.11 lb)		
0.380 to 0.399	15	0.838 to 0.880	15	-10% of average weight = 0.459 kg - 0.46 kg (1.01 lb - 0.101 lb) = 0.413 kg (0.91 lb)		
0.400 to 0.419	20	0.882 to 0.924	20			
0.420 to 0.439	14	0.926 to 0.968	14			
0.440 to 0.459	30	0.970 to 1.012	30			
0.460 to 0.479	27	1.014 to 1.056	27			
0.480 to 0.499	23	1.058 to 1.100	23			
0.500 to 0.519	20	1.102 to 1.144	20			
0.520 to 0.539	16	1.146 to 1.188	16			
0.540 to 0.559	9	1.190 to 1.232	9			
0.560 to 0.579	5	1.235 to 1.276	5			

114 birds out of 200 weighed are within the weight range that is +/- 10% of the average body weight (0.413-0.505 kg [0.91-1.11 lb]), highlighted blue in the electronic print-out. Uniformity is therefore 57%.

As uniformity is less than 68%, a 3-way grade is required (see **Table 12**).

Light birds will be those that weigh **0.413 kg (0.91 lb)** or less (-10% of the average sample weight).

Average birds will be those that weigh **0.414-0.504 kg (0.91-1.11 lb)**.

Heavy birds will be those that weigh **0.505 kg (1.11 lb)** or heavier (+10% of the average sample weight).

If a 2-way grade is required (i.e., flock uniformity is 68% or greater), the information from the sample weighing can be used to establish the cut-off weights for the two graded populations in the same way as was done in the example for a 3-way grade above.

Houses with Fixed Penning

If grading using fixed (non-adjustable) penning is the only option available, it will be necessary to adjust the grading cutoffs and cut-off weights to account for pen size. This adjustment will need to ensure that the correct number of birds are placed in each pen so as to maintain recommended stocking density. For more information, please refer to *Appendix 4*.

KEY POINTS

Grade males and females at 28-35 days (4-5 weeks).

It is recommended to use electronic rather than manual weigh scales.

A successful grading will reduce the variability of the graded populations to be better than that of the original population and ideally to a CV% less than or equal to 8 or a uniformity of above 80%. Each population should be re-weighed and counted to confirm the average body weight and uniformity/CV% so projected target body weights and feeding rates can be determined.

Inaccurate counting of birds after grading may lead to incorrect feed quantities being given.

Each population is best served by its own dedicated feeding system. Where this cannot be provided, supplementary feeding must allow even distribution of feed and adequate feeding space per bird.

Ensure that stocking density, drinking and feeding space are consistent with the recommended guidelines after grading; this is especially important where pen size is adjusted during grading.

Flock Management After Grading (Post 28 Days)

After grading, the flock must be managed so that graded populations achieve target weight in a uniform and coordinated manner.

Although the grading of birds into individual pens is a key management strategy, post-grading management to maintain flock uniformities within graded pens is of equal importance and particular detail must be paid to the management of individual populations from 35 days onward. If population sizes in lay are likely to be larger than they were in rear, birds will have to be mixed at transfer. Here it is especially important that management after grading results in the birds converging to a common target body weight by the expected age of transfer.

Post-Grading Feed Levels

Post-grading feed levels should be adjusted to individual pen and graded bird body weights to bring each population gradually back to the target line.

Feed volume levels must be recalculated on a weekly basis calculating for changes in livability.

Base feed levels on individual pen body-weight gain and bird numbers.

Feed levels should NEVER be reduced.

For light bird pens, feed levels should remain the same as the week prior to grading for 1 week post-grading. Reduced competition from heavier birds after grading means an initial increase in feed is not normally required. Likewise, body weight of heavy birds should be closely monitored to make sure their feed allocation is not reduced.

Do not hold feed at a constant level for longer than 10 days.

Unexpected changes in body weight (ensure body weight is accurate and measured with calibrated scales) may be due to incorrect feed allocation, changes in feed composition/ingredients or a change to a different feed type, and must be investigated immediately.

Post-Grading Body-Weight Management (Up to 63 Days of Age)

At grading, the flock will have been divided into 2 or 3 populations, depending on the original CV% or uniformity. For each graded population, the aim is to achieve the target body weight uniformly within the period during which skeletal development is taking place (i.e., before 63 days of age). After 28 days of age, the weekly body weights of each population must continue to be monitored and feed allocations adjusted as necessary to allow the required body-weight targets to be met.

Under-target-weight Birds (Light Population)

Where the average body weight after grading for a population or pen is below target body weight, the objective is to redraw the body-weight curve so that target body weight is achieved by 63 days (Figure 35). For the first week after grading, the light population should be held on the same feeding volume as that prior to grading (i.e., do not increase feed levels). Body weight will be increased due to the reduced competition from the larger birds. Subsequent appropriate increases in feed should then be based on the deviation from target body weight.

On-target-weight Birds (Average Population)

The aim is to continue to keep birds on target (Figure 35).

Over-target-weight Birds (Heavy Population)

These are birds that are greater than the target body weight. Here the body-weight curve should be redrawn to reduce growth so that birds are gradually managed towards the target body weight by 63 days (Figure 35). Feed levels should never be reduced, but it may be necessary to reduce the size of the next feed increment or delay the next feed increase in order to achieve the revised body-weight profile.

Figure 35
Redrawing of future body-weight targets up to 63 days (9 weeks) of age.

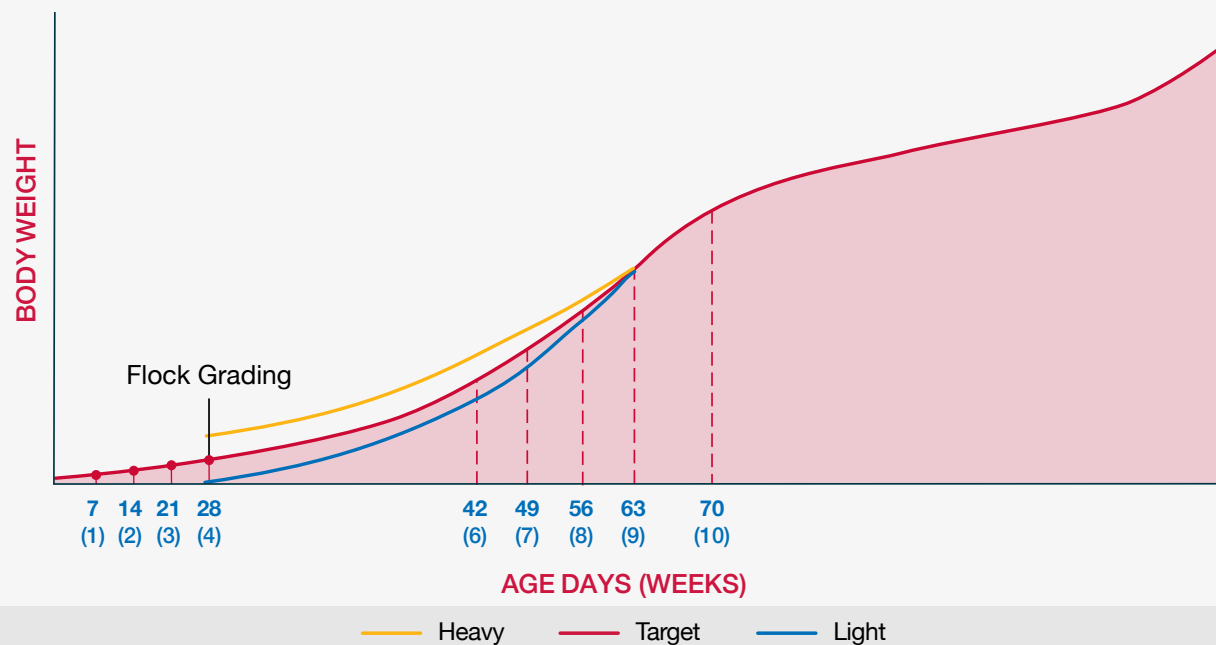

Post 63 Days Redrawing of Future Body-Weight Profiles

At 63 days of age, the weight of the population in relation to the target should be re-assessed. Populations that are of similar weight and feed consumption can be combined at this age.

Under-target-weight Birds (Light Population)

If birds remain under target at 63 days (9 weeks), the target should be redrawn so that birds are brought back onto target profile gradually (**Figure 36**), achieving body weight by 105 days. Feed levels should be increased or the next feed increase brought forward to achieve this.

On-target-weight Birds (Average Population)

The aim is to continue to keep birds on target (**Figure 36**).

Over-target-weight Birds (Heavy Population)

If birds remain overweight at 63 days (9 weeks of age), the target should be redrawn so that birds are brought back onto target profile gradually (**Figure 36**), achieving body weight by 105 days. Birds should be fed the level of feed required to achieve the revised target profile.

Figure 36
Redrawing of future body-weight targets when average body weight is below, on, or above target at 63 days (9 weeks) of age.

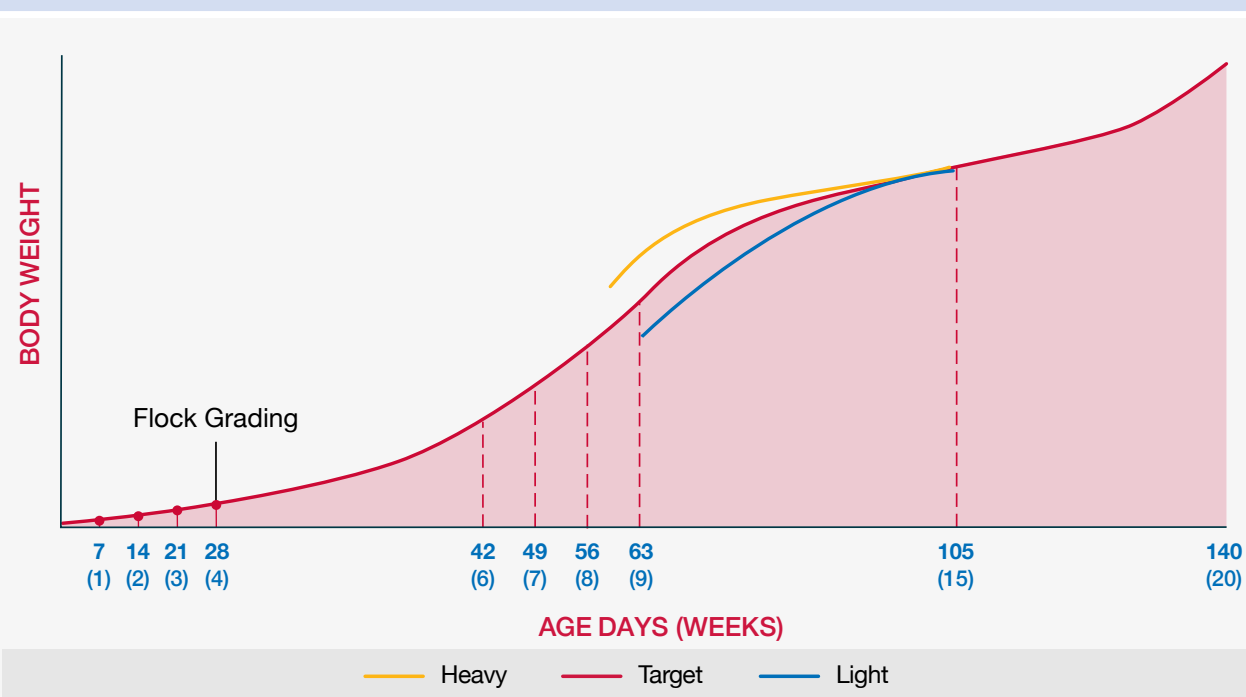

✓ KEY POINTS

Continue weekly body-weight monitoring.

From 63 days, redraw the target weights of any population that is above/below target body weight to manage them towards the target by 105 days of age.

Before mixing any pens, ensure body weight and consumption per bird are similar.

Alleviation of Body-Weight Problems

If the average body weight differs from target body weight during rear, re-weigh a sample of birds. If the weights are accurate, refer to the information in **Table 13** and consider the following:

Underweight prior to 105 days, consider the following in future flocks:

Remain on starter feed for longer.

Feed a higher nutrient quality starter.

A longer daylength can be provided until 21 days (3 weeks) of age to help stimulate feed intake and improve body-weight gain.

Underweight prior to 105 days, consider the following in current flocks:

Initiate the next feed increase earlier and consider increasing the amount if necessary, until body weight is brought gradually back to target.

See **Figure 35** and **Figure 36** for examples of such corrective action.

Overweight prior to 105 days:

Do not reduce feed lower than the current feeding level.

Reduce the next feed increment, e.g., 2 g per bird (0.44lb per 100 birds) instead of 4 g per bird (0.88 lb per 100 birds).

Delay the next feed increase.

Check to see if the energy level of the diet is higher than expected.

See **Figure 35** and **Figure 36** for examples of such corrective action.

Any changes made to alleviate body-weight problems should be made gradually, ensuring average body-weight gains are made each week. Once feed adjustments are made, it can take 2-3 weeks to see a response in rate of growth.



Table 13: Identifies further key areas associated with population management post-grading.

Table 13 Key areas of management post-grading.			
Item	Comment	Actions	Supporting Information
Stocking Density	Number of birds per m ² /or ft ² per bird. Bird stocking density must remain equal within each graded pen and follow recommendations.	Adjustable pens - Increase or decrease pen area to maintain the recommended stocking density for age.	Stocking Density Table - Table 7 page 30.
		Fixed pens - Adjust bird numbers within each pen to maintain the recommended stocking density for age.	Stocking Density Table - Table 7 page 30.
Light Intensity	Lux/Foot Candle (fc). Light intensity should be uniformly distributed throughout each pen at bird level and avoid shaded areas.	<p>Ensure all light bulbs are set at an equal and uniform distance from the floor.</p> <p>Ensure all bulbs are in good working order, are clean and emit the same level of intensity.</p> <p>Avoid the use of unidirectional light bulbs (old-style LED bulbs or spot lights).</p> <p>Avoid the use of low-intensity (high flicker rate) fluorescent tubes.</p>	Environmental Requirements - Table 26 page 124.
Feeding Space	Birds per feeder/cm (in) of feeding space per bird. Available feeding space should be maintained at recommended levels and adjusted for bird age and number throughout the rearing period and into production.		
	Pan feeders (loop or straight line)	<p>Ensure adequate distance between feeder pan centers (min 0.75m/2.5 ft).</p> <p>Each graded population should have its own dedicated feeding system where possible to allow accurate feed amounts to be given. If not, then the whole house population should be fed to the lowest feed amount per bird (usually the large bird population), and any extra feed needed should be added by hand and evenly distributed between all feeders.</p> <p>Follow recommended feeding space per bird throughout rear.</p> <p>Ensure feed allocation settings per pan (feed volumes) are equal to allow a uniform distribution of feed throughout the house.</p> <p>Distribute feed in the dark where possible to allow instant access to feeders when lights are turned back on.</p> <p>Adjust number of pans in adjustable penning if bird numbers change.</p> <p>Ensure feeder height is correct and adjusted for age.</p> <p>Ensure feed is distributed within 3 minutes.</p>	Feeding Space Table - Table 8 page 31.

Table 13
Key areas of management post-grading.

Item	Comment	Actions	Supporting Information
Feeding Space	Track feeders	<p>Ensure recommended feeding space per bird is maintained throughout the rearing period.</p> <p>For adjustable penning, adjust track length for any changes in bird number per pen.</p> <p>Ensure correct depth of feed to allow uniform feed distribution along whole length of track.</p> <p>Each graded population should have its own dedicated feeding system, where possible, to allow accurate feed amounts to be given. If not then the whole house population should be fed to the lowest feed amount per bird (usually the large bird population) and any extra feed needed should be added by hand and evenly distributed along the available track.</p> <p>Ensure feed is distributed within 3 minutes.</p> <p>Distribute feed in the dark where possible to allow instant access to feeders when the lights are turned back on.</p> <p>Ensure feeder height is correct and adjusted for age.</p>	Feeding Space Table - Table 8 page 31.
	Floor/spin/hand feeding	<p>Ensure any spin feeders are calibrated correctly to allow correct amount of feed per bird. Spin feeders should be set-up to prevent overlap of feed at walls and pen partitions, when distributed.</p> <p>Check that floor area is covered uniformly with pellets to allow all birds to eat uniformly and that stocking densities within each pen are correct for age of birds. Ensure pellets are of good durability for floor feeding.</p> <p>Ensure litter depth is within recommendations.</p>	<p>Stocking Density Table - Table 7, page 30.</p> <p>Litter Depth - Section 1, page 20. House Preparation and Layout</p> <p>Pellet Durability - Section 1, page 31. Feeding Management</p>
Drinker Management	Number of birds per drinker (nipple or bell)	<p>All birds should have unrestricted access to water.</p> <p>Recommended number of birds per nipple or round bell drinker should be adhered to throughout the rearing period within each pen.</p> <p>A minimum water-to-feed ratio of 1.6-2.0 liters of water to feed should be followed depending on house and external environmental temperatures.</p> <p>If pen sizes need to be adjusted for bird numbers, ensure bell and nipple drinker numbers are adjusted to maintain the correct number of birds per drinker.</p> <p>Ensure drinker heights are correct and adjusted for age.</p> <p>Ensure drinker flow rates and nipple type are correct for the age and requirements of the bird.</p>	<p>Drinker Table - Table 9, page 33.</p> <p>Section 1, page 35. Drinker Management</p>
Ventilation	Calculated for body weight and stocking density	<p>Ensure uniform air flow through all pens by using equal number of inlets open per pen and uniform distribution of inlets throughout house.</p> <p>Use correct number of fans for appropriate air volume calculated for biomass in house and pens.</p>	<p>Ventilation Rates Table - Table 25, page 113.</p> <p>Environmental Requirements</p>

Section 2: Management into Lay (15 Weeks to Peak Production)

From 105 Days (15 Weeks) to Light Stimulation

Objective

To ensure a healthy, stable development into maturity with minimal variation in the onset of sexual maturity of the flock and to prepare the flock for reproduction.

Principles

Targeted body-weight gains and uniformity during this period will ensure a smooth and successful transition to sexual maturity and egg production in the females, and will support uniform and optimum physical condition and fertility in males.

Management Considerations

For the management of young birds through to adulthood, achieving the correct stocking density and feeding and drinker space as birds reach sexual maturity is key to their individual development and the development of the flock. It will assist uniformity within the flock, reduce variation in sexual maturity (both within and between males and females) and help to maintain optimum physical condition and reproductive fitness of the flock. After 140 days (20 weeks) of age, feeding and drinker space should be increased to account for increased bird size and additional equipment (such as nest boxes) in the house during lay.

Stocking Density

Stocking density influences biological output. Recommended stocking densities from 15 weeks of age to depletion are given below (**Table 14**). The figures given are a guide; actual stocking densities may vary from those recommended depending on:

Welfare regulations.

Economics.

Environment.

Actual available floor space, drinker and feeder space.

Environment (ventilation) and management conditions (feeding and drinker space) must be appropriate for the stocking density to ensure optimal performance. Maximum stocking densities should not be exceeded.

Table 14
Recommended stocking densities from 15 weeks of age to depletion.

	Stocking Density Birds/m ² (ft ² /bird)	
	15-20 weeks	20 weeks to depletion
Male	3-4 (2.7-3.6)	3.5-5.5 (2.0-3.1)
Female	4-8 (1.3-2.7)	

Feeder and Drinker Space

Recommended feeder and drinker spaces for both males and females are given in **Table 15**.

Table 15
Recommended feeder and drinker space from 15 weeks of age to depletion.

	Age	Feeder		Drinker		
		Track cm (in)	Pan cm (in)	Bell cm (in)	Nipple	Cup
Male	15-20 weeks	15 (6)	11 (4)	1.5 (0.6)	8-12 birds/nipple	20-30 birds/cup
	20 weeks to depletion	20 (8)	13 (5)	2.5 (1.0)	6-10 birds/nipple	15-20 birds/cup
Female	15-20 weeks	15 (6)	10 (4)	1.5 (0.6)	8-12 birds/nipple	20-30 birds/cup
	20 weeks to depletion	15 (6)	10 (4)	2.5 (1.0)	6-10 birds/nipple	15-20 birds/cup

✓ KEY POINTS

Follow recommended allowances for stocking density and for feeding and drinker spaces, and adapt ventilation accordingly.

Ensure increases in available floor space and feeding and drinking spaces are given at the recommended ages.

Target Weight

Management focus during the period from 15 weeks (105 days) of age to light stimulation is the same for both males and females. The aim is to maintain a uniform flock of birds that follow the target body-weight and fleshing profiles so that the transition to sexual maturity occurs smoothly, uniformly and at the desired age. This is done by following the recommended increases in weekly energy intake and body weight.

Regular monitoring and recording of body weight and uniformity are vital management tools during this period. Development of secondary sexual characteristics, such as increased pin bone spacing in females and increased facial color in both sexes, is a good indicator of flock progress in sexual development.

Failure to meet required weekly incremental gains in body weight between 15 weeks of age and light stimulation is a common cause of poor performance, leading to:

Delayed onset of lay.

Reduced initial egg weight.

Increase in hen loss due to prolapse.

Increased number of infertile eggs.

Reluctance to mate due to slow onset of sexual maturity.

Loss of uniformity of body weight and sexual maturity.

Reduced peak production.

Loss of sexual synchronization between males and females.

Where average body weight is under target (defined as body weight being more than 100 g [0.22 lb] below target weight) at 105 days (15 weeks) of age, the body-weight curve should be redrawn and the birds gradually brought back to target body weight (by giving appropriate increases in feed) by the time of light stimulation (**Figure 37**). It is important to monitor body weight at 4, 9 and 15 weeks, constantly readjusting the profile to ensure frame development and uniformity are optimized before this stage.

Flocks that are over-fed and exceed target body weights between 15 weeks of age and light stimulation will commonly exhibit:

Early onset of lay.
Increased incidence of double yolks.
Reduced hatching egg yield.
Increased feed requirement through lay.
Reduced peak, persistency and total eggs.
Reduced male and female fertility throughout life.
Increased incidence of peritonitis and prolapse.
Loss of sexual synchronization between males and females.

Where average body weight is over target (100 g [0.22 lb] or more above target weight) at 105 days (15 weeks), the body-weight curve should be redrawn parallel to target (**Figure 37**). Note that birds must not be brought back to target if they are overweight at this stage; this will result in a loss of condition, which will have a negative impact on egg production.

Once birds are overweight, it is a matter of managing the flock closely to minimize the negative effect on production and uniformity. For underweight birds, it is possible to increase feed levels and weight gain. Ideally, neither situation should occur, and close monitoring is key to effective management.

✓ KEY POINTS

- Ensure flock body weight follows the target profile.
- Maximize uniformity of body weight and sexual maturity.
- Redraw target body weight if necessary (if the flock is under- or overweight at 15 weeks/105 days).
 - Underweight birds should be grown to reach target by light stimulation.
 - Have a new target parallel to the original target drawn for overweight birds.

Figure 37
Redrawing of body-weight profiles if females are under or over target weight (light or heavy) at 15 weeks (105 days) of age.

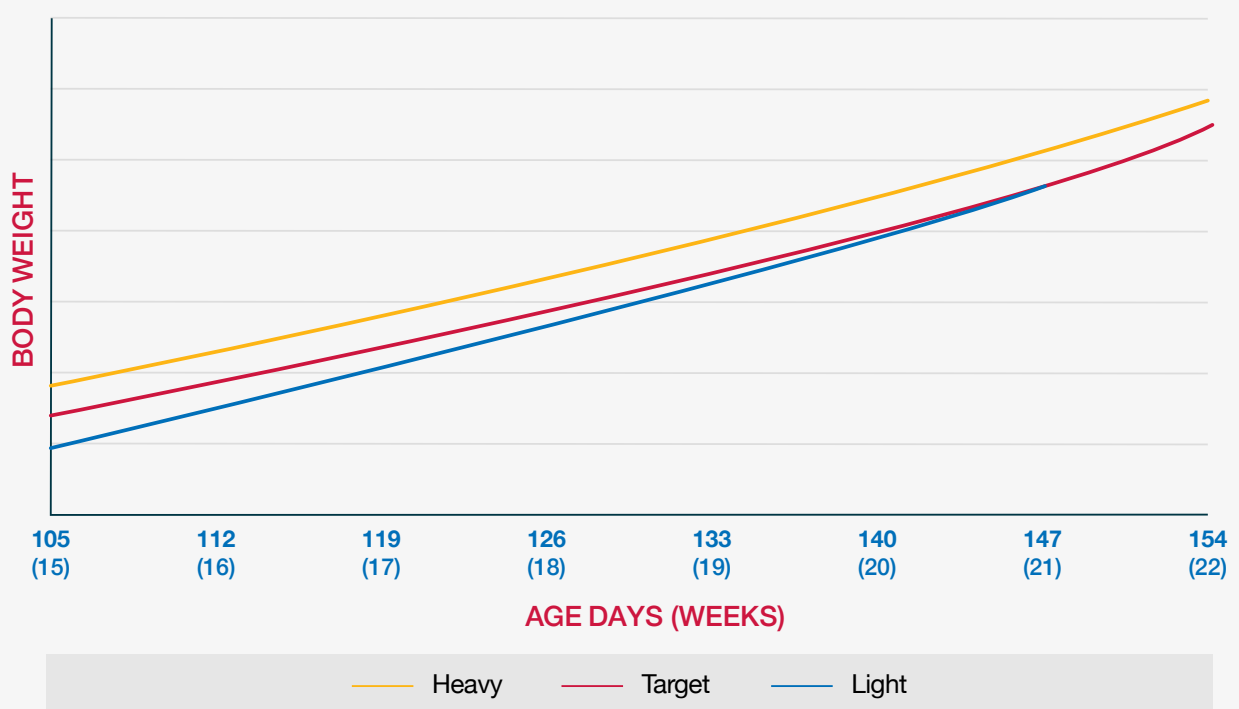

Feed Type and Energy Level

Inadequate nutrient supply as birds reach sexual maturity is a frequent cause of loss of uniformity. Careful management is required when feed type is changed (e.g., from grower to pre-breeder) and the flock manager should be aware of any changes in energy and available nutrient content between feed types or formulas. When a change in feed type occurs, feed provision must be altered accordingly; if energy content of the feed is reduced with a change in feed type, feed provision will need to be increased and vice versa.

✓ KEY POINTS

Be aware of any changes in energy or available nutrient content between feed types and formulas, and alter feed provision accordingly to account for this.

Lighting

In the period from 15 weeks of age to light stimulation, it is important that a constant 8 hours of light and a constant level of light intensity are maintained so that birds can respond appropriately to the light stimulation when it occurs (see section on *Lighting*).

✓ KEY POINTS

Follow recommended lighting programs.

Rear and Move Facilities

It is common practice to move birds from rearing facilities to separate laying facilities. The age at which transfer to the laying facilities occurs can vary depending on housing type. For light-proof laying facilities, transfer should not occur later than 21 weeks (147 days) of age. For open-sided laying facilities, transfer may need to be later than 21 weeks, depending on season and natural daylength, but should never occur after 23 weeks (161 days) of age. Regardless of what type of housing is used, transfer should not be completed before 18 weeks (126 days). It is recommended that males are moved before females (at least 1 day before) to allow them to find the feeders and drinkers. Females should be transferred to where their feeders and drinkers are located (**Figure 38**). Environmental and equipment differences must be minimized between rearing and laying facilities. It is important that feeding space is not reduced and that lighting programs and biosecurity are synchronized between rearing and laying houses.

Prior to transfer, rearing information such as numbers of birds, equipment density, water consumption, clean-up time, lighting program length and intensity, CV%, average weight and feed rates should be sent to the laying facility.

Figure 38
Transfer of birds onto the slats.



An additional increase in feed quantity (up to 50% more) on the day before and the day of transfer will help compensate for the challenges of moving. Birds should not be fed on the morning they are due to be moved. It is good practice for feeders in the laying facility to be fully charged to minimize the noise and bird disturbance caused by the equipment. Feed levels should be returned to normal on the first, or possibly second, day after transfer. The exact amount of extra feed given and the length of time over which it is given after transfer will depend on season, environmental temperature and transport duration.

After transfer, check crop fill of both males and females (**Figure 39**) to ensure they are finding feed and water. Crop fill should be assessed 30 minutes after the first feed on the day of transfer, and then again after the second day of feeding. A random sample of at least 50 females and 50 males should be assessed. If crop fill is found to be inadequate (ideally all birds assessed should have a full crop), the reason for this should be investigated and resolved (possibilities include: inadequate feeder space, feed distribution or availability of feed).

Figure 39
Crop fill assessment of broiler breeders after transfer. The bird on the left has an empty crop and the bird on the right has a full crop.



OTHER USEFUL INFORMATION AVAILABLE



*Best Practice in the Breeder House:
Transfer (Rear and Move)*

KEY POINTS

Provide extra feed on the day before and the day of transfer.

Ensure that males and females are finding feed and water and have adapted to separate sex feeding systems after transfer by monitoring feeding behavior and checking crop fill.

Minimize environmental and equipment differences between rearing and laying facilities.

Day-Old-to-Depletion Facilities

In day-old-to-depletion facilities, if the feeding system is changed between rear and lay, transferring birds to the new feeding system must be managed carefully. New feeders must be introduced so that birds are able to access them and find feed easily. For example, where birds are floor-fed in rear and then transferred to track feeders in lay, the track feeders should initially be set at a low height (low enough to allow the birds to see feed within the feeder) for the first 1-2 days. Check crop fill to determine that all birds have found the new feeders and are managing to access feed.

KEY POINTS

If there is a change in feeding system between rear and lay, manage this transfer carefully by ensuring that birds can easily find and gain access to the new feeders.

Mixing Males and Females

At the time of mixing males and females, additional management techniques are needed. If the males and females mix properly, it will benefit flock production and welfare during the entire production period. Therefore, pay attention to mating-up procedures, identification of sexing errors, management of separate-sex feeding and male-to-female ratio.

Mating-up

Mating-up should only occur when males and females are sexually synchronized and not before 18 weeks (126 days); an immature male should never be mated with a mature female. A sexually mature male will have a comb and wattles which are well-developed and red in color (**Figure 40**). A sexually mature female will also have a bright red comb and wattles (**Figure 41**). Mating-up should be postponed by 7 to 14 days if sexual maturity is delayed or the birds are to be moved from dark-out rearing to open-sided laying facilities. This postponement will give the birds more time to become sexually mature and give better control over feeding (as males will be bigger, the separate-sex feeding systems will work better).

Figure 40
An example of a mature young male with a well-developed comb and wattles that are red in color (on the left) and an immature male with an under-developed comb and wattles that are pale in color (on the right).



Figure 41
An example of a young female with a well-developed comb and wattles that are red in color (on the left) and an immature female with an under-developed comb and wattles (on the right).



If the facility has separate male pens, and variation exists in sexual maturity within the male population and some males are visibly immature, the more mature males should be mixed with the females first. As an example, if the planned mating ratio is 9.5 to 10%, then a possible system of mating-up would be to mix 50% of the total number of required males (those that are most mature) at 21 weeks, mix a further 25% (again the most mature males) a week later, and then finally mix the remaining males the following week.

If males are more mature than females, they should be introduced to the females more gradually. For example, mate-up at a ratio of 1 male for every 20 females, then gradually add more males over the next 14 to 21 days to reach the desired mating ratio. During the process of mating, the male takes hold of the female's comb and side steps onto the female (**Figure 42**).

In the period from mating-up until all males have become sufficiently large enough to be physically excluded from the female feeders (approximately 26 weeks of age), feeding behavior should be carefully monitored (at least twice a week). This is necessary to check that the separate-sex feeding systems are working properly and that feed is being distributed correctly and evenly.



KEY POINTS

Ensure both males and females are sexually mature at mating-up.

Make sure immature males are not mated to mature females.

Mating up should not occur before 18 weeks (126 days).

Monitor feeding behavior.









Figure 42
Mating male and females



Sexing errors

Identifying sexing errors (males present in female pens and females present in male pens) can be difficult at early ages, but it is good practice to remove these birds whenever they are identified during the life of the flock. Ideally, all sexing errors should be removed before mating-up. The criteria for doing this are illustrated in **Figure 43**.

Figure 43
Criteria for identifying males and females for the resolution of sexing errors.

Male		Female
	<p>Comb and Wattles 105 days (15 weeks) More developed and redder in males.</p>	
	<p>Hock Joints 140 days (20 weeks) Thicker and broader in males. Narrower and smoother in females</p>	
	<p>Feathering Around the Neck 140 days (20 weeks) Long-fringed, spear-shaped feathers in males. Denser, paddle-shaped feathers in females.</p>	
	<p>Body Shape 140 days (20 weeks) Males longer and narrower. Females more compact and broader around pelvis.</p>	

Separate-Sex Feeding Equipment

After transfer, males and females should be fed from separate feeding systems (**Figure 44**).

Separate-sex feeding takes advantage of differences in head size between males and females and allows more effective control of body weight and uniformity in each sex. Separate-sex feeding requires especially careful management, and feeding behavior should be monitored regularly throughout lay. At a minimum, feeding behavior of both sexes should be **monitored daily** up to 26 weeks of age.

Complete exclusion of all males from the female feeders normally occurs around 26 weeks of age. Up to this point some males may still be able to access the female feeding system and steal female feed. Females should also be excluded from male feeders. Careful monitoring of body weight and feeding behavior is important at this time to ensure that both males and females are receiving enough feed to maintain target increases in body weight. After 26 weeks of age, monitoring of feeding behavior can be reduced to once a week.

Feeding equipment must be properly adjusted and maintained; poorly managed and badly maintained feeding equipment gives uneven feed distribution, which is a major cause of depressed egg production and fertility.

Female Feeding Equipment

With track feeding systems, the most effective method of preventing male access to the female feeders is to fit grills (grids or toast racks) to the tracks (**Figure 44**). Males are then excluded from the female feeders because of their greater head width and comb height, while female access remains unrestricted. Internal grill width should be 45-47 mm (1.8-1.9 in) and grill height should be 60-70 mm (2.4-2.8 in). The addition of horizontal wires on either side of the apex of the grid will help to strengthen the grill. Grid widths less than 45 mm (1.8 in) will prevent a significant number of the females from feeding and cause reduced performance.

The addition of a plastic pipe in the apex of the grill can be used to further restrict male access (**Figure 45**). This addition is particularly useful from the time of mating-up until physical maturity (approximately 30 weeks of age). After about 33-35 weeks of age, the pipe can be removed. It is important to make sure that the piping is fixed correctly and securely to the apex of the feeder. If not, the piping may sag and restrict female access to the feeder.

Figure 44
Separate-sex female feeding system showing grills (grids or toast racks).

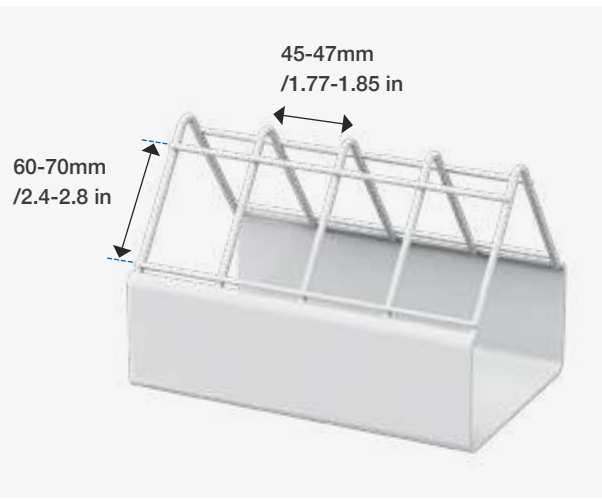

Figure 45
Separate-sex feeding system for females showing grills and the addition of plastic pipe in the apex.



An alternative to grills is roller bars (**Figure 46**). These are fitted to the track feeding system and the height is adjusted as the birds age. Bar height should start at 43 mm (1.7 in) at mating-up and gradually be increased to 47 mm (1.9 in) by 30 weeks of age.

A grill can also be used to prevent access by males to automatic pan feeders or hanging hoppers (tube feeders). With hanging hoppers (tube feeders), feeder movement should be reduced to a minimum.

Daily checks should be made for feed spillage, as well as damage, displacement or irregularity of gaps in the female feeder system. Failure to detect and correct such problems will allow males to steal female feed (**Figure 47**), and effective control over body weight and uniformity will be lost.

Male Feeding Equipment

Three types of feeders are generally used for males (**Figure 48**):

Automatic pan-type feeders.

Hanging hoppers (tube feeders).

Suspended feeder track.

Hanging hoppers (tube feeders) and suspended feed tracks are both suspended from the house roof, and feeder height can be adjusted appropriately for the male population. When hanging hoppers are filled manually, it is important that the same feed quantity is delivered to each hopper and that the hoppers are not tilted to one side. Counterweights beneath hanging hoppers are useful to reduce movement.

Figure 46
A roller bar system used to restrict male access.



Figure 47
Males stealing from female feeders.



Figure 48
Male feeders (from left to right: automatic pan feeders, hanging hoppers, suspended feeder track).



Suspended feeder tracks for males have proven successful because feed can be levelled or evened out within the track, ensuring an even feed distribution.

After feeding and where possible, suspended feeders should be raised to deny males further access to the feeders. When feeders are raised, the next day's allocation of feed should be added so that when they are lowered at the next feeding time, males have instant access to feed. It is beneficial to delay male feeding until about 5 minutes after the female feeders have been filled.

It is essential that male feeder height is correctly adjusted so that all males have equal access to feed at the same time, while female access to the feeders is prevented (**Figure 49**). Correct male feeder height is dependent on male size and feeder design, but as a general rule, male feeder height should be in the range of 50-60 cm (20-24 in) above the litter. Care should be taken to ensure that the litter under the feeders is level and any build-up of litter beneath male feeders should be avoided as this will reduce feeder height, allowing females to steal male feed. Daily observation and adjustment at feeding time are necessary to ensure that male feeder height remains correct.

As male numbers decline, the number of male feeders should also be reduced to ensure that feeding space remains optimal. Care should be taken to avoid giving too much feeding space to males, as the more aggressive males will over-consume, male body-weight uniformity will decline, and a loss in reproductive performance will occur.

Restaurant feeding

During the rearing period, males are trained to recognize a signal, such as a whistle, to attract them to the feeders. During production, this means that females are fed first, and then males receive the signal to move to the male feeding area, which is separate from the females. The males are fed and remain in the male feeding area for 1-2 hours before being released into the female population.

This system allows for robust feed management, body weight and body condition control. Due to complete separation from the females, male feeder height can be reduced to encourage uniform feed uptake for all males, promoting uniformity of male body condition.

Figure 49
Correct male feeder height.



✓ KEY POINTS

Distribute feed with the lights off.

Provide separate male and female feeding systems. Female feeding systems should be designed to prevent male access and male feeders managed to exclude females.

Observe feeding behavior daily for: separate-sex feeding, number of males excluded from female feeders, correct male feeder height, adequate feeding space and feed distribution.

Daily checks of female feeding system for signs of feed spillage, damage, displacement or gaps that might allow male access.

Management of Females Post Light Stimulation until 5% Production

Objective

To bring the female into lay by stimulating and supporting egg production using feed and light.

Principles

Females need to be grown to the target body-weight profile and with the recommended lighting program (see section on *Lighting*) so that the flock comes into production in a uniform way.

Management Considerations

For equipment, stocking density, and feeder and drinker space recommendations, see **Table 14** and **Table 15** (see section on *15 Weeks to Peak Production*).

Regular feed increases (at least weekly) are essential for appropriate body-weight gain, uniform sexual maturity, fleshing and timely onset of lay. Lighting programs should be implemented on schedule to support and stimulate females during this period.

The first light increase should be given when birds are sexually mature at, or greater than 147 days (21 weeks) of age, but the exact timing will depend primarily on body weight, body condition and flock uniformity. If the flock is uneven (CV% greater than 8, uniformity less than 79%), light stimulation should be delayed by approximately 1 week (see section on *Lighting*). However, if the flock is not uniform, the birds that are not ready will have a delayed onset of egg production, while matured birds may start laying eggs before light stimulation. This will cause disruption in the performance leading to difficulties in feed increase decisions.

The spacing of the birds' pin (pubic or pelvic) bones should be measured to determine the state of sexual development of the female. When measuring pin-bone spacing, it is also a good idea to check the amount of abdominal fat covering the pin bones. For further information on monitoring pin bone spacing, refer to the section on *Assessment of Bird Physical Condition*.

Water should be freely available. For more information on water and drinker management, please see *Drinker Management*.

The breeder 1 feed should be introduced from 5% hen-day production at the latest to ensure that the birds receive the correct volume and balance of nutrients (such as calcium) to support egg production.

Any problems with feed, water or disease at this stage can have devastating effects on the onset of lay and subsequent flock performance. It is, therefore, wise to monitor and record uniformity, body weight and feed clean-up time, responding quickly to any decrease in uniformity, any change in feed clean-up time, or any reduction in body-weight gain.

Nest boxes should be opened just before the anticipated arrival of the first egg (likely 10-14 days after the first light increase is given). Opening nest boxes too early will reduce the females' interest. Dummy eggs can be placed in nests to encourage the birds to lay in them. Where automated systems are used, the egg collection belts should be run several times each day, even before the arrival of the first egg, so that the birds become accustomed to the sound and vibration of the equipment.

✓ KEY POINTS

Achieve target body-weight by concentrating on correct weekly incremental feed increases and resultant bird gains.

Follow the recommended lighting program.

Monitor flock uniformity, body weight and feed clean-up time, and respond quickly to any issues.

Provide unlimited access to clean, good-quality water.

Change from grower to breeder 1 feed by 5% production at the latest.

Open nest boxes just before anticipated arrival of first egg.

Measure and record pin-bone spacing.

Floor Eggs

Floor eggs represent a loss in production and a hygiene risk to the hatchery. Appropriate training of birds to lay eggs in the nests will reduce floor eggs. Below are a number of best practices that can reduce the occurrence of floor eggs (Figure 50):

Slat height should be a maximum of 25-30 cm (10-12 in).

Ensure litter depth is correct.

Allow access to perches from 28 days (4 weeks).

Incorporate a suitable alighting/perching rail in nest box design.

Ensure male and female sexual maturity is synchronized.

Have uniform distribution of light of between 30 and 60 lux (3-6 fc). Avoid the presence of dark and shaded areas next to walls, corners, and in the areas next to steps and slat fronts. If floor eggs are a particular problem, light intensity may need to be increased above recommended levels.

Provide correct feeder space for females.

Follow the recommended lighting program and ensure that light stimulation is synchronized with body weight.

Where automated systems are used, run the egg-gathering belts several times each day.

Keep nest boxes closed until just prior to the anticipated arrival of the first egg (Figure 51).

Walk around the house as frequently as possible (at least 6 and up to 12 times a day), picking up any floor eggs. This will prevent floor eggs being laid habitually.

Gently pick up birds attempting to nest on the floor and place them into a nest.

Set feeder and drinker heights appropriately so that they are not obstacles to nest access.

Manage mating ratios to avoid over-mating.

With manual nests, put 20% of nests at floor level to start. Thereafter, gradually raise them (over a period of 3 to 4 weeks) to the normal height.

Allow 3.5-4 hens per nest hole for manual nests.

Allow 40 hens per linear meter (12 birds per linear foot) for mechanical (communal type) nests.

Ensure environmental conditions are adequate and avoid drafts in the nesting places.

Set feeding times to avoid the peak of egg laying activity. Feeding time should be either within 30 minutes of "lights on" or 5-6 hours after "lights on" to prevent birds from feeding when most eggs are likely to be laid.

Figure 50

Example of floor eggs being laid outside the nest.



Figure 51

Example of closed nest boxes. Nest boxes will be opened just prior to the anticipated arrival of the first egg.



KEY POINTS

Attention to detail avoids floor eggs.



OTHER USEFUL INFORMATION AVAILABLE



*Best Practice in the Breeder House:
Preventing Floor Eggs*

Nest Box Set-up

Nest boxes must be set up prior to the onset of lay. The entrance to the nest must be large enough for the hen to enter, turn around and exit comfortably (**Figure 52**). Nests must have a firm entrance and a solid base and be securely fixed in place.

For manual nest boxes, the lower alighting rail should be no more than 55 cm (22 in) from the floor, and it should extend to a minimum of 10 cm (4 in) beyond the rail of the second tier (**Figure 53**).

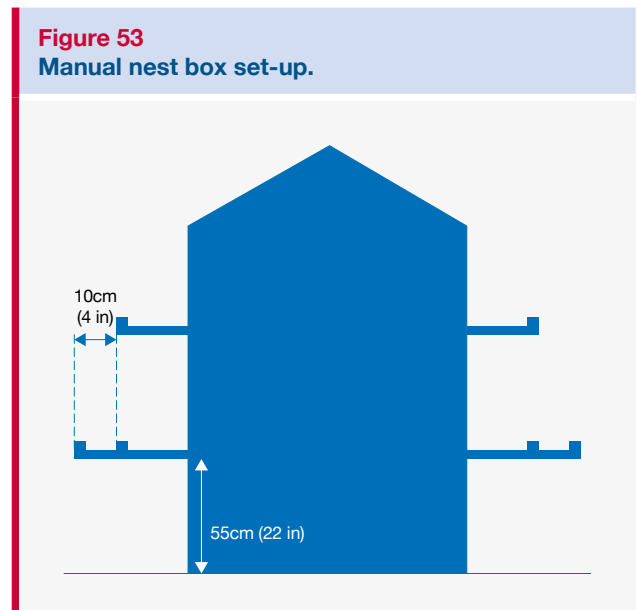
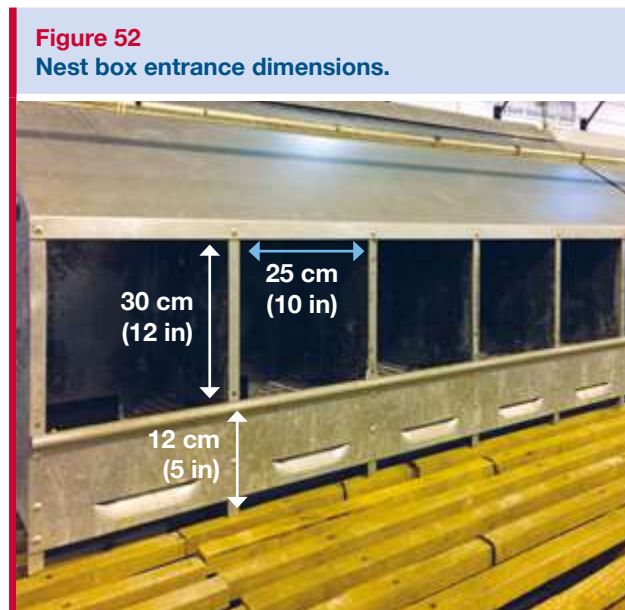

Routine Management of Automatic and Manual Nests.

Eggs laid in a good nesting environment are less susceptible to bacterial contamination, cracks and other factors that could reduce hatching egg quality. Best practice management of manual and automatic includes attention to details, such as:

Automatic and manual nests should be visually monitored for cleanliness daily. Any fecal or organic material should be removed from the nests by simply scraping or brushing it away by hand, cloth or brush.

Automatic nests should be checked before the first egg collection for any remaining eggs within the nests, or obstructions to the belt that may result in the accumulation or damage of eggs on the belt.

Egg collection frequency should be adequate to prevent belts from becoming full and to minimize the number of cracked and dirty eggs. After the final egg collection each day, all hens in manual nests should be removed to prevent territorial or “broody” behavior.

Automatic egg belts should be cleaned or sanitized weekly, and nest mats should be removed and cleaned or sanitized at least every 6 weeks. Water and approved sanitizers can be used for cleaning, but always follow manufacturer’s instructions for mixing and/or dilution, as well as local legislation. Have a second set of nesting mats available as part of a regular rotation, and discard worn or structurally compromised mats. Based on daily observations, a routine schedule should be in place for replenishing or “topping off” the nesting material within manual nest boxes.



OTHER USEFUL INFORMATION AVAILABLE



*How To: Manage Manual and Automatic
Nests and Nest boxes*

Management of Females from 5% Hen-day Production until Peak Egg Production

Objective

To promote and support female reproductive performance throughout the laying cycle.

Principles

Hatching egg production performance from onset of lay to peak production is affected by early egg size, egg quality and level of peak production. Correct body weight during early lay can be achieved by providing females with feed levels that will meet the increased demands of egg production and growth.

Management Considerations

For equipment, stocking density, and feeder and drinker space recommendations, see **Table 14** and **Table 15** (See section *15 Weeks to Light Stimulation*).

Females must continue to gain weight during early lay to maximize egg production and hatchability. Birds should be fed to meet the increased demands of egg production and growth, but overfeeding must be avoided. Birds that receive more feed than required for maintenance, growth and egg production will not develop an optimal ovarian structure and will gain excess weight - resulting in poor quality eggs, low hatchability and increased risk of peritonitis and prolapse.

The difference in feed quantity allocated prior to first egg and the target feed level given at peak (see the Ross Parent Stock Performance Objectives for more details) allow a feed allocation schedule to be established. Amount of feed given up to and at peak should then be adjusted for each individual flock depending on:

- Hen-day production.
- Daily egg weight and change in egg weight trend.
- Body weight and body-weight gain trend.
- Feed clean-up time.
- Dietary energy density.
- Operational environmental temperature.
- Degree of body fleshing and fatness.

Responsive management of birds coming into production requires frequent observation and measurement of the production parameters listed above. These parameters are not used in isolation, but rather in combination, to determine whether or not the feed allocation for an individual flock is correct. Both the absolute and trend data should be taken into account.

For example, if there is an unexpected change or deviation from target in hen-day production, egg weight, body weight or feed clean-up time, then feed allocation should be reviewed. However, in order for the flock manager to make informed decisions on feed quantity, dietary energy content and environment temperature must also be known. The frequency with which each of these parameters should be measured is given in **Table 16**. Monitoring of body weight, daily egg production and daily egg weight is key when determining feed allocations.

Table 16
Frequency of observation of important production parameters.

Parameter	Frequency
Egg production	Daily
Increase in egg production	Daily
Egg weight	Daily
Body weight	Weekly (manual) / Daily (automatic)
Body-weight gain	Weekly (manual) / Daily (automatic)
Feed clean-up time	Daily
House temperature (min. and max.)	Daily
Body condition and fleshing	Weekly (and on walk-through)

Feed increases given should be proportional to actual rates of production. Thus, in high-producing flocks, extra feed may need to be given, and feed increases beyond recommended peak feed amounts may be justified. Equally, if egg weight and/or body weight are judged to be markedly below the expected target, then feed increases should be advanced. Small but frequent feed increases to peak feeding levels should be used to prevent excessive weight gain. Management requirements for each flock will vary depending on body condition, reproductive performance, environment, equipment and facilities. An example of how a feeding program can be devised for a particular flock, taking into account flock history, type of housing, feed composition and management constraints, is discussed on the next page.

✓ KEY POINTS

- Monitor and achieve target body weight and body-weight gains.
- Monitor daily egg production and egg weight.
- Stimulate egg numbers from 5% production by giving programmed increases in feed allocation.
- Follow the recommended lighting programs.
- Define the program of feed increases based on feed amount prior to production, dietary energy level, ambient temperature and expected flock productivity.
- Use small but frequent feed increases.

✓ KEY POINTS

- Monitor feed clean-up times and trends in feed clean-up times and respond to any changes in feed consumption trends.

Feed Clean-up Trends

Feed clean-up time is a useful monitoring practice for ensuring that the flock is getting adequate energy intake. Clean-up time is the time it takes for the flock to eat its daily feed allocation (from when the feeder starts to operate until there is only dust left in the feeder). When the amount of feed being offered is excessive, birds will take longer to consume it. Conversely, when there is not enough feed, birds will consume it more quickly than expected. Many factors affect clean-up time, including age, temperature, feed amount, physical feed characteristics, feed nutrient density and composition and ingredient quality. Therefore, trends (changes) in feed clean-up time are as important as absolute time taken to clean up feed. Monitor and record feed clean-up time trends. If there is a change in clean-up time, possible causes (energy levels not as expected, poor feed quality, health issues and incorrect feeding volumes) should be investigated.

At peak production, feed clean-up time is normally in the range of 2-4 hours at 19-21°C (66-70°F) dependent on feed physical form (**Table 17**).

Table 17
A guide to feed clean-up times at peak production.

Feed Clean-up Time at Peak Production (hours)	Feed Texture
3-4	Coarse Mash
2-3	Crumble
1-2	Pellet

Egg Weight and Feed Control

Trends in daily egg weight act as a sensitive indicator of the adequacy of total nutrient intake; inadequate nutrient intake will lead to a fall in egg weight, and excessive nutrient intake will lead to an increase in egg weight. Feed intake should be adjusted according to deviations from the expected daily egg weight profile over a 3-4 day period.

Daily egg weight should be recorded from 10% hen-day production onwards. A sample of 120-150 hatching eggs should be bulk weighed (**Figure 54**) daily. The sample eggs should be taken from eggs collected directly from the nest at second collection to avoid using eggs laid the previous day. Double-yolked, small and abnormal eggs (e.g., soft shelled) should be rejected and not be weighed.

Figure 54
Bulk weighing of eggs.

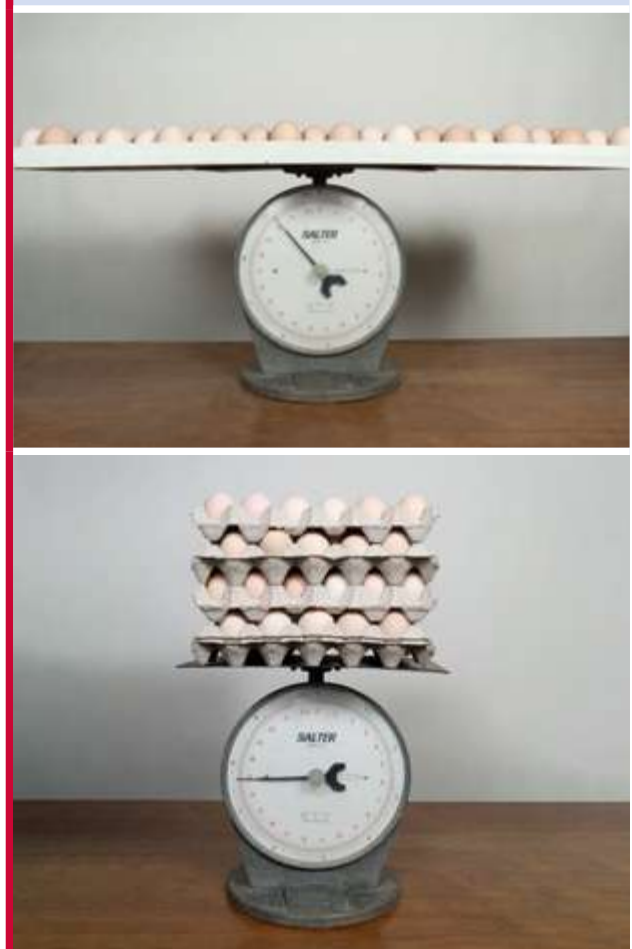

Average daily egg weight is obtained by dividing the bulk weight (weight of eggs minus weight of tray or trays) by the number of eggs weighed. The daily egg weight should then be plotted against target; it is important that the graph scale is large enough to make daily variation clearly visible. In flocks receiving the correct quantity of feed, egg weight will usually follow the target profile. However, it is normal for average egg weight to fluctuate on a daily basis due to sampling variation and environmental influences (**Figure 55**).

If the flock is being under-fed, egg size will not increase over a 3-4 day period, and egg weight will deviate from target (**Figure 56**). If peak feed amount has not been reached, the next planned feed increase should be brought forward to correct this. If peak feed has been reached then an additional increase in peak feed amount will be required (3 to 5 g [0.1 to 0.2 oz] per bird).

Figure 55
An example showing normal fluctuations in the daily weight of bulk-weighed eggs.

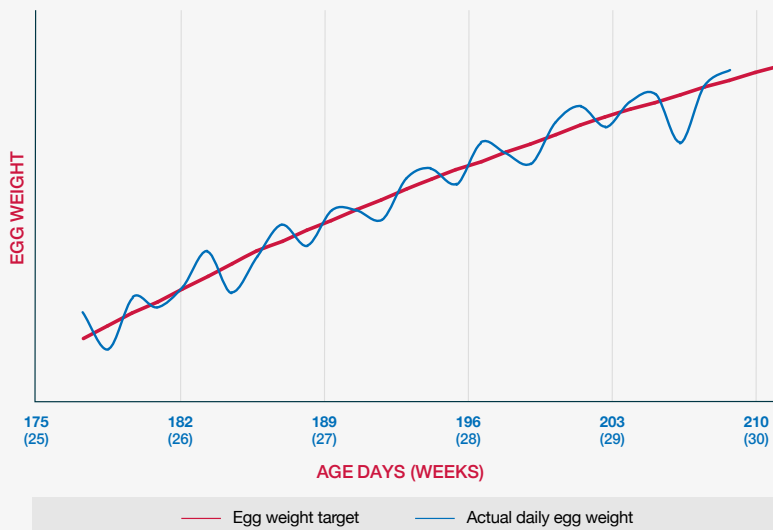

KEY POINTS

Bulk weigh samples of eggs and record average daily egg weight from 10% hen-day production.

Weigh eggs from the second collection to avoid using eggs from the previous day.

Monitor daily egg weight trends by plotting against target.

Respond promptly to falling daily egg weight trends by increasing feed allowance.

OTHER USEFUL INFORMATION AVAILABLE



*Broiler Breeder
Management How
To: Weigh Eggs*

Figure 56
Example of reduction in average daily egg weight over a 3 to 4 day period due to inadequate feed intake.

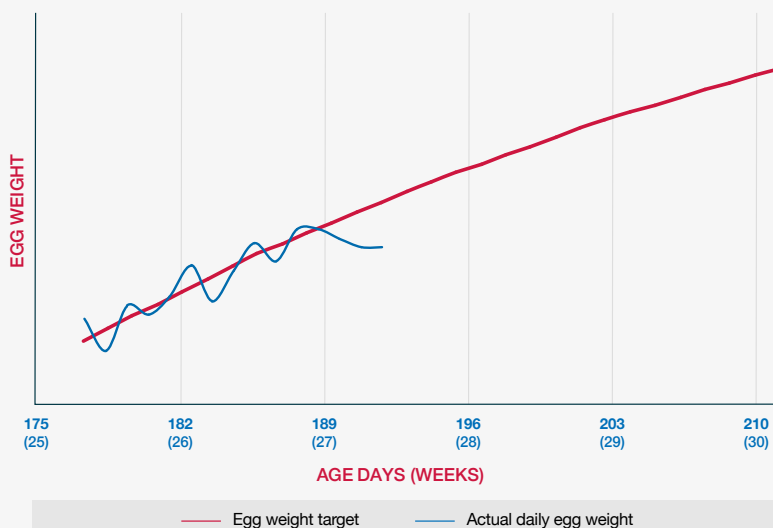

Management of Males Post Light Stimulation Until Peak Egg Production

Objective

To optimize fertility and ensure persistency of flock fertility.

Principles

Females require the correct number of males that are in optimal physical condition.

Feeding Considerations

Control of male body weight and condition during the period between light stimulation and peak can be difficult, as males become progressively excluded from the female feeders. Body condition, average body weight and body-weight gains should be monitored ideally twice a week during this period to ensure that the males remain in optimal physical condition and that body weight remains on target (see the **Ross Parent Stock Performance Objectives** for more details). Preventing males from becoming over- or underweight is only possible when separate-sex feeding systems are well maintained and managed.

Typically, males become excluded from female feeders from about 22 weeks of age but some males may continue to access the female feeders up until around 26 weeks of age. Frequent visits by personnel at feeding time to observe feeding behavior are essential at this time. Failure to detect when the males are excluded from the female feeders is a common cause of low male body weight and poor physical condition in the pre-peak period and has serious implications for early and late fertility.

Males stealing female feed, particularly when the flock is between 50% hen-day egg production and peak, may lead to males becoming overweight and the females becoming underweight with a consequential marked reduction in peak egg production levels. Monitoring female factors such as daily egg weight and body weight will indicate if this problem is occurring. If males are stealing female feed, there will be a shortfall in average daily egg weight trends and female body weight, and then, subsequently, egg production will drop. Refer to the previous section on male feeding for solutions to minimize males stealing female feed.

Underfeeding

Underfeeding of males can occur during the early stages of production after mixing of males and females. This is because mating behavior at this stage is very active and so nutrient requirements are high. Males will become dull and listless, showing reduced activity and less frequent crowing if they are being underfed.

If these symptoms are missed and the condition progresses, the comb becomes loose and soft. There will be a loss of body weight and body condition, reduction in face and vent color, and eventually molting will occur. The last stage (molting) cannot be recovered from. On observing any combination of these symptoms, immediately check feed clean-up time, feeding space per bird and separate-sex feeding systems. Next, the accuracy of weekly average weight gain data should be verified and a sample of males (10% of the population) re-weighed. If inadequate body weight is verified, increase feed allowance by 3-5 g/bird/day (0.7-1.1 lb/100 birds/day) without delay. Prompt action is essential.

Overfeeding

Excessive feed consumption in males may occur due to oversupply (inaccurate weighing of feed), variation among males in intake or feeding from female feeders (inadequate measures to ensure male exclusion). If body weight control is poor, a sub-population of heavy males with excessive breast development may occur. Females will begin to avoid mating if a considerable percentage of males are overweight. Additionally, over-fleshed males may become impaired in their ability to successfully complete matings. This can lead to a deterioration in female feathering as males struggle to balance. Overweight males losing condition will be among the first to undergo testicular regression and associated reductions in mating activity and fertility will occur. Excessively overweight males (10% or more over target weight) should be carefully assessed and removed from the flock if they are not mating (see section on *Assessment of Bird Physical Condition*).



KEY POINTS

Grow males to the target body weight and physical condition and achieve target weekly body-weight gains.

Use separate-sex feeding with adequate, well-maintained equipment.

Observe feeding behavior daily.

Any shortfall or reduction in male body weight has serious implications for fertility.

Consider removing overweight males (10% or more over target weight) from the flock.

Mating Ratio

To maintain fertility throughout lay, each flock will require an optimum number of sexually active males. As the flock ages and egg production declines, fewer males are required to maintain fertility (**Table 18**), so substandard and non-working males can be progressively removed from the flock as it ages. The mating ratios given below are a guide only and should be adjusted according to local circumstances and flock condition. Higher ratios than those given in the table may be required in open-sided laying houses where mating activity may be lower due to high environmental temperatures.

Table 18
A guide to typical mating ratios as a flock ages.

Age		Number of Good Quality Males Per 100 Females
Days	Weeks	
154 - 168	22 - 24	9.50 - 10.00
168 - 210	24 - 30	8.50 - 9.50
210 - 245	30 - 35	8.00 - 8.50
245 - 280	35 - 40	7.50 - 8.00
280 - 350	40 - 50	7.00 - 7.50
350 to depletion	50 to depletion	6.50 - 7.00

Mating ratio should be reviewed weekly. Based on an assessment of physical condition and body weight, any males considered to be non-working should be removed from the flock in line with recommendations to achieve suggested mating ratios. Males retained for mating should have the following characteristics (see section on *Assessment of Bird Physical Condition* for more information):

- Uniformity in body weight.
- Freedom from physical abnormalities (alert and active).
- Correct beak shape.
- Strong, straight legs and toes.
- Well feathered.
- Good upright stance.
- Good muscle tone and body condition.
- Comb, wattles and vent showing evidence of mating activity.
- Red, moist vent.

The removal of non-working males from the flock should be a continuous process. Removing a large number of males at one time will lead to unnecessary disturbance.

Over-mating

A surplus of males leads to over-mating, interrupted mating and abnormal behavior. Over-mated flocks will exhibit reductions in fertility, hatchability and egg numbers. In the early stages, after mating-up, it is quite normal to observe some displacement and wear of the feathers at the back of the female's head and of the feathers on the back at the base of the tail. When this condition progresses to the removal of feathers, this is a sign of over-mating. If the mating ratio is not reduced, the condition will worsen, with de-feathering of areas of the back and skin scratches occurring. This may lead to low welfare, loss of female condition and reduced egg production. Excessive injuries and feather damage to the males as a result of fighting may also occur. Over-mated females who are non-receptive to males or mating may be seen hiding from the males beneath equipment or in nest boxes, or refusing to come down from the slatted area.

Surplus males must be removed quickly or a considerable loss in persistency of male fertility will result. The signs of over-mating generally become more obvious at around 182 to 189 days (26 to 27 weeks), becoming most apparent by 210 days (30 weeks), but the flock should be examined for signs of over-mating on a daily basis from 175 days (25 weeks) onwards. When over-mating occurs, the removal of males from the flock should be advanced with an additional one-off removal of males from the flock. An additional 1 male per 200 females should be removed and then the planned pattern of reduction (1 male per 200 females every 5 weeks - see **Table 18**) should continue to be followed.

✓ KEY POINTS

As the flock ages, fewer males may be required to maintain flock fertility. Having males of good quality is key.

Substandard and non-working males should be continuously removed as the flock ages.

Review mating ratios weekly.

Monitor females for signs of over-mating from 25 weeks of age.

Whenever over-mating occurs, surplus males must be removed as quickly as possible; inspect males and remove those that are not working.

Section 3: Management in Lay (Peak to Depletion)

Management of Females After Peak Production Through to Depletion

Objective

To maximize the number of fertile hatching eggs produced per female by ensuring persistency of egg production post-peak.

Principles

To maintain productive performance beyond peak production, females must gain body weight close to the recommended target. Failure to control body weight (and, thus, fat deposition) post-peak can significantly reduce persistency of lay, shell quality and female fertility and it can increase egg size after 40 weeks of age.

OTHER USEFUL INFORMATION AVAILABLE



Ross Note: Female Persistency Post-Peak - Managing Fertility and Production



Ross Note: Controlling Late Egg Weight in Broiler Breeders

Factors for Post-Peak Management

Post-peak females must gain body weight and maintain good body condition close to the recommended target. If body-weight gain is inadequate, total egg production will be reduced. If body-weight gain is too rapid, post-peak production persistency and fertility will be lowered.

Shortly after peak production, maximum nutrient requirements for egg production occur because egg mass continues to increase after there has been some reduction in rate of lay. Peak egg production is usually achieved around 217 days (31 weeks) and can be defined as no increase in daily hen-day production over a 5-day period. Shortly after peak production, at around 224 to 231 days (32 to 33 weeks), peak egg mass occurs.

$$\text{Egg Mass} = (\text{Average Egg Weight [g/oz]} \times \text{Hen-Week \%}) \div 100$$

From the time of peak production, growth should continue but at a slower weekly rate (see the **Ross Parent Stock Performance Objectives** for more information).

Birds should never lose weight. However, after peak feed has been given and peak egg production has occurred, relative feed reductions will be required in order to achieve the recommended target body weight and to limit rate of fat deposition, loss of feather and shell quality as egg production declines. Post-peak feed reductions should start when egg mass does not increase over a period of 5-7 days. Good persistency will be maintained by controlling body-weight gain to 20 g/female/week (0.7 oz/female/week) to manage egg weight gains and therefore egg mass.

Procedures

Many factors are involved in determining the exact timing of the initial feed reduction post-peak. Timing and amount of feed reduction may be affected by:

Body weight and body-weight change from the start of production.
Daily egg production and the hen-day production trend.
Daily egg weight and egg weight trend.
Egg mass trend.
Health status of the flock and feathering condition.
Ambient environmental temperature.
Feed energy and protein levels.
Feed texture.
Feed quantity consumed at peak (energy intake).
Flock history (rearing and pre-peak performance).
Changes in feed clean-up time.
Feather cover.

Due to variation between flocks in the characteristics given above, the program of feed reduction will vary for each flock. To enable the flock manager to monitor and establish an appropriate feed reduction program, it is critical that the following characteristics are measured, recorded and graphed onto a chart:

- **Daily (or weekly)** body weight and body-weight change relative to the target (see the **Ross Parent Stock Performance Objectives** for more details on target body weights). Accurate body-weight monitoring is critical during the post-peak period (see section on *Monitoring Broiler Breeder Growth*).
- **Daily** egg weight and egg weight change relative to the target.
- **Daily** changes in feed clean-up time. Clean-up time is the time between feeder switch-on and trough clearance; at peak these are normally 3-4 hours for mash, 2-3 hours for crumbles, 1-2 hours for pellets. If clean-up time is more or less than the times indicated, it suggests that feed levels may be too high or too low, respectively. Consideration should also be given to feed quality, particle size, bird health, environmental changes, and human or equipment errors.

In addition, the flock manager should routinely handle and examine the birds to ensure they are in good physical condition (see section on *Assessment of Bird Physical Condition* for more information).

General Guidelines for Post-Peak Feed Reductions Based on Target Performance Characteristics

Under moderate temperate conditions where performance levels are close to or on target and birds are fed the recommended nutrient levels, general guidelines for feed reductions after peak can be found in the **Ross Parent Stock Performance Objectives**. Birds must receive the correct amount of feed to adequately fulfill their changing requirements for growth, egg production and maintenance (**Figure 57**). However, the actual program of feed reduction should be based on the close and accurate monitoring of daily body weight, daily egg weight and feed clean-up time. Normally, good production is achieved when total feed allocation reduction is between 5-8% from peak feed to depletion (64 weeks). Aviagen studies have shown that feed reductions >8% may negatively affect performance.

Feed reductions are normally initiated around 5 to 6 weeks after peak production has occurred. However, if body-weight increases are above target between peak and 35 weeks of age (if there is a change in the direction of the growth curve), feed withdrawal may need to begin earlier than this.

There will be situations where flock performance differs markedly from the published performance targets and the feed reduction program will need to be altered accordingly to account for this. The following are examples of two specific field situations illustrating suggested feed reduction strategies where performance differs from published targets.

Flocks Performing Above Target Recommendations

Flocks performing above the published performance targets can be under-supplied in feed and thus, nutrients, and both body weight and egg weights may start to slow or fall off when compared to the expected incremental gain (**Figure 58**). Excessive feed reductions after peak can potentially have a negative impact on production and leave birds susceptible to molting and broodiness. When flocks are performing above target recommendations, feed reductions after peak should be less and more gradual; peak feed may need to be held for longer, onset of feed reduction delayed and less feed reduced overall from 245 days (35 weeks) to depletion.

Daily egg weight, body weight and condition, production and feed clean-up times should be monitored closely. In particular, recording and monitoring body weight and egg weight will indicate if feed reduction is being done correctly. Under normal conditions, gradual reductions in egg weight and then body weight are the first signs that feeding is not correct, and will precede a drop in production. In **Figure 58**, the graph illustrates a flock performing above target where the information has been collated and graphed daily.

Figure 57
Components of the total energy requirements of broiler breeder females from 20-64 weeks of age.

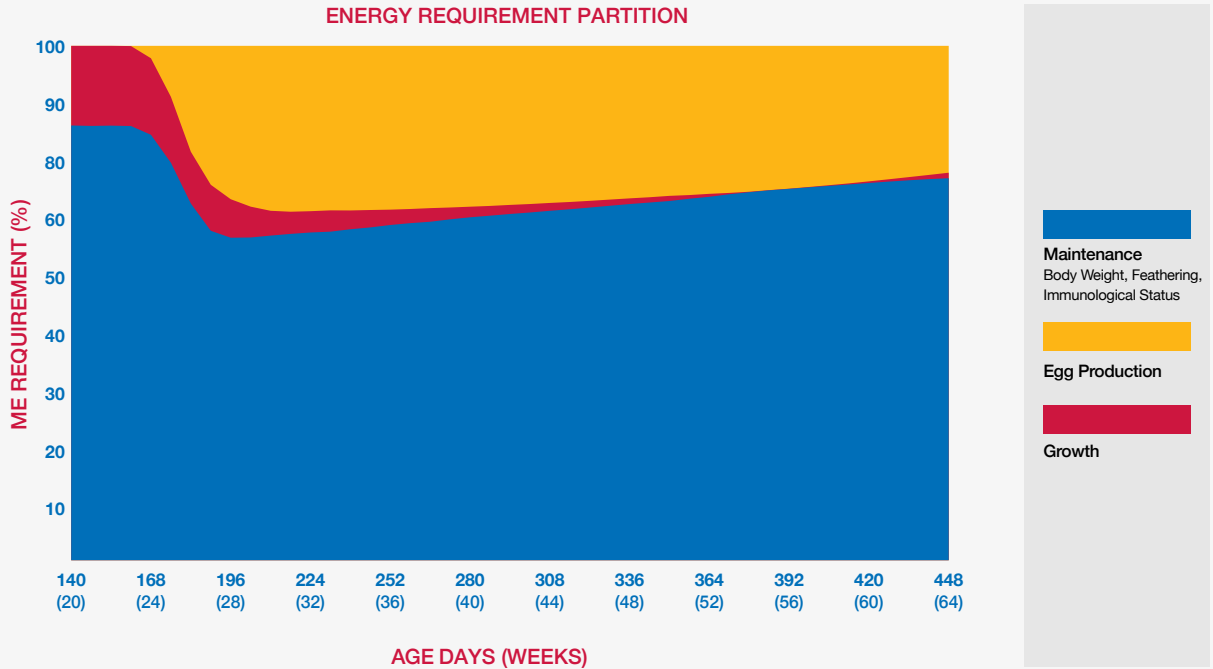
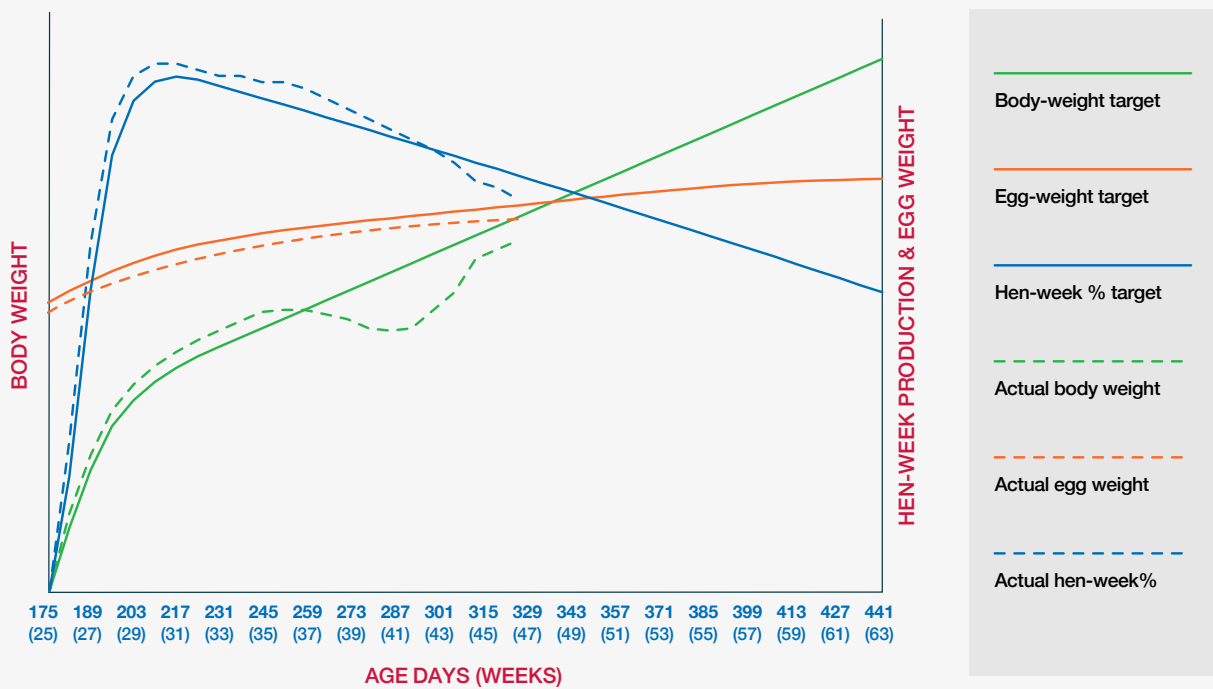
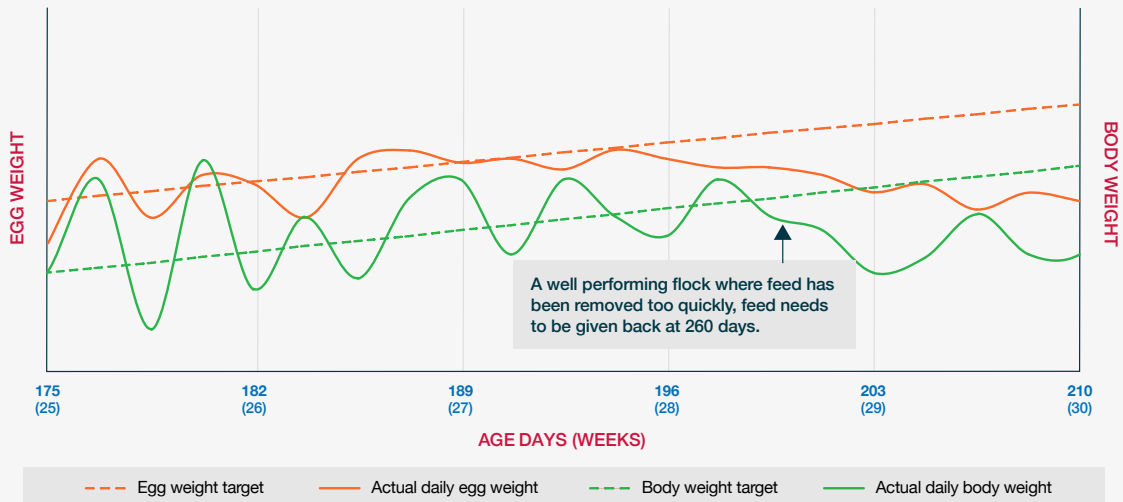

Figure 58
A graph illustrating the effects of underfeeding a flock performing above the hen week production target. The dotted lines indicate what would happen to performance if appropriate adjustments to feed reductions are not made.



While general trends in performance can be monitored, weekly recording does not allow sufficient early detection of potential performance issues in egg and body weight. Small but important changes will occur within days if nutrition is inadequate and it is recommended that daily egg weights and body weights are measured, recorded and monitored separately so that any gradual reduction in weight can be rapidly detected and acted upon (see **Figure 59**).

Figure 59
An example of a flock performing above hen-week target, where egg weight and body weight is falling away from the expected target in a consistent and continuous way over a period of at least 4 days.



Flocks Performing Below Target Recommendations

For flocks that perform below the published performance targets, feed reduction can be greater. Excess feed levels will result in such flocks becoming overweight, with poor persistency and increased egg weight (**Figure 60**). Daily egg weight, body weight and condition, production and feed clean-up times should be monitored closely to determine if feed reduction is being done correctly. In flocks that are performing below target, the overall feed reduction from peak to depletion will be more when compared to higher-performing flocks.

Figure 60
A graph illustrating a flock performing below the hen-week production target. The dotted lines indicate what would happen to performance if appropriate adjustments to feed reductions are not made.

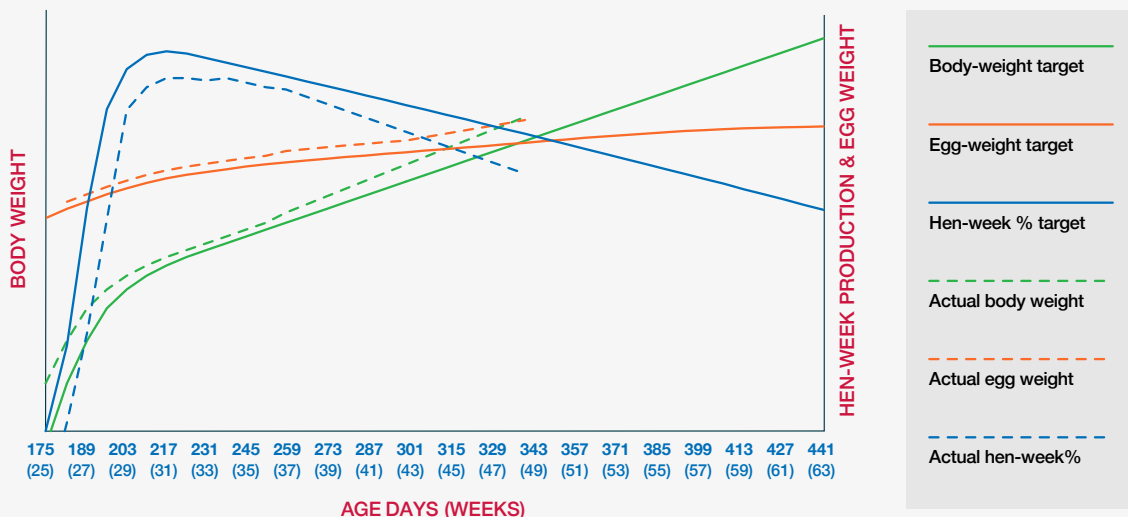

The early detection of potential performance issues requires that daily egg weights and body weights are measured, recorded and monitored separately. **Figure 61** illustrates how closer daily examination of the data indicates where there was a higher-than-expected increase in egg weight and then body weight, as feed reductions after peak have been too slow.

Figure 61
An example of a flock performing below hen week target where the increase in daily egg weight and body weight becomes continuously and consistently higher than expected over a period of at least 4 days.



Monitoring Post-Peak Feed Reduction

In any flock (high, average or low producing) after any post-peak feed reduction, the response to that feed reduction should be monitored carefully. If production, egg weight or body weight decreases more than expected, restore the feeding amount to the previous level and attempt to reduce the feed level again 5-7 days later (**Figure 62**).

Figure 62
An example of re-assessment of feed removal when the daily egg weight and body weight decreases in a consistent and continuous way by more than expected and feed levels need to be increased again.

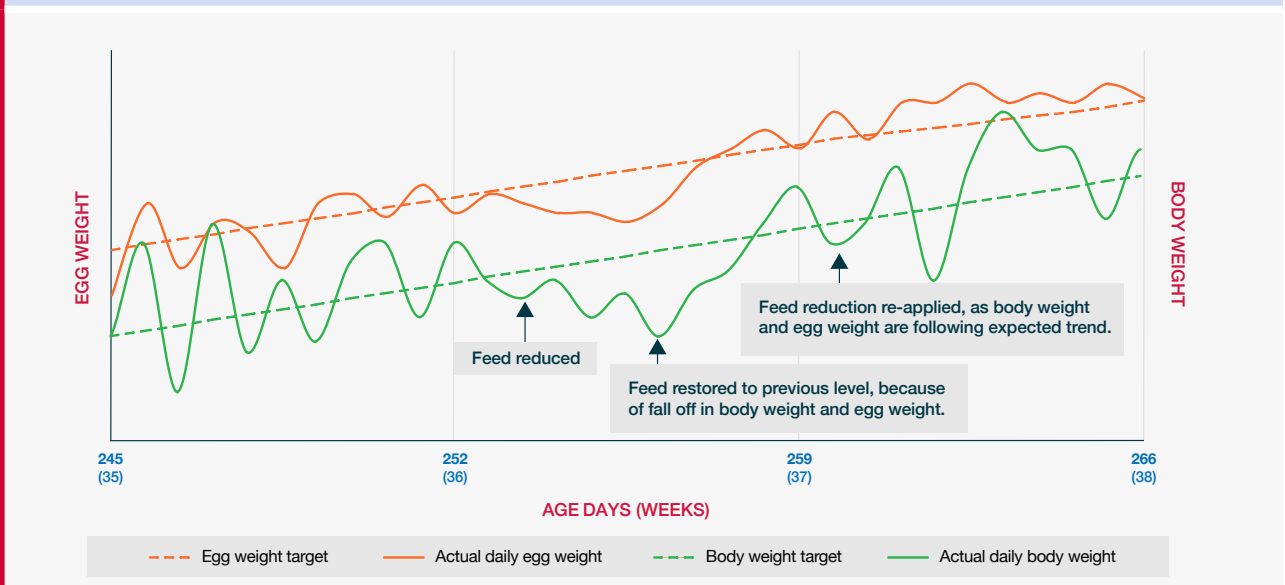

If egg weight or body weight increases more than expected and a decline in persistency occurs, the next feed reduction can be advanced (**Figure 63**). Closely monitor bird condition and adjust feed allocation accordingly.

Figure 63

An example of re-assessment of feed removal when the daily egg weight and body weight increases in a consistent and continuous way by more than expected and feed levels need to be reduced again.

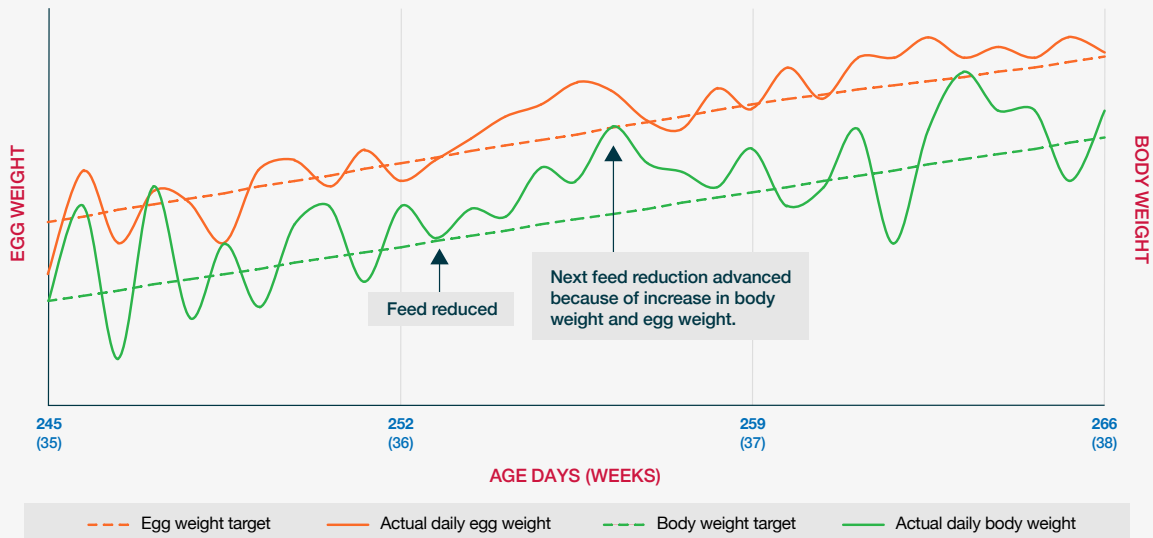

Post-Peak Feed Reductions and Environmental Temperature

If flocks peak during hot weather, feed should be reduced sooner and more quickly compared to more temperate conditions. However, as ambient temperatures change, feed levels should be reviewed and adjusted accordingly to ensure that birds' energy requirements are achieved. Monitor feed clean-up time so that any variations are managed.

Hens with poor feather cover will have a higher energy need, especially in cold environments. If calorie consumption is not correctly adjusted for cold temperatures and poor feather cover, it could result in a drop in production, hatchability and fertility, particularly during the last weeks of production.

KEY POINTS

Monitoring and control of body weight, condition and egg weight are major priorities post-peak.

Follow a post-peak feed reduction program that allows the birds to gain weight at a rate of 20 g/week (0.7 oz/week). This will help attain egg production, body-weight and egg-weight profiles.

Failure to control body weight from peak production will reduce production persistency and affect egg size.

Monitor and record daily body weight and egg weight and make weekly feeding decisions based on daily trends in relation to target.

Flocks producing at levels above egg-production targets may require more feed, and feed reductions should be of smaller amounts and more gradual.

If a flock peaks poorly, the feed withdrawal should be more rapid to avoid birds becoming fat.

As temperature changes, review and adjust feed levels to ensure correct energy requirements are achieved.

Poorly feathered hens will have a higher energy need to ensure drops in production do not occur.

Management of Males After Peak Production Through to Depletion

Objective

To maintain persistency of fertility.

Principles

Maintaining male condition and appropriately managing male numbers in lay are key for maintaining male fertility post-peak.

Procedures

Management principles and procedures for males in the post-peak period are similar to those used in the pre-peak period. Adjusting feed quantity to achieve a gradual but constant increase in weight as the male ages is the most effective means of controlling body weight and body condition. Thus persistency of fertility can be maintained. Mating ratios must also be optimized and managed.

A sample of males taken from throughout the house should be weighed frequently (at least once a week) to ensure this is achieved. At the same time as each male is weighed, they should be evaluated to determine if they are maintaining ideal physical condition, fleshing, and vent coloration. Maintaining these characteristics supports mating activity throughout the flock's life. It is important that an adequate sample size is weighed and assessed. A sample size that is too small (less than 10% of the population) can mislead the flock manager (for more information, refer to the section on *Monitoring Broiler Breeder Growth*).

Male feed allocations should continue to increase throughout the life of the flock. They should never be decreased. From around 30 weeks of age, males should be given feed increases that result in the desired average weekly body-weight gains. Actual changes in male feed quantities and frequency of feed increases should be made based on the sample evaluated, using body weight data and other husbandry information such as physical condition and fleshing and uniformity.

A planned mating ratio reduction program should be followed to maintain persistency of fertility (see section on *Management into Lay*). The optimum mating ratio should be maintained by removing males according to their physical condition (see section on *Assessment of Bird Physical Condition*).

Flocks with footpad problems have reduced mating and lower fertility. Litter condition and slat construction have a major effect on male footpad health and ultimately on the ability to mate. If litter becomes wet, compacted, or of inadequate volume, additional litter must be added to give males (and females) a comfortable area to walk on and mate. House ventilation, stocking density, drinker height and leakage, water pressure, feed quality, and bird health should be monitored.



KEY POINTS

Never decrease male feed allocation.

Ensure sufficient sample size is weighed.

Make sure feed increases account for body weight, fleshing and physical condition to maintain growth and persistency of fertility.

Maintain adequate quantities of dry litter to promote good footpad health.

Follow a planned male reduction program.



Notes

A series of horizontal dotted lines for taking notes.

Section 4: Monitoring Broiler Breeder Growth

Monitoring Broiler Breeder Growth

Objective

To manage bird development by obtaining an accurate estimate of the average body weight, CV% and/or uniformity for each population of birds.

Principles

Weigh birds at least weekly using a standardized, accurate and repeatable procedure. Target body weight-for-age and flock uniformity can then be controlled by management of feed allowance and feed distribution so that reproductive performance is maximized.

Body-Weight Weighing Methods

Flock growth and development are assessed by weighing representative samples of birds and comparing sample weights with target body-weight-for-age.

All measurement systems require calibration, and standard weights should be used to check that scales are weighing accurately. A calibration check should be made at the beginning and end of every sample weighing.

Two main weighing systems are available - manual and electronic. Either type of weighing scale can be used successfully, but the same scale should be used each time for reliable repeat measurements of an individual flock.

No matter which weighing system is used, the people handling birds should work in a calm manner, and be appropriately trained, considering bird welfare at all times.

Manual Weighing Scales

Several types of manual scales are available (**Figure 64**). These can be used to weigh birds to an accuracy of ± 20 g (0.04 lb) and have a capacity up to 7 kg (15 lb). Conventional (mechanical or dial) scales require manual data records to be kept and data calculations to be made manually.

Figure 64
Examples of manual scales for weighing birds.



OTHER USEFUL INFORMATION AVAILABLE



Broiler Breeder Management How To: Bulk Weigh Broiler Breeders



Broiler Breeder Management How To: Individually Weigh Broiler Breeders



How to video: Manual weighing

Electronic Weighing

Electronic scales (Figure 65) are available that record individual bird weights to the nearest gram (ounce), and can calculate and print-out the population statistics (Figure 66) automatically:

Total number of birds weighed.

Average weight of birds.

Deviation or range.

CV%.

Figure 65

Examples of electronic weighing scales for individual chick weights up to 7 days (left), electronic scales for individual bird weights after 7 days (middle) and platform scales (right) where birds weigh themselves individually.



Figure 66

Examples of a print-out from an automatic weigh scale (metric and imperial).

CURRENT DATA METRIC	
TOTAL WEIGHED:	79
AVERAGE WEIGHT:	0.471
DEVIATION:	0.048
C.V. (%) :	10.2

Band limits	Total
0.320 to 0.339	1
0.340 to 0.359	1
0.360 to 0.379	2
0.380 to 0.399	2
0.400 to 0.419	4
0.420 to 0.439	7
0.440 to 0.459	12
0.460 to 0.479	15
0.480 to 0.499	14
0.500 to 0.519	10
0.520 to 0.539	6
0.540 to 0.559	3
0.580 to 0.599	2

CURRENT DATA IMPERIAL	
TOTAL WEIGHED:	79
AVERAGE WEIGHT:	1.037
DEVIATION:	0.105
C.V. (%) :	10.2

Band limits	Total
0.705 to 0.747	1
0.750 to 0.791	1
0.794 to 0.836	2
0.838 to 0.880	2
0.882 to 0.924	4
0.926 to 0.968	7
0.970 to 1.012	12
1.014 to 1.056	15
1.058 to 1.100	14
1.102 to 1.144	10
1.146 to 1.188	6
1.190 to 1.232	3
1.279 to 1.321	2

Methodology for Sample Weighing

Birds should be weighed weekly from placement (day 0). At 0, 7 and 14 days of age, samples can be weighed in bulk (Figure 67). After 14 days of age, take individual bird weights.

At placement (day 0), at least three boxes of chicks should be bulk weighed per pen. The number of live chicks in each box and the weight of the chick box must be known in order to accurately calculate average chick weight. In addition, it is recommended to individually weigh the chicks in 1 box per pen at placement to assess chick quality and help determine initial early chick management procedures.

From 7 days onward, a minimum sample of 2% or 50 birds, whichever is greater, should be weighed per population. If birds are graded into different weight groups, the same minimum sample size of 2% or 50 birds (whichever is greater) per pen should be taken. At 7 and 14 days of age, bulk weigh 10-20 birds at a time until the entire sample (a minimum of 2% or 50 birds) has been weighed.

Bulk weighing allows the determination of average bird weight and average weekly body-weight gain. Comparison of average bird weight to target weight facilitates feeding decisions. However, for the determination of CV%, birds need to be weighed individually. See Table 10 for more information on the relationship between CV% and uniformity.

Figure 67
Example of bulk weighing chicks up to 14 days of age.



Recording of individual bird body weights should occur as early as is practically possible, generally between 14 and 21 days (2 and 3 weeks) of age. A minimum sample of 2% or 50 birds (whichever is greater) per population should be caught using catching frames and then individually weighed. All birds captured in the sample must be weighed in order to eliminate any selective bias. In rear, if the individual population exceeds 1,000 birds, 2 sample weighings should be taken from different locations in the pen or house (a minimum sample of 2% or 50 birds, whichever is greater, should be taken). In lay, samples should be taken from a minimum of 3 different locations within the population. In this way, samples will be as representative as possible and estimates of body weight will have increased accuracy.

Birds for sample weighing should be caught towards the middle of the pen away from any doors or the sides of the pen (Figure 68). Weighing needs to be completed on the same day each week and at the same hour of the day (4-6 hours after feeding).

Figure 68
Example of the correct sampling points within a house during the laying period.

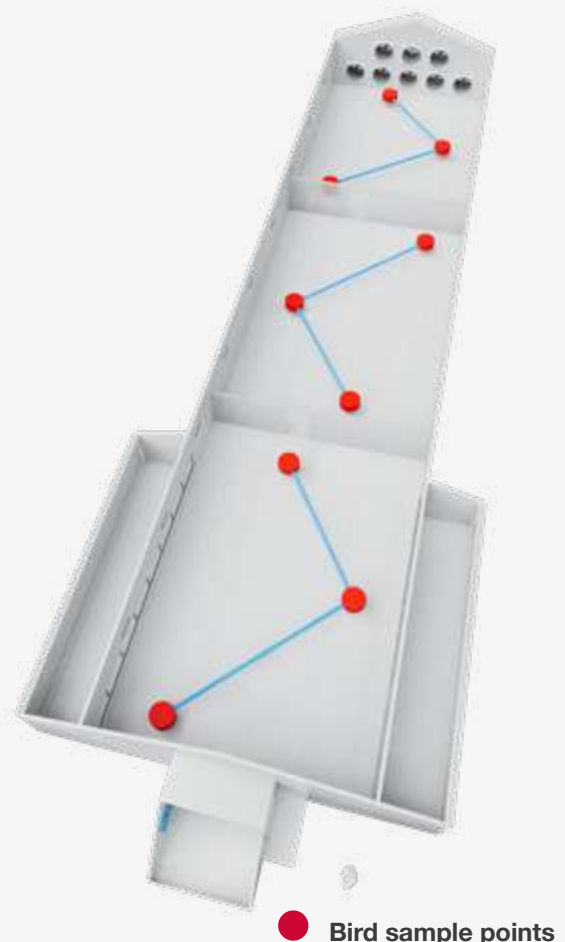

Procedures for Manual Scales

When manual scales are used, individual bird weights should be recorded on a weight-recording chart (Figure 69) as the birds are weighed.

Figure 69
Example of manual body-weight recording chart.

FARM	BREED	HOUSE	PEN	SEX	AGE	DATE
		2		Female	28	Mar-15
NUMBER WEIGHED	AVERAGE WEIGHT	TARGET WEIGHT	% Coefficient of variation			
212	469 g (1.03 lb)	450g (0.99lbs)	10.6			

WEIGHT		NUMBER OF BIRDS																													
LBS	G	1	2	3	4	5	6	7	8	9	10	11	12	13	14	15	16	17	18	19	20	21	22	23	24	25	26	27	28	29	30
0.00	00																														
0.04	20																														
0.09	40																														
0.13	60																														
0.18	80																														
0.22	100																														
0.26	120																														
0.31	140																														
0.35	160																														
0.40	180																														
0.44	200																														
0.49	220																														
0.53	240																														
0.57	260																														
0.62	280																														
0.66	300																														
0.71	320																														
0.75	340	x	x																												
0.79	360	x	x	x	x	x	x	x	x																						
0.84	380	x	x	x	x	x	x	x	x	x	x	x	x	x																	
0.88	400	x	x	x	x	x	x	x	x	x	x	x	x	x	x	x	x	x	x												
0.93	420	x	x	x	x	x	x	x	x	x	x	x	x	x	x	x	x	x	x	x	x	x	x	x	x						
0.97	440	x	x	x	x	x	x	x	x	x	x	x	x	x	x	x	x	x	x	x	x	x	x	x	x	x	x	x	x		
1.01	460	x	x	x	x	x	x	x	x	x	x	x	x	x	x	x	x	x	x	x	x	x	x	x	x	x	x	x	x	x	
1.06	480	x	x	x	x	x	x	x	x	x	x	x	x	x	x	x	x	x	x	x	x	x	x	x	x	x	x	x	x	x	
1.10	500	x	x	x	x	x	x	x	x	x	x	x	x	x	x	x	x	x	x	x	x	x	x	x	x	x	x	x	x	x	
1.15	520	x	x	x	x	x	x	x	x	x	x	x	x	x	x	x	x	x	x	x											
1.19	540	x	x	x	x	x	x	x	x	x	x	x	x																		
1.23	560	x	x	x	x																										
1.28	580																														
1.32	600																														
1.37	620																														
1.41	640																														
1.46	660																														
1.50	680																														
1.54	700																														
1.59	720																														
1.63	740																														
1.68	760																														
1.72	780																														
1.76	800																														
1.81	820																														
1.85	840																														
1.90	860																														
1.94	880																														

CV% = (Standard deviation* ÷ Average body weight) X 100
 *Standard deviation can be calculated in Excel or using a scientific calculator. Manual calculation formula can be found in Appendix 4.

After weighing, the following parameters can be calculated for the flock:

- _____ Average weight.
- _____ Weight range (highest body weight - lowest body weight).
- _____ CV %.

Average body weight and CV% should be plotted on a body-weight-for-age graph and compared to the target (**Figure 70**). Variation from performance targets, as well as trends in body weight development, will help to determine future.

Figure 70
Example of a chart for weekly recorded pen body weight and CV% compared with performance standards. In this example, body weight is on target and CV% is acceptable; feed increases should follow recommendations.

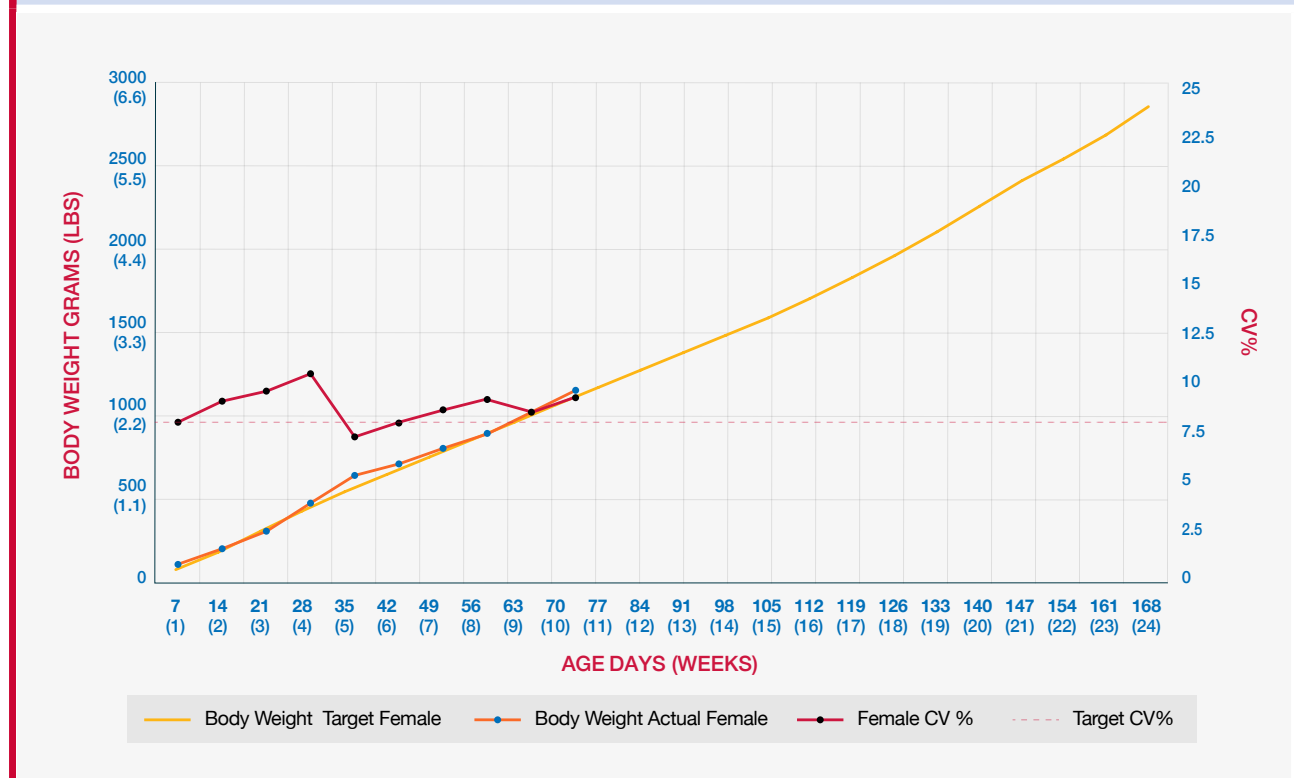

Procedures for Electronic Scales

If electronic scales are used, the population statistics (average weight, average body-weight gain, weight range and CV%) are automatically calculated and given on the print-out (**Figure 66**). As with manual scales, the average body weight and CV% figures should be plotted on a body-weight-for-age graph and compared to targets. Establishing variation from target will help determine future feed allocations.

Notes on Sample Weighing of Males

It is important to maintain male body weight and physical condition after mating-up, but accurately monitoring body weight can be more difficult at this time. False variation in bird weight over time may arise because of the difficulty in catching representative samples of males. So, it is crucial that a good male sample size (should be increased to a minimum of 10% of the population from mating-up), from different locations in the house, is weighed during lay.

Where an automatic (jump-on platform) weighing scale is set up in a house, male body weights must still be measured by hand weighing, using either manual or electronic scales. This is to verify the accuracy of the automatic system. Male sample sizes for automatic weighing systems can tend to be unrepresentative, because as males increase in size, they become less likely to use these platforms. Hand weighing (which should be completed weekly from point of lay as a matter of course) also provides an opportunity to check the physical condition of the males.

Note on Sample Weighing of Females

Where automatic (jump-on platform) weigh scales are used and the female weights from these indicate an unexpected variation or deviation from the expected target, a sample of birds should be re-weighed by hand weighing. If the variation is confirmed, the platform scales should be recalibrated to check that they are working correctly. Additional hand weighing of females is not required routinely, as with males.

Inconsistent Weight Data

If a sample weighing produces data that is inconsistent with the previous weights or expected gains, a second sample of birds should be weighed immediately as a check before any decisions on feed allowances are made. This will identify potential problems (e.g., improper sampling procedure, feed allowance errors, drinker failures or disease) that may need to be rectified.



KEY POINTS

Assess and manage growth and development in a flock by weighing representative samples of birds and comparing them with target weight-for-age.

Start sample weighing at day-old and continue at least weekly.

Take individual bird weights from 14-21 days of age for calculation of CV%.

Weigh a minimum of 50 birds or 2% of the female population (10% of the male population). However, all birds caught in the sample must be weighed.

Weigh birds at the same time each week using the same set of scales.

Check scale accuracy regularly.

Record and plot average body weight and CV% on a body-weight-for-age chart.

If sample weighing produces data inconsistent with previous weights or expected gains, weigh a second sample immediately.

Section 5: Assessment of Bird Physical Condition

Assessment of Bird Physical Condition

Objective

To ensure persistency of fertility and egg production by achieving optimum physical condition of males and females.

Principles

Regular physical assessment of birds provides additional information for guidance on required adjustments in management practices to ensure persistency of reproductive performance.

The physical assessment of birds within a flock involves monitoring a number of factors, including body weight, body condition (breast shape and degree of fleshing) and skeletal frame size to get a good overall view of bird condition, muscle tone, health and reproductive potential.

Assessing Bird Condition

Assessments of bird condition (e.g., fleshing, legs and feet) should be completed at least weekly, from placement through to depletion. This assessment should be done as part of the routine flock management procedures and will help to develop good stockmanship techniques in farm personnel. From these regular assessments, an awareness of what birds should both look and feel like at any given age can be developed. This knowledge will support management decisions and help recognize and solve problems. There are two opportunities to assess the flock - when birds are being weighed or when doing a house walk-through.

It is important that the flock is maintained in optimal condition throughout its life. However, it should be recognized that the optimum will vary slightly at different times during the production cycle, depending on, for example, whether or not the flock is approaching sexual maturity, is at peak production or is established in lay. At any point in time, an inadequate (under-fleshed or thin) or excessive (over-fleshed or fat) condition will have a negative impact on flock performance and should be avoided.

Particular attention to bird condition should be paid:

In the period leading up to the start of egg production (19-24 weeks of age) for females.

Throughout lay for males when a male reduction plan is being followed.

Weighing provides the ideal opportunity to assess bird physical condition. As a general rule, a minimum of 50 birds or 2% of the population (whichever is greater) should be sampled for females, and a minimum of 10% of the population should be sampled for males (for more information see the section on *Monitoring Broiler Breeder Growth*). Physical condition should be routinely assessed and recorded on all birds sampled for weighing.

In addition, at least once per week during a walk through of the house, individual birds should be picked up, and their physical condition assessed. As a guide, a minimum of 20-30 females and 15 males should be selected at random, and their physical condition assessed.

✓ KEY POINTS

Regular assessments of physical condition should be made throughout the life of the flock.

Using a combination of physical assessments will provide a better indication of bird condition and fitness-for-purpose and thus facilitate better management decisions (feeding allocation and implementation of male number reduction plans).

A representative sample of the population should be assessed individually at least weekly during weighing to determine overall flock condition. It is good practice to catch and physically assess individual birds while doing a house walk-through.

Assessment of Male Condition

Males that are in good physical condition will have good fertility. Completing routine physical assessments of male condition throughout the life of the flock will help ensure that optimum fertility is achieved.

Any personnel handling birds should do so with due care and attention and must be appropriately trained.

Rear

During rear, it is important that birds achieve target body weight and that the flock is uniform in its development. Skeletal frame size and shank length can be a useful means of visually comparing male development and are supportive management tools.

Up to 63 days (9 weeks) of age there is a positive relationship between body weight, frame size and shank length (**Figure 71**). In general, birds that achieve the recommended body-weight target during rear will also achieve good uniform development of the shank and frame (skeleton). Observing birds at the feed track and/or at nipple or bell drinkers, and looking at the variation in shank length provides an opportunity to see if there is a high level of variability within a population (suggesting poor uniformity). The reasons for this variability should be investigated (e.g., poor feed distribution, inadequate feeder space, health issues or poor brooding conditions).

Figure 71
Shank length in males. The male on the left has poorer development of the shank in both length and diameter.



Birds that follow the recommended body-weight profile in rear should also achieve a body condition that is acceptable. However, regular and routine monitoring of male fleshing in conjunction with measurement of body weight can provide a more accurate indicator of overall body condition and establish more appropriate management and feeding strategies. To achieve this, males should be handled regularly and physical body condition assessed at least weekly during weighing from placement, paying particular attention between 15 weeks of age and the start of production in preparation for sexual maturity. It is also important to be aware of general health, alertness and activity.

Lay

Physical Assessment of Male Condition for Removing Males as Part of a Male Reduction Plan

A planned mating ratio reduction program (**Table 19**) should be followed to maintain persistency of fertility. The optimum mating ratio is maintained by removing males from the flock that are in poor physical condition and not working.

Table 19
A guide to typical mating ratios.

Age		Number of Good Quality Males Per 100 Females
Days	Weeks	
154 - 168	22 - 24	9.50 - 10.00
168 - 210	24 - 30	8.50 - 9.50
210 - 245	30 - 35	8.00 - 8.50
245 - 280	35 - 40	7.50 - 8.00
280 - 350	40 - 50	7.00 - 7.50
350 to depletion	50 to depletion	6.50 - 7.00

Assessment of male condition for managing mating ratios should be routinely made during weighing, but can also be done on individual males when walking through the flock.

Physical assessment of male condition must be comprehensive and include:

Alertness and activity.

Body condition (fleshing) - shape and softness or hardness of breast muscle tone.

Legs and feet - the legs should be straight with no bent toes, and the footpads should be free from abrasions.

Head - males should have a uniform, intense red color around the comb, wattle, and eye area. Beaks should be uniform in shape.

Feathering - a good-quality male will exhibit some partial feather loss, especially around the shoulders and thighs.

Vent - should show some feather wear, be large and moist, with good (red) coloration.

Body weight - according to target.

Alertness and Activity

The flock should be observed throughout the day to monitor mating activity, feeding, resting location, daytime distribution and distribution immediately prior to lights out. Males should be alert, active and evenly distributed over the litter (scratch) area for most of the light period (**Figure 72**). They should not be concentrated on the slats or hiding under equipment. Males identified as not being alert and active should be removed. If the mating activity of the flock is observed to be lower than expected, the reason should be investigated (e.g., poor male condition, sexual maturity between males and females not synchronized, inadequate feed distribution and male feed allocation).

Figure 72
Good distribution of alert males within a flock.



Monitoring Body Condition (Breast Shape or Fleshing) in Males

Breast shape or fleshing is a good indicator of bird condition and is particularly useful for males. Birds that are over- or under-fleshed are more likely to have problems with mating and fertility.

Traditionally, body weight has been the main driver for male broiler breeder management decisions, but using body weight alone can be misleading. For example, it is possible to have two birds of the same age and body weight that differ in physical appearance and body condition (one could be skeletally smaller or larger, and broader or leaner - **Figure 73**). These birds would require different management, for example, feed levels and feeder height, to achieve good levels of fertility.

Observation and awareness of male condition are important throughout the bird's entire life. Achieving and maintaining optimum body condition, as well as ensuring that there is no body condition deterioration at any stage, are critical to male performance.

However, particular attention is recommended:

At the onset of physical mating activity to ensure that early flock fertility and productivity are maximized.

Post-peak to optimize lifetime flock fertility.

Figure 73
An example of two adult male birds of the same weight and age but differing body condition. The bird on the left is shorter and broader, and the bird on the right taller and leaner, but the body weight of the two birds is equal.

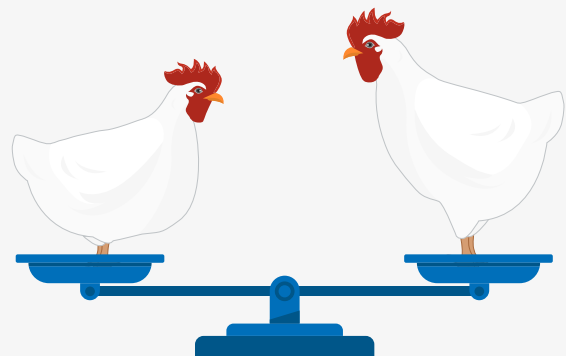

Body Condition Scoring System

Body condition (fleshing of males) should be assessed on a scale of 1 to 5: a score of 1 being under-fleshed, and a score of 5 being very over-fleshed. The differences between the 5 scores are illustrated in **Figure 74**.

Figure 74
Scoring system to assess bird body condition (fleshing).

Male Fleshing Scores

1

Sunken V

Should not be seen within the flock.



Male is emaciated, keel bone is prominent, practically no flesh to measure.

2

Standard V

20-30 weeks of age.



Keel bone is prominent, but male is carrying some fleshing.

3

Standard U

30-50 weeks of age.



Chest is just beginning to round out, keel bone is felt down the middle, carrying a decent amount of fleshing.

4

Wide U

>50 weeks of age.



Chest is getting wider, but still a U shape, practically no keel bone left to be felt.

5

Dimpled U

Should not be seen within the flock.



So grossly over-fleshed that the breast dimples, sinking back to the keel.

Procedure for Assessing Body Condition (Breast Shape or Fleshing)

Breast shape and fleshing should be assessed at least once a week during weighing. All bird samples being weighed should be assessed.

To assess fleshing, run the hand along the length of the breast (over the keel bone), feeling the shape, volume, and tone of the breast muscle (**Figure 75**).

Figure 75
Assessing male condition. While holding the bird by both legs, the hand is run over the keel bone, and the prominence of the keel bone and the amount, shape and firmness of the breast on either side of the keel assessed.



A score of 1-5 indicating the amount and shape of breast should be given to each bird. Scores should be recorded, and the average score for the flock determined each week. The trend in bird condition over time should also be monitored.

In addition to the amount of breast fleshing, the firmness of the breast muscle needs to be considered. For the period between 28 and 35 weeks of age (just past flock peak) the muscle tone should be firm. Firmness tests (**Figure 76**) are often used to help determine breast muscle firmness.

Figure 76
Example of firmness testing.

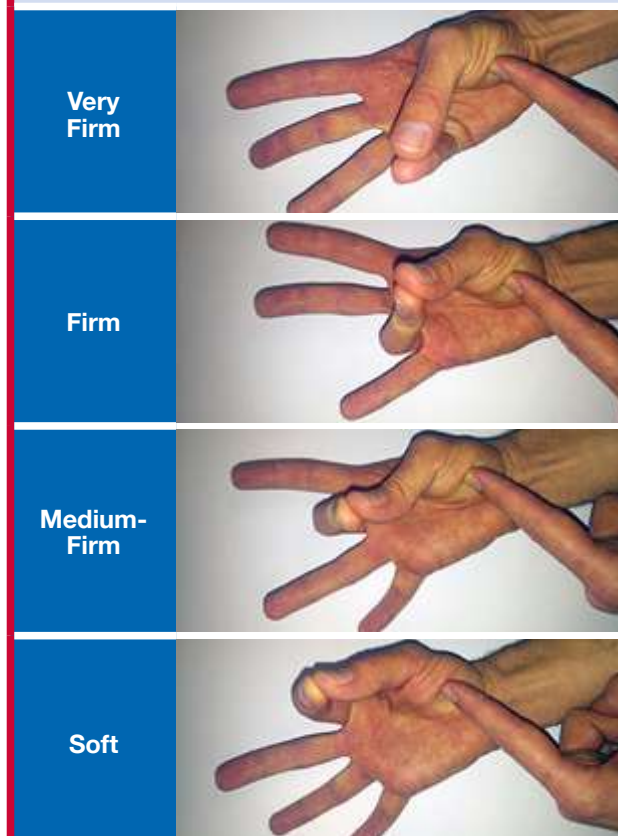

For males, a score of “very firm” to “firm” is ideal. If firmness scores change to “medium-firm” or “soft” it means that the bird is losing muscle tone and corrective action is required (review feed volumes and feed management procedures)

As a simple test to check muscle firmness, open and relax the palm of your hand. Gently press the tip of the pinky and thumb together, and using the index finger of the opposite hand, feel the fleshy area below the thumb. It should feel quite firm, like that of a steak that is well done. Repeat on the remaining fingers to achieve firm (ring finger), medium-firm (middle finger) and soft (index finger) scores.

During assessment, the tightness of the skin covering the breast will give an indication if birds are changing direction - very loose skin will accompany a “soft firmness” whereas taught skin will accompany “very firm” firmness.

OTHER USEFUL INFORMATION AVAILABLE



How To Video: Assessment of a Male 18 Weeks

Body condition scores should be taken into consideration, along with body weight and uniformity, to provide the basis for appropriate adjustments in bird management. Examples of how body condition assessments might be used in this way are given in **Table 20**.

Ideally, body condition should be assessed by the same person each week, as interpretation of the assessment of body condition score will differ slightly between individuals. In addition, while the average condition score for the males in a flock is 2, the optimum condition score for individual flocks may vary slightly around the ideal.

Table 20
Examples of how male condition can be used in conjunction with body weight to determine appropriate flock management strategies.

	Flock Age	Average Body Weight	Average Condition Score Week 35*	Average Condition Score Week 38*	Average Condition Score Week 40*	Management Strategy
Sample 1	40 weeks	Target	2.6	2.7	2.75	Body weight on target and condition good. Give recommended feed increase.
Sample 2	40 weeks	Target	2.6	2.6	2.4	Body weight on target but condition score falling. Consider giving additional feed increase above recommendation, and investigate reason for declining condition.
Sample 3	40 weeks	200 g (0.4 lb) below target	2.5	2.5	2.45	Body weight below target, condition score low (thin birds). Check that condition score is correct. If confirmed, give additional feed increase. Investigate feed volumes, uniformity of feed distribution, and effectiveness of separate-sex feeding.
Sample 4	40 weeks	200 g (0.4 lb) above target	2.9	3	3.3	Body weight over target and condition score high (fat birds). Verify that feed distribution and separate-sex feeding systems are working optimally. Feed to maintain increased body weight.

*Average condition score corresponds to group of male sample weighed. Ensure the scales are accurate and calibrated before weighing.

 **KEY POINTS**

Body condition (fleshing) should be assessed at least weekly during weighing.

All birds being weighed should be assessed and their condition given a score of 1-5 (1 being under-fleshed, 2-3 being ideal and 4-5 being over-fleshed).

Condition scores should be recorded and the average for the flock calculated. The trend over time should also be monitored.

Body condition should be used in conjunction with body weight and uniformity to determine appropriate management and feeding strategies.

Legs and Feet

To maintain activity and optimal fertility levels within a flock, males must have good feet and legs (**Figure 77**). Legs should be straight with no bent toes. The footpads should be clean and free from physical damage. Abrasions and cracks on the feet may lead to infection and discomfort that will reduce welfare and mating activity. Any male showing poor feet and leg condition should be removed from the flock.

Figure 77
Good leg health in males.



Head

Males in good condition that are working well will have a uniform, intense red color around the comb, wattle, and eye area (**Figure 78**). Under normal conditions, the face of a healthy, well-conditioned male will redden up from the face in towards the eye. Conversely, the face of a male in poorer condition will start to lose color from the eye outwards. Males with low face color may have a low mating activity and should be considered for removal.

Figure 78
A healthy, active male showing a red face and comb (top), and a male in poorer condition, showing paleness around the eye (bottom).





Feathering

In production, a good-quality male that is working well will exhibit some partial feather loss, especially around the shoulders, thighs, breast and tail (**Figure 79**). Well-feathered males generally have low mating activity and should be considered for removal.

Figure 79

An active male showing some feather wear (left), and an inactive male showing no feather wear (right).



OTHER USEFUL
INFORMATION AVAILABLE



How To Video: Assessment of a Male 57 Weeks

Vent (Cloaca) Condition

During weekly weighing, male vent condition should be assessed. Assessing the intensity of redness and moistness of the vent (**Figure 80**) is a useful management tool for assessing male condition and mating activity within the flock. The aim is to maintain a uniform high coloration of the vent. Healthy, well-conditioned males working optimally will display a redder vent color. The color of the vent is related to the frequency of mating and is as a result of contact friction with the female. The vent will be moist, and there will be some feather loss around the vent area. Males of poor condition with low mating activity will have a pale vent color. The vent will be small and dry with good feather cover.

Figure 80
Variation in vent color used to indicate degree of mating activity in males. The vent at the top is from a working male and has a good red color, is moist and shows some sign of feather wear. The vent on the bottom is pale in color, small, dry and shows no sign of feather wear.



✓ KEY POINTS

During lay, a male reduction plan must be followed to maintain optimal flock fertility.

The decision about which males should be removed from the flock is based upon a general assessment of male physical condition.

Attributes that should be looked at include:

- Body weight.
- Body condition.
- Legs and feet.
- Face color.
- Vent condition.
- Alertness and activity.

i OTHER USEFUL INFORMATION AVAILABLE



Aviagen Poster: Male Assessment in Production

Assessment of Female Condition

The weekly sample weighing also provides an ideal opportunity to assess female physical condition. As with males, it is good management practice to pick up and assess the condition of individual females while walking through the flock.

Any personnel handling birds should do so with due care and attention, and must be appropriately trained.

Rear

In rear, assessment of bird physical condition is based primarily on body-weight monitoring and skeletal size (skeletal frame size and shank length). However, it is also important to be aware of the degree of fleshing, general health, alertness and activity. Achieving uniform growth and development of the females during rear is key to subsequent laying performance. Variation in frame size within the female population can provide a visual indicator of poor flock uniformity (determination of body weight CV% should be used to confirm this). When poor flock uniformity occurs, the cause(s) should be identified (e.g., poor feed distribution, inadequate feeder space, disease, poor brooding conditions).

Lay

During lay, the main drivers for decisions on feeding management for females are body weight, egg production and egg weight. Regular monitoring of pin-bone spacing, fleshing and fat-pad development can provide useful supportive management information.

Pin-bone Spacing

Measurement of the spacing between the pin (pelvic) bones is a useful management tool for determining the stage of sexual development in growing females, and hence, when lay is about to commence. Under normal conditions, the spacing between the pin bones will gradually increase as the bird ages until it becomes maximal at point of lay (**Table 21**). If pin-bone spacing does not develop as indicated in **Table 21** (i.e., is below 1-1½ fingers [1.9-2.5 cm; 0.75-1 in] at the intended age of light stimulation), or if there is a big variation in pin-bone spacing within the flock, then light stimulation should be delayed.



OTHER USEFUL INFORMATION AVAILABLE



*Broiler Breeder Management How To:
Measure Pin Bone Spacing*

Table 21
Changes in pin bone spacing with age.

Age	Pin Bone Spacing	Approximate Distance Between Pin Bones
84-91 days	Closed	-
119 days	1 finger	1.9-2.5 cm (0.75 in-1 in)
21 days before first egg	1½ fingers	
10 days before first egg	2-2½ fingers	3.8-4.2 cm (1.5 in-1.7 in)
Point of lay	3 fingers	5-6 cm (2-2.5 in)

*Pin bone scoring should always be performed by the same person, if possible, for scoring consistency.

Pin-bone spacing should be monitored regularly from 15 to 16 weeks (105 to 112 days) of age up to point of lay (**Figure 81**). Ideally, this should be done every time the house is walked, but at a minimum it should be done weekly. The term “finger” is relative to hand size and will vary from person to person. Ideally, it should be the same person who measures pin-bone spacing from week to week. As a general rule, birds are at the point of lay when the distance between the pin bones is about 3 fingers (or approximately 5-6 cm [2-2.5 in]). A thin layer of fat covering the pin bones (pin bones should feel rounded) indicates that the birds are laying down abdominal fat in readiness for the onset of lay. No fat covering (pin bones feel sharp) may indicate that the birds are not ready to be light stimulated.

Figure 81
Assessment of pin-bone spacing in females.



Monitoring Body Condition in Females

In general, a uniform flock of females achieving the target body-weight profile in rear should also achieve an optimal body condition.

It is important to ensure that females do not become either over- or under-fleshed. Regardless of age, females that are substantially over-fleshed are likely to be heavy and may have increased fat deposits, while under-fleshed females are likely to be in poor condition. Both situations impact lifetime reproductive performance. As is the case for males, a sample of females should be handled frequently (at least weekly), and body condition (fleshing) assessed to ensure that the flock remains in good health and condition to maintain reproductive performance.

Different to that used for males, a score of 1-3 is used for a female scoring system (**Figure 82**). However, the way in which the flock results are interpreted and used is different, as the female body shape differs to that of males and it is not recommended to remove individual females from a flock based on this assessment. For females, it is critical to achieve target body weights and modify feed allocation appropriately to egg production levels and egg weight. Fleshing assessment in females tends to be a supportive management tool (rather than pivotal, as is the case for the males in lay).

Figure 82
CT scanner images illustrating the fleshing scoring system for assessing bird condition. These pictures show 40-week-old females. The top 3 images show the whole bird (the dotted lines indicate the position at which the cross-section images were taken). The bottom 3 images show an internal cross section view of the breast.

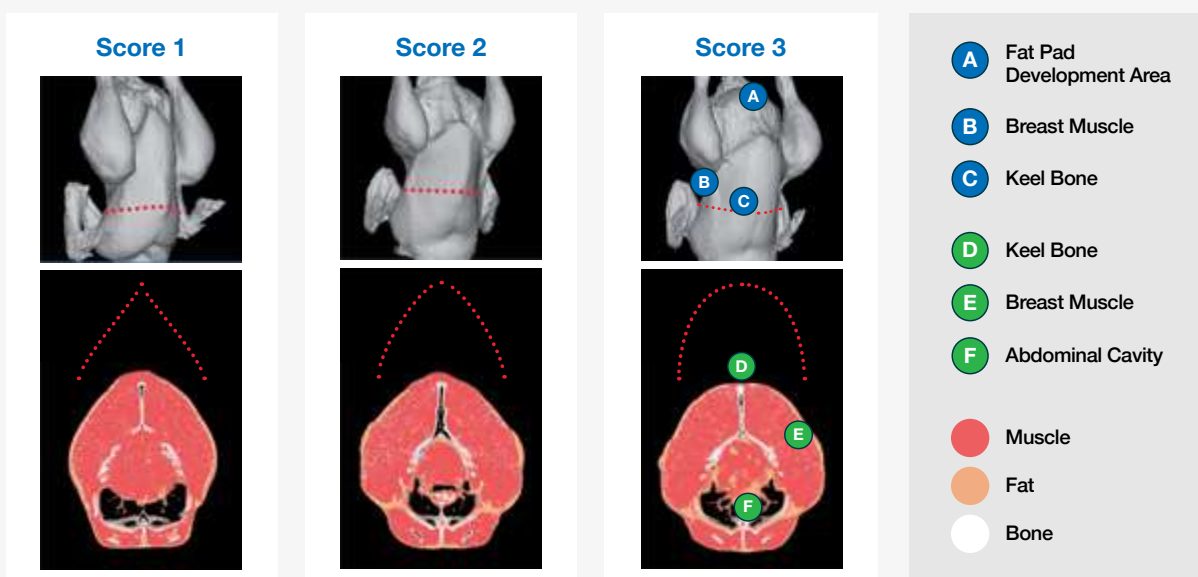

In rear, the appropriate flock management should minimize the incidence of score 1 (under-fleshed) and score 3 (over-fleshed) birds in the flock.

In lay, it is preferable that the average flock score is between 2.0 to 2.5, and that the occurrence of score 1 females is minimized because under-fleshed females are likely to have lower egg outputs. However, a body condition score 3 can be satisfactory for females in lay, as a fleshy female can still have a good reproductive output.

OTHER USEFUL INFORMATION AVAILABLE



How To Video: Female 18 Weeks

Abdominal Fat Pad

In lay, monitoring fat pad deposition (**Figure 83**) is another supportive management tool that can help provide a better overall assessment of bird condition.

Figure 83
Assessing abdominal fat pad in a female broiler breeder. To assess abdominal fat pad content, gently feel the area just below the cloaca with a cupped hand. Post-peak abdominal fat pad should not exceed the level shown here.



There is little fat pad development in properly fleshed broiler breeders prior to onset of lay. Significant development of the fat pad generally occurs after sexual maturity is attained, with the fat pad reaching its maximum size about 2 weeks before peak egg production. The abdominal fat pad in females can provide an energy reserve to support maximum egg production, but any excess fat, particularly after peak, will be detrimental to persistency of egg production, fertility and hatchability, and it may reduce livability. A positive relationship exists between body weight and fat pad development, so heavier females are likely to have increased fat levels that may affect productivity (**Figure 84**).

Figure 84
Increases in fat pad with weight. The pictures show a longitudinal cross section (cloaca on left, head [not shown] on right) of the females. The birds were 40 weeks of age. The female on the left is losing condition and is below target weight with little fat. Egg production in such a bird is likely to be reduced or even cease. The bird on the right has a large fat pad and shows fat accumulations around the internal organs. Rate and persistency of lay are likely to be reduced in this bird



From the start of lay, females should be routinely (at least weekly) assessed to monitor the progress of fat pad development. The actual degree of fat pad deposition will vary from bird to bird. The objective after peak production is to maintain the female at a physical mature weight, but to minimize the development of excess fat pad. As a guide, maximum fat pad volume should be no more than the size of an average person's cupped hand or a large egg (roughly 8-10 cm [3-4 in]).

KEY POINTS

Regular assessments of female physical condition (fleshing) should be made throughout the life of the flock.

Using a combination of physical assessments (body weight, fleshing, fat pad, and pin-bone spacing) provides a reliable indication of overall female condition upon which appropriate management decisions can be based.

Section 6: Care of Hatching Eggs on Farm

Care of Hatching Eggs

Objective

To manage egg storage conditions so that there is as little bacterial contamination and age related deterioration in the blastoderm and egg contents as possible, in order to optimize lifetime hatchability and chick quality.

Principles

Eggs must be kept in clean conditions and at the correct temperature and humidity to achieve the best hatchability. Satisfactory procedures for collection, disinfection, cooling and storage of the eggs should be in place, and each process should be carried out so that embryonic development is not compromised.

Why do Hatching Eggs Need Care?

The fertile hatching egg is usually free of microbial contamination when it is laid, with the embryo stage and egg contents all in a state to support good hatchability. The eggshell and albumen protects the embryo from damage and prevents bacterial contamination using a combination of physical protection and antimicrobial

proteins. Embryo growth and albumen height can both be kept in optimal condition by maintaining constant egg storage temperatures, below 18°C (64.4°F).

The farm can minimize bacterial contamination by keeping the eggshell clean, and avoiding any water droplets forming on the eggshell surface, whether through condensation, disinfectant fogging or egg washing.

Egg Fertilization and Early Embryo Development

Each day, the hen's ovary sheds one ovum, which is immediately engulfed by the infundibulum.

Figure 85 shows the ovary and oviduct of the laying hen, demonstrating why the embryo has already started to develop by the time the egg is fully formed and laid.

Fertilization must take place immediately after ovulation, before the vitelline membrane starts to form, about 20 minutes after ovulation. The sperm are stored after mating in sperm storage tubules at the utero-vaginal junction and must travel up the oviduct to be ready immediately before ovulation.

Figure 85
A diagram showing the ovary and oviduct. Key events are labelled.

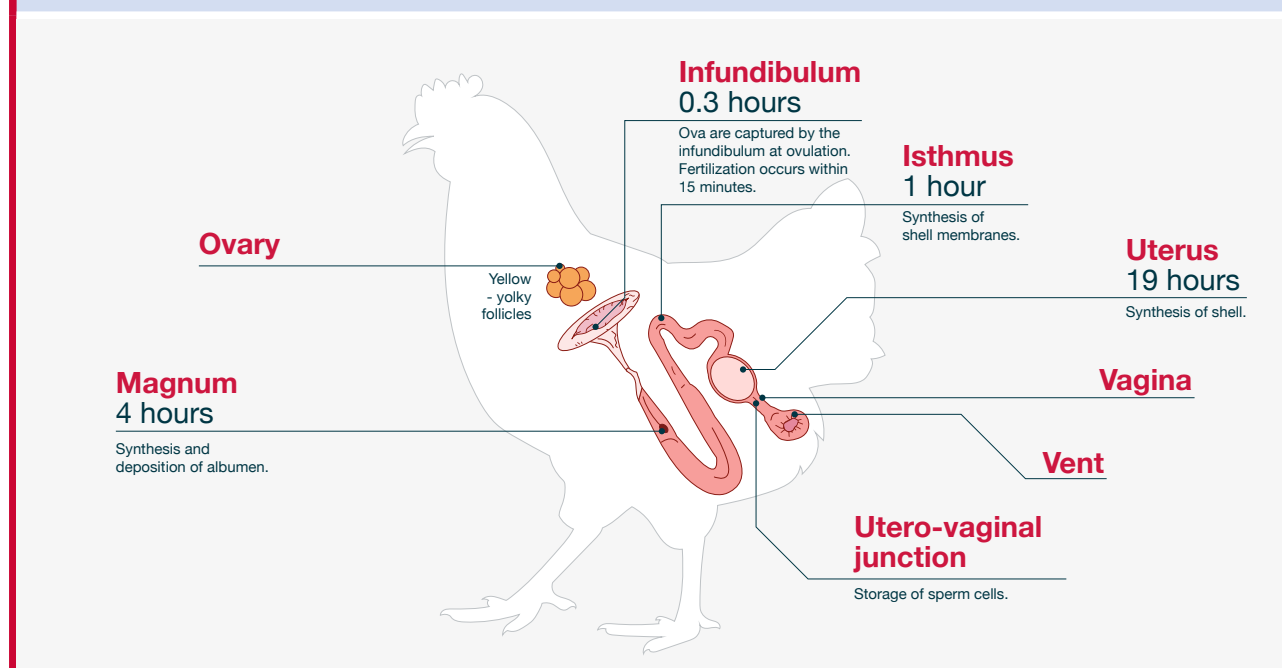

After fertilization, the blastoderm will keep growing and developing, as long as it is at body temperature in the oviduct, while the albumen is formed (4 hours), shell membranes are secreted (1 hour) and the eggshell is laid down (19 hours). During the 24 hours in the oviduct, the embryo will develop through a series of well-defined stages. By the time the egg is laid, it will look like a slightly raised white ring with a darker center (**Figure 86**).

Figure 86
The development of the blastoderm after 24 hours in the oviduct (top). A non-fertile egg (bottom) is also shown for comparison.

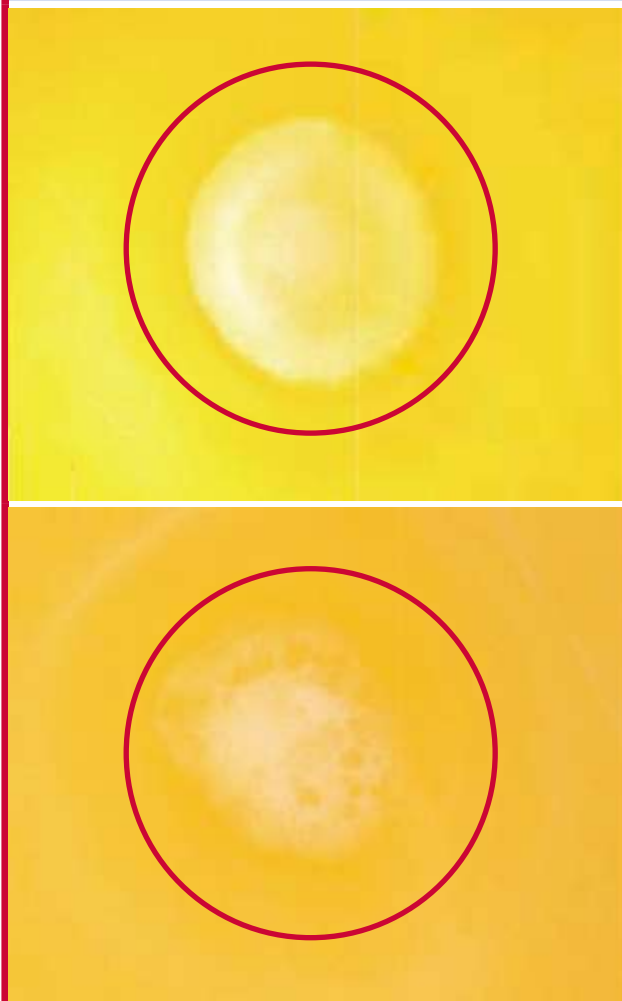

As the eggs cool down after laying, embryo growth and development slow. Normal growth stops at around 26°C (78.8°F) to 29°C (84.2°F), with much slower growth identifiable below 26°C (78.8°F). All development stops completely at 15°C (59.0°F). The development stages across a batch of eggs will affect their ability to survive fluctuating temperatures. Any variability in development will also have an impact on the hatch window; the more variable the embryo stage at the start of incubation, the wider the hatch window.

Bacterial Contamination – Barriers and Facilitators

Barriers

Eggshell and the Cuticle

The oviduct is usually free of micro-organisms that can damage hatchability or chick quality, and at the point of lay, 90% or more eggs are virtually sterile. Contamination occurs only after oviposition. The eggshell serves as a physical barrier to bacterial contamination, which is greatly enhanced by an outermost cuticle layer.

The cuticle is a thin protein coat that allows gases, but not micro-organisms, to penetrate through. Immediately after the egg is laid, it is still not completely formed (this is why the shell surface looks wet and under magnification; it has an open, sponge-like appearance). The cuticle hardens to a flatter, flake-like surface within 2-3 minutes of the egg being laid. Until this process is complete, it is easy for microbes to penetrate the cuticle and pass down the pores and into the egg. **Figure 87** is an example of a cross-section of the eggshell, showing the cuticle in its normal state immediately after the egg is laid. At this point the cuticle will look wet.

Figure 87
Cross-section showing the structure of the eggshell and layers of protection.

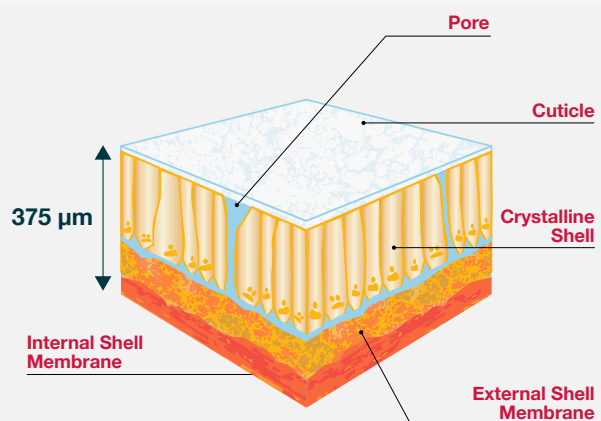

The status of the cuticle, either uncured or dry, affects its ability to prevent contamination of the internal egg contents. **Figure 88** shows examples of eggshells held in direct contact with a dropping immediately after lay (left), and again after the cuticle was dry (right). Because the cuticle is not fully functional when the egg is laid, nest box hygiene and frequent egg collections are important when trying to limit bacterial contamination in hatching eggs. The surface on which eggs are laid must be free of contamination, with nest liners and egg collection belts inspected and cleaned daily.

Figure 88
Bacteria pass through the uncured cuticle within 15 minutes of contact time (left), whereas the same exposure after the cuticle is fully formed is not associated with contamination (right). Image courtesy of Nick Sparks, Dean of Faculty, Scotland's Rural College



Antimicrobial Proteins

Both the cuticle and the albumen contain antimicrobial proteins, which help control the rate at which contamination spreads into and within the egg. They tend to deteriorate in warm conditions and over time. That is why contamination gets worse as dirty eggs age.

Facilitators

Water and Humidity

Once the cuticle is fully cured, it protects the egg contents effectively, provided that the egg surface is not allowed to become wet. Water on the eggshell surface makes it much easier for micro-organisms to move across the shell and to enter the shell pores. Water may become an issue when:

Egg surface disinfection uses an aqueous solution (especially if the bacterial kill rate is relatively low).

Eggs are washed to remove gross contamination.

Eggs are moved from a cooler egg store into a warmer, more humid environment causing condensation on the shell surface.

Condensation

When cold eggs are moved into a warm, humid atmosphere, condensation will form on the egg surface. This can occur when they are transported from a cold egg store on the farm to a warm hatchery. For example, if eggs are moved from an egg store on the farm that is 15°C (59.0°F) into an egg room or setter room at the hatchery that is 25°C (77.0°F), condensation will occur at any humidity level above 60% RH (**Table 22**). If eggs are sweating, they should not be fumigated or put into a cold egg store until they are dry.

Table 22
The lowest temperatures (°C [°F]) in a room or setter into which eggs are being moved from an egg store at which condensation will occur.

Egg Store Temperature °C (°F)	Relative Humidity (%RH) of Room Eggs Moved Into				
	40	50	60	70	80
12 (54)	27 (81)	23 (73)	20 (68)	18 (64)	15 (59)
13 (55)	28 (82)	24 (75)	21 (70)	19 (66)	16 (61)
14 (57)	29 (84)	25 (77)	22 (72)	20 (68)	17 (63)
15 (59)	30 (86)	26 (79)	23 (73)	21 (70)	18 (64)
16 (61)	31 (88)	27 (81)	24 (75)	22 (72)	19 (66)
17 (63)	32 (90)	28 (82)	25 (77)	23 (73)	20 (68)
18 (64)	33 (91)	29 (84)	26 (79)	24 (75)	21 (70)

To avoid condensation, the eggshell temperature needs to be higher than that given in **Table 22**.

If eggs are to be stored at a temperature which can easily cause condensation, such as moving from farm to truck, some adjustments may be required. In tropical climates where humidity levels frequently exceed 70% (air temperature of approximately 28°C [82.4°F]), the best course of action is to avoid cooling the eggs on the farm, instead making sure that the eggs are transported from farm to hatchery at the end of each day. However, in temperate regions, it is unlikely that the outside temperature will be both hot and humid enough to cause condensation, so eggs are best cooled on the farm and then moved to the hatchery less frequently.

Best Practice for Care of Hatching Eggs

Disinfectant Fogging

Disinfectant fogging is used when the hatching egg disinfectant on the farm is diluted with water and applied using a sprayer or fogger. In theory, if the droplet size is small enough, the eggs will not become wet during the fogging process. If the eggs are badly soiled and the bacterial kill rate is low, then the number of rotten eggs in the hatchery will increase. Some chemical disinfectants cause additional problems because they may naturally burn or corrode organic material, causing significant damage to the cuticle on contact.

Washed Eggs

Washed eggs are not only badly soiled, but also immersed in water which may be heavily contaminated. Ideally, any egg that is soiled enough to need washing should not be used as a hatching egg. If hatching eggs must be washed, the water used should be 7-10°C (12.6-18.0°F) warmer than the eggs, so that the egg contents do not cool too quickly. Sudden cooling causes egg contents to shrink, pulling contaminated water into the egg through the pores. **Figure 89** shows contamination on the inside of a washed egg which had been stored for 10 days.

Figure 89
Color change on the inside of the shell of a washed egg shows bacterial contamination inside the egg.

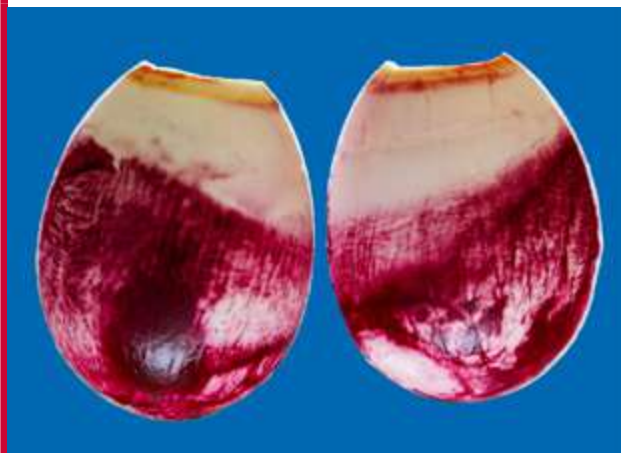

Floor Eggs

Floor eggs are laid onto a contaminated surface and are often allowed to cool there, which increases the rate of bacterial penetration of the eggshell. If the litter is wet, then the bacterial penetration will be worse; that is why floor and soiled eggs can be a major source of contamination and rotten eggs (bangers). Information on managing the flock to minimize floor eggs is covered in the section *Management into Lay*.

If using floor eggs is unavoidable, they should be collected frequently (5 or 6 times per day) and disinfected as soon as possible so that they are able to cool in a clean environment. Any badly soiled eggs should be discarded. Floor eggs sent to the hatchery should be clearly identified on trays and buggies so that the hatchery can handle them appropriately.

If slightly soiled eggs are buffed or scraped to remove the surface dirt from the shell, it can block the shell pores, damage the protective cuticle and increase the risk of contamination.

Eggshell Disinfection

Eggshell disinfection is important because it limits the transfer of micro-organisms from farm to hatchery, and also reduces the damage caused by bacteria passing through the shells compromised by cuticle damage or condensation. However, it will not affect bacteria already inside the egg. After bacteria enter the egg, they are protected from any disinfection treatment by the egg contents. This is why it is important to keep the nest boxes clean, avoid damaging the cuticle and avoid situations where condensation might form on the egg surface (**Table 22**).

Formaldehyde is effective against bacteria, viruses and fungal spores, does not damage the inactive blastoderm and has a residual effect which continues to protect the egg after the initial treatment. It does not damage the cuticle, and is inexpensive and straightforward to use. However, formaldehyde is a carcinogen and its application is restricted or prohibited in many countries.

Because of the reduced use of formaldehyde worldwide, alternative hatching egg disinfection chemicals and application methods are often suggested and should meet the following conditions:

Kills bacteria and fungi, in active and sporulated forms, after a single application, which does not slow down the process of packing the eggs.

Is safe for humans without the use of personal protective equipment.

Dispersed in gas form – not dissolved in water.

Causes no physical damage to the cuticle.

Allows the farm to treat eggs after each collection, rather than at the end of the day.

A good alternative to formaldehyde is the use of ultra violet (UV) light above the egg collection belt before the eggs are packed. This provides a good bacterial kill without damaging the cuticle, is associated with slightly improved hatchability and improves the hygiene status of the egg collection belt.

Egg Collection

Aspects of nest and floor egg management will influence the opportunities for eggs to become contaminated, and also how smoothly they cool down and stay cool. Important nest management factors include:

Keep nests free of droppings and other sources of contamination by daily inspection and removal of loose droppings, and by washing nests in accordance with cleaning and disinfection protocols.

Collect eggs frequently to reduce the chances of eggs being cracked and dirty at collection, and also improve the uniformity of cooling.

Figure 90 shows a thermal image of egg temperatures at the time of collection in a house with automatic nests and an automatic packer, where eggs were collected twice daily. When eggs sit on the belt for an extended period and the environmental temperature is warm, eggs can be pre-incubated, and thus reduce overall hatchability.

Collect final daily eggs as late in the day as possible to minimize the number of eggs held in the nests or belts overnight.

Check any area of transition on the egg belt to ensure the belt is level and there are no rough areas or obstructions in the path of the eggs.

Figure 90
The range of egg temperatures at a collection in an automatic nest system.

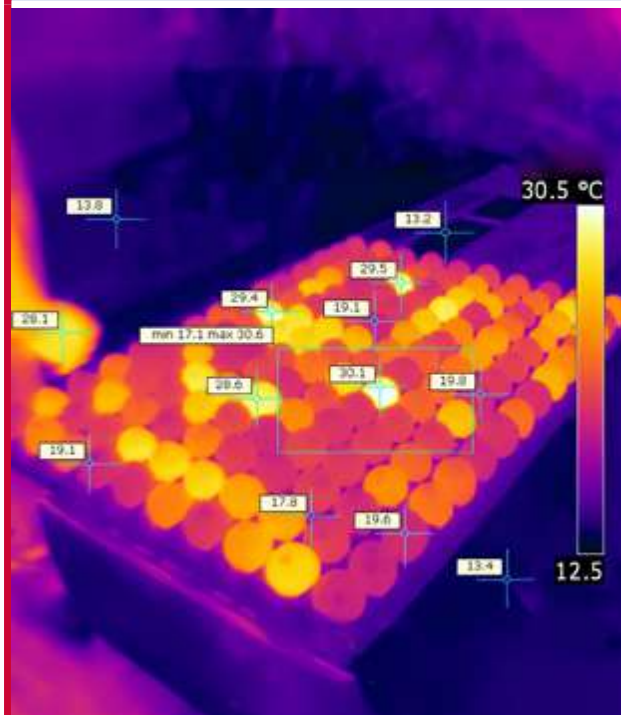

Egg Selection and Packing

Reject small eggs (minimum egg weights will vary), cracked or damaged eggs, eggs with gross shell abnormalities, double-yolk eggs, soft-shelled eggs and any eggs that are more than 25% covered with dirt or droppings (or exceed levels of soiling stipulated by hatchery or regulatory requirements). Record numbers rejected in each category and monitor them.

Packing should allow eggs to be cooled evenly and moved freely. The easiest way to achieve this is to pack eggs onto setter trays which are then placed on farm trolleys, stacking bottom to top so that warm eggs are not rewarming eggs from an earlier collection (**Figure 91**).

In certain situations, it may be necessary to pack eggs on fiber trays into cardboard boxes for storage and transport; eggs must be allowed to cool on well separated racks before they are packed.

Avoid wrapping eggs in plastic wrap, as it will encourage contamination. If there is no alternative, allow the eggs to cool before wrapping and remove the plastic immediately after transport.

Once an egg trolley has been placed in the egg store, it should stay there. Fill a partial trolley by taking trays of eggs into the store to finish loading, not by taking the trolley out of the store.

Figure 91
Eggs packed incorrectly from top to bottom, placing warm eggs below those that are already cooled.

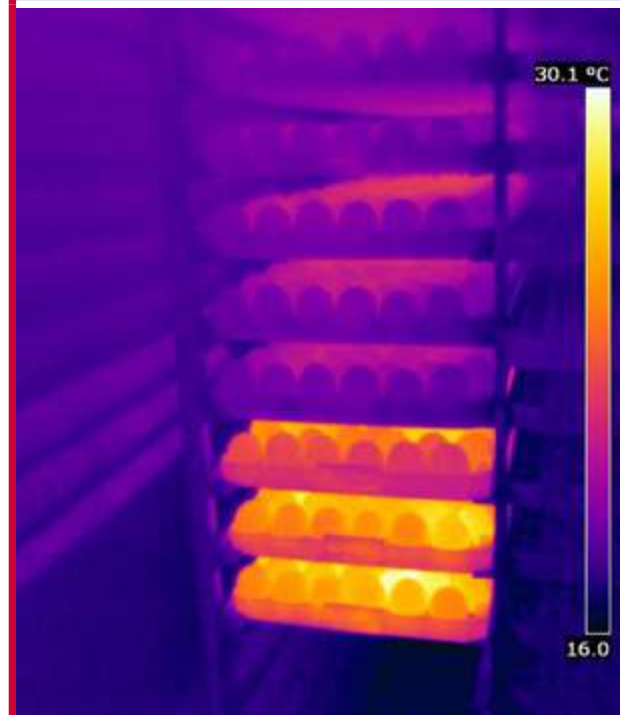



Egg Cooling and Storage

Once the egg is laid, it should be cooled to a point when embryo development stops. Slow cooling is usually associated with better hatchability, but the cooling rate on an individual farm will be driven by the ambient temperature in the egg packing room, which depends on the local climate.

Embryo growth and development completely stops at 15°C (59.0°F). Any temperature above 15°C (59.0°F) will allow at least some development, and egg storage longer than 7 days will start to damage hatchability. Egg storage conditions should be optimized to maintain hatchability.

Farm egg stores should be insulated and cooled to maintain a constant 15°C (59.0°F) (**Table 23**). If egg age is kept below 4 days, then storage at 18°C (64.4°F) is unlikely to be a problem; if egg ages regularly exceed 15 days, 12°C (53.6°F) can work well, but only if great care is taken to avoid condensation when eggs are moved to a warmer environment. On farm storage temperatures should be monitored so that the temperatures are adjusted when the average storage duration changes.

It is important to coordinate temperatures with those used in transport to, and storage at, the hatchery. This will avoid fluctuating temperatures and condensation.

Ideally, egg store humidity should be held between 70 and 80% RH to prevent the eggs from losing too much moisture during storage.

Airflow in the egg store should be uniform throughout the room. Do not blow cooler or heater fans towards eggs. Trolleys should be laid out separately; do not block the airflow.

Hygiene of the egg store should be carefully monitored. The clean and disinfection procedure should be audited regularly.

Table 23
Relationship between length of egg storage and temperature of egg store.

Storage Period (days)	Temperature of Storage °C (°F)
1-3	18 (64)
1-7	15 (59)
>7	15 (59)
*>15	12 (54)

*For storage over 15 days, 12°C (54°F) can work well, but only if great care is taken to avoid condensation when eggs are moved to a warmer environment.

Hatching Egg Transport

Eggs can be packed on setter trays and cooled on spaced racks on farm trolleys. The trolleys can be moved to the egg truck and transported to the hatchery by transport vehicle. Moving eggs on setter trays works well with suitable vehicles and when the roads are in good condition. However, if road conditions are poor, excessive jolting increases the number of hairline cracks in the eggshells, and also increases the number of embryos and chicks presenting developmental abnormalities (specifically in doubling of body parts).

Farm Checklist

Avoid Contamination

Keep nest boxes free of droppings, and collect eggs at least 4 times per day, adjusting timings so that no more than 30% of the eggs fall in any one collection. This will limit the incidence of hairline cracks and dirty eggs, and also ensure that no eggs are left on the collection belt for too long.

Collect soiled and floor eggs separately and more often than nest eggs, and then discard. If using them is unavoidable, label clearly and give regular changes of wash water. Take care with washing temperatures as they must be 7-10 °C (12.6-18.0°F) warmer than the warmest eggs.

Avoid buffing or scraping to remove the surface dirt from the shell.

Disinfect with UV light, backing up with formaldehyde (where allowed) on arrival at the hatchery. Avoid egg disinfection methods that wet the eggs.

Manage room temperature and humidity to avoid condensation.

Avoid wrapping eggs in plastic wrap before transport. If wrapping eggs is unavoidable, cool the eggs before wrapping, and remove the plastic wrap immediately after transport.

Manage Embryo Development

Collect eggs frequently to minimize the variability in embryo stage.

Allow eggs to cool naturally – do not pack in boxes or close stacks of plastic trays without cooling eggs first.

Pack trolleys from bottom to top.

Store eggs at 15C (59.0F) once cooled after collection. Adjust temperatures when the average storage duration changes.

Keep trolleys in the egg store. Take trays to partially filled trolleys rather than the trolleys to the trays.

i OTHER USEFUL INFORMATION AVAILABLE



Aviagen Poster: What is a Good Quality Hatching Egg?



Aviagen Poster: Egg Handling from Nest to Setter



Broiler Breeder Management How To: Manage Automatic and Manual Nest and Egg Belts



Best Practice in the Breeder House: Preventing Floor Eggs

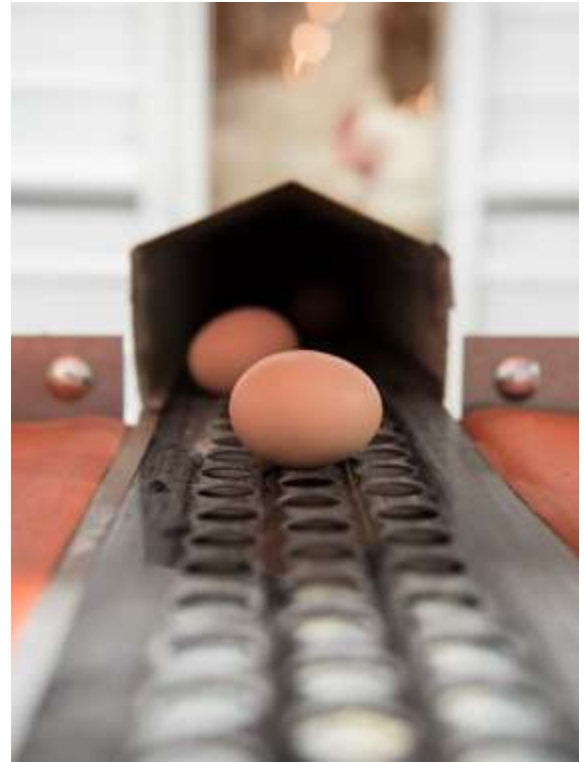



Notes

A series of horizontal dotted lines for taking notes, spanning the width of the page.

Section 7: Environmental Requirements

Housing

Objective

To provide a protected environment in which temperature, humidity, ventilation, daylength and light intensity can be controlled and optimized for the lifetime of the flock in order to achieve good reproductive performance without compromising health and welfare.

Principles

Farm location and house design must take into consideration climate and management systems.

Farm Location and Design

The location and design of a farm (**Figure 92**) will be affected by a number of factors, not least by local economics and regulations.

Figure 92

Examples of typical farm layouts and locations showing good biosecurity.



Climate

Temperature and humidity ranges experienced in the natural climate will influence which type of housing is most suitable (i.e., open or closed) and the degree of environmental control required.

Local Planning Regulations and Laws

Local planning regulations and laws may stipulate important constraints in design (e.g., height, color, materials), and should be consulted at the earliest opportunity. Local law may also dictate a minimum distance from existing farms.

Biosecurity

The size, relative situation and design of houses should minimize the transmission of pathogens between and within flocks. A policy of single- (as opposed to multi-) aged sites is preferable. House design must facilitate effective cleaning-out procedures between flocks (see section on *Health and Biosecurity*).

Access

The farm location must allow for easy access to the site perimeter by heavy vehicles such as feed and egg trucks (i.e., road widths and turning circles must be appropriate for the vehicles servicing the farm).

Local Topography and Prevailing Winds

These natural features have particular importance for open-sided housing. They can be exploited to minimize the entry of direct sunlight and for optimal ventilation or cooling. Open-sided houses should be positioned so that the length of the house is oriented in an east/west direction to minimize solar heat gain through the side wall. The existence of sites nearby, which present an airborne disease risk, must also be taken into account. It is best to build a farm in an isolated area at least 3.2 km (2 miles) from the nearest poultry or other livestock facility that may contaminate the farm.

Figure 93
Example of a back-up generator.



Power Availability and Costs

All poultry houses require a reliable source of power to operate electrical ventilation, heating, lighting and feeding equipment. It is essential to have a back-up system/generator (**Figure 93**) and an appropriate alarm system installed in case of power failure.

Water

A clean and fresh supply of water is required. For more information on maximum acceptable concentrations of minerals and bacteria in the water supply, see the *Health and Biosecurity* section.

Drainage

Farm design features should allow for the separate disposals of rainwater and house cleanout water. This separation is a necessary part of biosecurity and environmental protection. Please refer to local legislation regarding the correct water disposal procedures.

✓ KEY POINTS

Farm design will depend on location, climate and local planning regulations.

Farm location checklist:

- Availability of power and water.
- Local topography and prevailing winds.
- Access.
- Biosecurity.

House Design

Controlled-environment Housing

Controlled-environment (blackout) housing is preferred over open-sided housing, in particular during rear, since it limits variation due to environmental influences, permits greater control over daylength, facilitates control of maturity and body weight and assists in the production of uniform flocks.

Fire Prevention/Control

House design should be planned in such a way to minimize fire risk.

Size and Number of Houses

In determining the size and number of both rear and laying houses, the following should be considered:

The number of eggs required per week.
The number of birds required to achieve the targeted level of production.
The floor area required for the number of birds at the recommended stocking density.
The pattern of egg production throughout lay.
The time required for house cleaning and disinfection.
The preferred/optimum individual house size, determined by the need to maintain the birds in an appropriate environment by managing the ventilation within the house effectively.
The number of houses that the site can accommodate.
The house type.

Stocking Density

Stocking density will depend on local welfare legislation, climate, equipment and local economics. Recommended stocking densities can be found in the sections on *Rearing* and *Management into Lay*.

House Size

The house size selected must enable all of the daily feed allowance to be distributed evenly and be accessible to all birds within a maximum of 3 minutes. This condition should be met for each pen/population within the house.

Lighting

Light should be uniformly distributed throughout the house. Light intensities and durations must achieve recommendations (see section on *Lighting*). Both should be controllable and adjustable. A light meter can be used to measure light intensity across the house at bird height.

Light Proofing

Ventilation system design should include appropriate provisions for light proofing. Effective light traps should be fitted to all air inlets as well as fans. Light proofing is restrictive to air flow, and incorrectly designed/sized light proofing can be detrimental to the performance of the ventilation system and, hence, to the well-being of the birds.

Light intensity should not exceed 0.4 lux (0.04 fc) during the dark period (see section on *Lighting*). This light intensity must be achievable at all stages of ventilation system operation.

Insulation

Insulation aids the effective operation of the ventilation system. The amount of insulation required will depend largely on the local ambient conditions in summer and winter and is subject to local legislation.

Air Tightness

Most modern housing utilizes negative pressure ventilation. In order for the ventilation system to work effectively, the house must be well sealed to prevent any uncontrolled air leaks into the house (i.e., the house must be airtight). Consider air tightness during the design and construction of the house. In particular, give care to the tunnel ventilation inlet, as this is often the area of the house that has the most air leakage.

Ambient Conditions

The local ambient climatic conditions will determine the type and size of the ventilation system required in order to maintain acceptable house conditions for the birds (see section on *Ventilation* for more details).

Heating

In most climates around the world, a heating system is required to keep the house at the desired set-point temperature in the colder months, especially during the rearing stages. Examples of different types of heating equipment are shown in **Figure 94**. The actual heating equipment required will depend on local climate, house design and local fuel availability.

Figure 94
Examples of different house heating systems (from top to bottom, canopy brooder, whole-house heating and space heater).



The heating system should provide enough capacity to maintain the desired house temperature in the colder periods while allowing minimum ventilation requirements to be satisfied. Heat must be evenly distributed throughout the house and should be operated in combination with the main ventilation control system.

Heating systems

Heating systems can be separated into direct and indirect heater types. Direct-fired heaters force air directly through the flame of the heater. Although this is a very efficient way to heat cold air, it increases moisture, CO₂ and CO in the heated environment. When pre-heating or heating a house with direct-fired heaters, running a minimum ventilation rate to exchange the air and prevent the build-up of harmful products in the house is essential. A recommended ventilation rate from the manufacturer will be displayed on the heater; this is the minimum ventilation rate that should be used when pre-heating the house.

Radiant heaters can also be classified as direct-fired heating. Radiant heaters use a flame to heat ceramic components that radiate the heat down onto the house floor. This is very useful during the brooding period, when it is important to maintain a warm bedding temperature.

Indirect heaters flow heated air through a chamber known as a heat exchanger. This process heats the structure of the heat exchanger. The house air, moisture, CO₂, and CO are vented outside via a chimney or duct. The cold air enters the house, passes over or around the heat exchanger's outer surface, and is heated. This method of heating is less efficient than direct heating.

Regardless of which heating system is used, it is important to have a good distribution of heat throughout the bird area of the house. The main ventilation controller should control heaters. The temperature at which they will turn on and off should be carefully set based on bird age and to ensure there is no conflict between the operation of the heaters and the fans.

Biosecurity (see *Health and Biosecurity*)

In designing the structure of the house:

Use materials that provide easily cleanable surfaces.

Smooth concrete floors are easier to wash and disinfect.

Keep an area of concrete or gravel extending to a width of 1-3 m (3-10 ft) free of vegetation around the house, as this will discourage entry of rodents.

Make sure the house is proofed against access by wild birds.

In designing the layout of the farm:

Provide shower facilities for staff and visitors entering and leaving the farm.

If vehicles are to enter the farm (which is not desirable), then a spray booth or equivalent should be available to disinfect the vehicle.

Locate feed bins along the fence line so that feed trucks do not need to enter the farm.

✓ KEY POINTS

House design checklist:

- Environmental management type (controlled/natural).
- Egg requirements, bird numbers and stocking density.
- Lighting and light proofing.
- Insulation.
- Heating.
- Biosecurity.
- Ventilation.

Ventilation

Objective

To ensure that good welfare and reproductive performance are achieved by maintaining birds under appropriate, and where possible, optimal environmental conditions.

Principles

The ventilation system is a tool that should be used to create an in-house environment that will optimize bird comfort, achieve the best biological performance and ensure good bird health and welfare conditions.

It supplies adequate fresh air and also removes excess moisture, gases and airborne by-products. It also contributes to temperature and humidity control in ambient conditions, and provides more uniform house conditions than open housing. Monitoring bird behavior is an essential part of managing the ventilation system.

One of the main objectives of ventilating a house is to ensure bird comfort. Over and above thermometer/sensor readings, visible bird comfort and behavior are the best indicators of how well the ventilation system is being operated.

Ideally, the entire ventilation system should be automated to provide the best environment for the birds year round.

OTHER USEFUL INFORMATION AVAILABLE



Ventilation How To: Calibrate an In-House Fluid Filled Pressure Meter



Ventilation How To: Measure House Air Tightness



Ventilation How To: Measure Fan Capacity



Ventilation How To: Check Air Inlets are Opened Correctly for Minimum Ventilation



Environmental Management in the Broiler Breeder Rearing House



Environmental Management in the Broiler Breeder Laying House



Essential Ventilation Management

Air

The main contaminants of air within the house environment are dust, ammonia, carbon dioxide, carbon monoxide and excess water vapor (**Table 24**). Levels of these contaminants must be kept within legal limits at all times. Continued and excessive exposure to these contaminants can:

- Damage the respiratory tract.
- Decrease the efficiency of respiration.
- Trigger disease (e.g., ascites or chronic respiratory disease).
- Affect temperature regulation.
- Contribute to poor litter quality.
- Reduce bird performance.

Table 24
Effects of common parent stock house air contaminants.

Ammonia	<p>Ideal level <10 ppm.</p> <p>Can be detected by smell at 20 ppm or above.</p> <p>>10 ppm will damage lung surface.</p> <p>>20 ppm will increase susceptibility to respiratory diseases.</p> <p>>25 ppm may reduce growth rate depending upon temperature and age.</p>
Carbon Dioxide	<p>Ideal level <3,000 ppm.</p> <p>>3,500 ppm causes ascites. Carbon dioxide is fatal at high levels</p>
Carbon Monoxide	<p>Ideal level <10 ppm.</p> <p>>50 ppm affects bird health. Carbon monoxide is fatal at high levels.</p>
Dust	<p>Damage to respiratory tract lining and increased susceptibility to disease. Dust levels within the house should be kept to a minimum.</p>
Humidity	<p>Ideal level 50-60% after brooding.</p> <p>Effects vary with temperature. At >29°C (84.2°F) and >70% A RH, 50%, particularly during brooding, will affect performance.</p>

Housing and Ventilation Systems

There are two basic types of ventilation systems:

Natural Ventilation

Also known as open-sided, curtain-sided or natural houses.

Fans may be used inside the house to circulate and move air.

Power Ventilation (Controlled/Closed Environment Housing)

These houses usually have either solid sidewalls or curtains that are kept closed during house operation.

Fans and inlets are used to ventilate the house.

Open-Sided/Natural Ventilation

Open-sided (or naturally ventilated) houses rely on the free flow of air through the house for ventilation (**Figure 95**). Achieving adequate control of the in-house environment can be difficult in open-sided houses, and as a result, consistency and level of performance tends to be lower than in controlled-environment houses. However, adequate heating equipment in natural ventilation houses will be helpful for temperature control.

Figure 95
Example of typical open-sided housing.



Air flow in open-sided houses is controlled by varying curtain opening. Curtains should be fastened to the side wall at the bottom and be opened from the top down as to minimize wind or drafts blowing directly onto the birds.

If wind is coming consistently from one side of the building, the curtain on the side of the prevailing wind should be opened less than the downwind side to minimize drafts on the birds.

Recirculation fans can be used to supplement natural ventilation and enhance temperature control within the house. Management of the curtains to maintain bird comfort is a 24-hour-a-day job and extremely difficult to get right.

Translucent curtain materials allow the use of natural light during daylight hours. Black curtains are used in situations where it is necessary to exclude daylight (e.g., to provide blackout during rearing). It is important to note that the curtains should not be completely closed due to ventilation restriction.

Achieving adequate ventilation during hot weather can be difficult in open-sided houses. However, several steps can be taken to minimize the impact of hot weather. These include:

Reducing flock stocking density.

Insulating the roof to prevent radiant heat from the sun reaching the birds. In some instances, water can be used to cool the external roof surface. This strategy must be used with caution as runoff from the roof can lead to increases in relative humidity levels inside the house.

Using circulation fans to create air movement over the birds.

Using tunnel ventilation system with evaporative cooling.

Naturally ventilated houses should be constructed to a specified width (i.e., 9-12 m [30-40 ft] and a minimum height to the eaves of 2.5 m [8 ft], to ensure adequate air flow.

When outside conditions are cold, opening the curtains even slightly results in the heavy cold air entering the house and dropping directly down onto the litter and the birds. This cold air causes the birds discomfort and can result in wet litter. At the same time, warmer air escapes from the house, which results in large temperature swings and high heating costs.

In cold weather, internally mounted circulation fans can be used to enhance temperature control within the house by circulating the warm air that has risen and accumulated in the peak of the house. However, care must be taken to ensure that these fans do not create any air movement at bird level. In cool climates, automatic curtain operation is recommended, with circulation fans also operated by timers with thermostat overrides.

During hot weather, unless there is wind blowing, opening the curtains fully may still not provide adequate relief for the birds. Circulation fans can also help in this situation by creating air movement over the birds, giving them some relief through the wind-chill effect.

Circulation fans, if installed, normally hang down the center of the house (**Figure 96**), but installing hot-weather circulation fans near to the sidewall of the house means the fans will draw cooler, fresh (less humid) air from outside the house.

Fans are usually installed to blow air diagonally across the house and should not be installed too close to any solid surface that may restrict air access to the fan.

Figure 96
Circulation fans in an open-sided/naturally ventilated house.



Controlled-Environment Housing

Power ventilation in controlled or closed-environment houses is the most popular form of ventilation system for parent stock due to the ability to provide better control of the internal environment under a range of ambient conditions. The most common form of controlled-environment housing is that which operates under a negative pressure. These houses usually have solid sidewalls and exhaust fans that draw air out of the house and automated inlets through which fresh air is drawn into the house (**Figure 97**).

Figure 97
Example of controlled-environment housing.



In order to provide the best environment for the bird throughout the production cycle and at any time of the year, every closed-environment house should be equipped for the three stages of ventilation. These are:

Minimum ventilation.

Transitional ventilation.

Tunnel ventilation.

In some regions of the world where ambient temperatures do not get hot enough to warrant the need for tunnel ventilation; this stage may be omitted from the design of the house.

Because closed-environment houses usually have solid sidewalls, it is strongly advised to link these houses to standby generators in case of power loss. Standby generators should be checked regularly for correct operation. In power-ventilated, curtain-sided houses, automatic curtain-opening devices should be in place.

“Negative” Pressure

When the fans are switched off, the pressure inside the house will be the same as that outside the house. This means that if the doors or side inlets are opened, the air will not flow into or out of the house (assuming the wind is not blowing).

In a well-sealed, airtight house, when an extraction fan is switched on, air will start to leave the house through the fan and the pressure inside the house will be different than that outside the house. The outside pressure will remain the same as before, but the pressure inside the house will reduce, becoming less than the outside pressure. In ventilation terms, this is referred to as negative pressure. In actual fact, the pressure inside the house is not negative; it is still positive, but less positive than the pressure outside.

When there is negative pressure in the house, air will enter evenly through all the inlets, including the walls

and roof, in order to equalize the pressure, regardless of where the fans are situated (**Figure 98**). The greater the negative pressure (the difference in pressure between outside and inside the house), the faster the speed of air coming in through the inlet.

Negative pressure only works efficiently if the house is effectively sealed. In a house that is effectively sealed against air leaks, all the air entering the house comes in through the desired air inlets and uncontrolled air leakage will be minimized.

To determine how well sealed (or airtight) a house is, close all doors and inlets in the house and switch on one 122 cm (48 in)/127 cm (50 in) fan, or two 91 cm (36 in) fans. The pressure within the house should not measure less than 0.15 inches of water column (37.5 Pa) (**Figure 99**). Pressure can be measured anywhere in the house and should be consistent throughout the house for this test.

Figure 99

A manometer used to monitor air pressure within the house (the reading given is equivalent to 0.15 inches of water column).



KEY POINT

For a negative-pressure system to operate successfully, the house must be airtight.

Figure 98

The effect of a pressure difference from outside to inside the house. Air tries to enter from all sides to equalize the pressure difference.

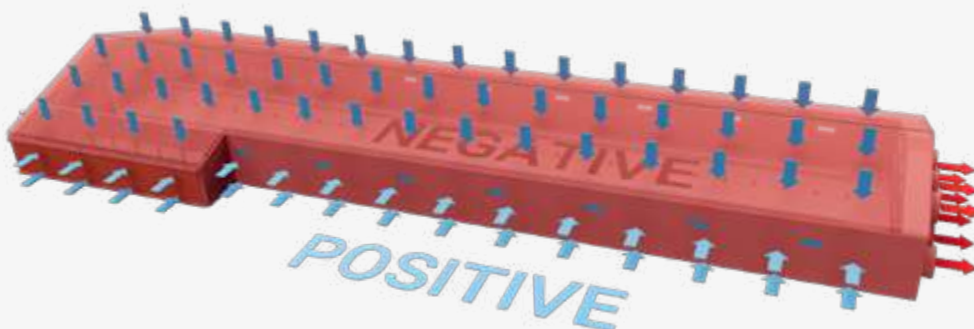

Minimum Ventilation

The minimum ventilation system should operate when the house temperature is below the house set-point temperature (bird comfort temperature), or within 2°C (3.6 °F) above the set-point (dependent on the age of the birds).

Although minimum ventilation is most often associated with the brooding period, it can and should be used any time the condition described above exists.

The minimum ventilation system serves two purposes. One is to provide heat to keep the birds comfortable, and the other is to provide acceptable air quality for the birds. A very important role of the minimum ventilation system while providing acceptable air quality is controlling RH levels inside the house. High RH levels often result in poor and wet litter conditions. Air quality and temperature should be uniform in the entire house during minimum ventilation.

Never sacrifice air quality for house temperature or vice versa. Both should be achieved simultaneously regardless of ambient conditions.

For the successful operation of minimum ventilation, the house must be well sealed to eliminate unwanted air leakage. The house should have adequate, well-distributed heating capacity.

Side wall inlets are used to carefully introduce fresh (cold) air into the house. In order to assist with maintaining the house temperature, the minimum ventilation fans run on a cycle timer (ON/OFF), where the cycle timer ON time is managed to control the air quality and RH levels inside the house.

During minimum-ventilation, the air movement at floor/bird level should not exceed 0.15 m/s (30 cubic feet per minute [fpm]).

Minimum Ventilation Layout

The most common minimum ventilation system consists of numerous sidewall inlets evenly spread along the length of both sides of the house. The inlets are linked to a winch and open and close automatically as determined by the control system. The inlets in use must be evenly distributed in order to supply fresh air equally and evenly throughout the house.

Minimum ventilation exhaust fans are often installed in the sidewall(s) of the house, or sometimes one or more of the tunnel fans are used, although this is not always ideal. The control system operates the minimum ventilation fans on a cycle timer, but often the cycle timer may need to be manually adjusted in order to maintain acceptable air quality in the house.

Heaters should be positioned in order to provide an even distribution of heat throughout the house. Heaters located too far apart can create temperature differences in the house and result in higher heating costs.

Using Tunnel Ventilation for Minimum Ventilation

Some houses do not have side wall inlets and so use the tunnel ventilation system for minimum ventilation. One or more tunnel fans are used on a cycle timer, and all the air enters through the tunnel inlet.

This is not an acceptable minimum-ventilation system and will not be able to provide uniform temperature and air quality throughout the house as is required during minimum ventilation. This is because fresh air enters at one end of the house and is moved slowly, by the cycle timer, down the length of the house of the fans. The colder the outside temperature is, the more difficult it is to manage this layout and the more uneven the house conditions will usually be.

The role of side wall inlets is to distribute the fresh air and heat evenly along the length of the house.

Choosing Minimum Ventilation Inlets

Some important characteristics to look for in an inlet (Figure 100) are:

The inlet should seal well when closed.

The inlet door should be insulated.

It should have a mechanism to lock/keep the door closed when not required to open.

It should have an air direction plate to direct the incoming air, especially if the ceiling of the house has exposed obstructions.

The inlet door should be set into the frame of the inlet and be inclined at an angle when in the closed position.

Figure 100
Example of a good-quality air inlet.



Using Negative Pressure During Minimum Ventilation

Hot air rises and will always accumulate at the highest part of a well-sealed and well-insulated roof. With this in mind, when the cold outside air enters the house, it will travel along (or close to) the ceiling (**Figure 101**). This will keep the cold air away from the birds and allow the outside air to mix with the warm air in that part of the house. As the cold air warms up, the RH of the air will reduce, making it easier for the air to absorb moisture and thereby helping to keep the house and litter dry.

The differential (negative) pressure can control the speed at which the air enters through the inlet. This speed will determine how far the air will carry into the house and along the ceiling before it stops and starts to flow down towards the birds (**Figure 102**). Ideally, controlling the negative pressure inside the house can direct air to travel from each side wall of the house to the middle of the house, or apex of the ceiling.

If the pressure difference is insufficient, the air enters slowly through the inlet and soon drops to the floor inside the house, stressing the birds and possibly causing wet litter. As the negative pressure is increased, the incoming air speed will increase. Negative (differential) pressure can control how far the air will travel into the house.

Figure 101
Using negative pressure to control air speed.

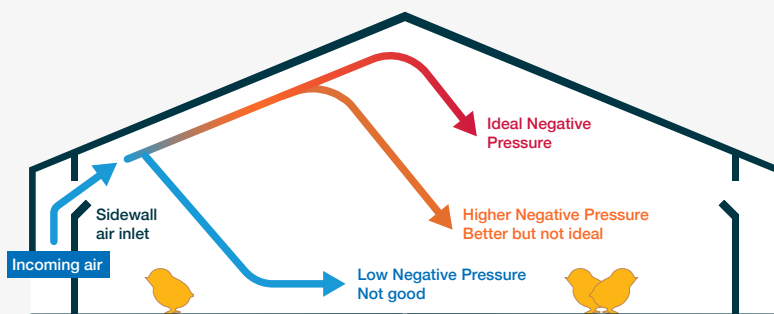
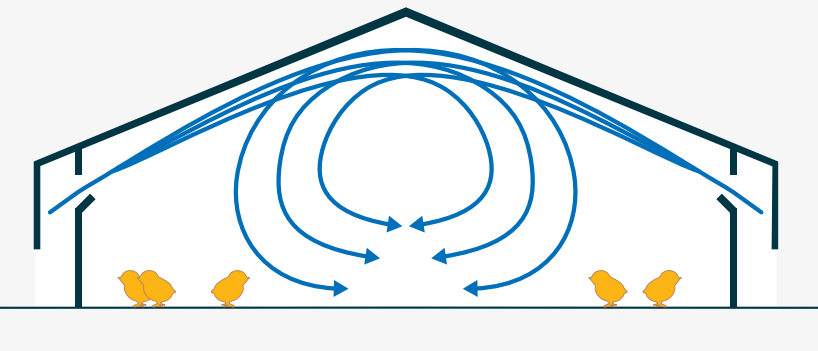

Figure 102
Correct air flow during minimum ventilation.



What is the Correct Operating Pressure for a House?

The negative pressure should create sufficient incoming air speed to throw the incoming air to the middle of the house. The ideal operating negative pressure of a house during minimum ventilation will depend on the following factors:

The width of the house (the distance the air must travel from the side wall to the middle of the ceiling or apex of the ceiling).

The angle of the internal ceiling.

The shape of the internal ceiling (smooth or with obstructions).

The type of inlet used.

The amount the inlet is opened.

The use of light traps on the inlets. If there are light traps on the outside of the side wall inlets, then the house operating pressure is expected to be higher than in a house without light traps (and similar width).

Guidelines exist for the operating pressure of different-width houses, but these will vary based on the factors given above.

Setting Air Inlets

There are 3 requirements to get the best performance from house inlets:

1. The minimum-ventilation inlets should be opened at least 3-5 cm (1.8-2.0 in).

For a given pressure, the more the inlet is opened, air flows better and further into the house. An opening of 3-5 cm (1.8-2.0 in) is recognized as a reasonable guideline. The total number of side inlets in a house is based on the minimum ventilation requirement. Not all the available air inlets will need to be opened at the same size. If air inlets are open too much or too many are opened, negative pressure within the house will be reduced and the speed of entering air will be too slow so that it falls directly on to the birds. As a result, it is common practice to only open every second, third or even fourth inlet during minimum ventilation. The inlets should all open equally from the front to the back of the house, and from the left to the right side.

2. There should be enough negative (differential) pressure.

The differential pressure should create enough air speed to throw the incoming air along the ceiling to the middle of the house, or to the apex of the ceiling.

3. Air direction plate should be adjusted correctly.

Proper adjustment of the air direction plate above the inlet door is important to direct the air to the apex of the roof. This is particularly important if there are roof structure beams or any other potential obstruction to the air flow as it travels to the middle of the house. Therefore, the air direction plate should be set to direct the air parallel to the ceiling and below the obstructions. The direction plates must be carefully and correctly set. A presentation-type laser pointer with a strong red or green laser beam can be used to help determine if the direction plate is set correctly. Hold the pointer on the underside of the air direction plate and see where the laser dot hits the roof or obstruction surface. This will give a good indication of the angle at which the direction plate should be set to avoid obstructions (**Figure 103**).

If the house has a smooth ceiling, a general guideline is to set the air direction plate so that the air makes contact with the ceiling surface ± 0.5 m to 1 m (1.6 to 3.3 ft) away from the sidewall.

Figure 103

Using a presentation laser to determine if the air direction plate is positioned correctly. A simple laser pointer can be used to provide a visual reference of direction of air flow into the house. The direction plate can then be set to ensure that air flow bypasses any ceiling obstructions.

Example 1: Direction plate in wrong position

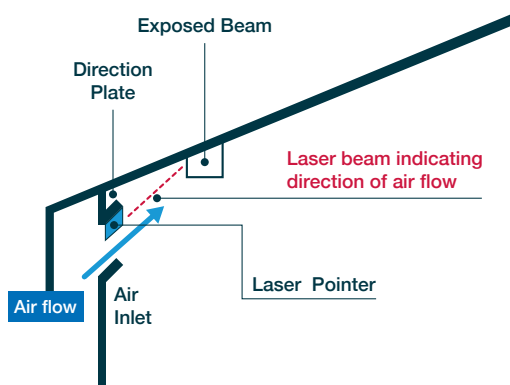

Laser pointer indicates direction plate not in correct position. Air will be deflected by the beam and fall onto birds.

Example 2: Direction plate in correct position

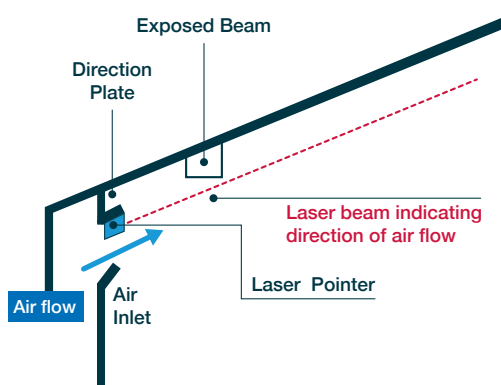

Direction plate in correct position. Laser pointer shows air flow will bypass exposed beam and continue to roof apex.

How to Check Inlet Set-up

Having sealed the house and set the inlets for minimum ventilation, it is important to verify the settings by checking the air flow. Three methods are:

1. The “feeling” test

While the minimum ventilation fans are OFF, stand 2-3 m (6.6-9.8 ft) away and in front of a minimum ventilation inlet. From the time that the cycle timer fan(s) start to run until they switch back off, no cold, incoming air flow should be felt. All air flow should go above head height and along the ceiling (**Figure 104**). If air flow is felt, it may mean that the inlet setting should be adjusted.

2. Smoke test (**Figure 105**)

When smoke-testing a house, it is advisable to do so under worst-case conditions, that is, when the house is at brooding temperature and when the ambient temperature is at, or close to, as cold as it may get. As long as the air inlets being used for minimum ventilation are opened an equal amount, the smoke test can be completed on any inlet. Use a smoke test (outside the house) to show air entry, or turn lights off and stand in dark to see where cracks are. Be aware that some smoke generators emit warm smoke. If testing a house when it is empty and cold inside, the smoke will try to rise to the peak of the house even if the pressure is actually too low.

3. Ribbon tape test

Another test method is to hang strips of ribbon tape about 15 cm (6 in) long from the ceiling every 1-1.5 m (3-5 ft). The first strip is hung ± 1 m (3.3 ft) from the inlet and every other 1-1.5 m (3.3-4.9 ft) apart, with the last strip being at the apex of the ceiling. The strips need only be hung in front of one inlet to give an indication of how all inlets are operating. Using an inlet near to the entrance of the house allows to view the air flow when entering the house. When the fans are on, the tape closest to the inlet should show significant movement and will blow strongly against the ceiling. The movement of the tape should become less as the air moves further away from the inlet. The strip hanging at the apex of the ceiling should move very slightly, indicating that the air has almost come to a stop and is starting to flow down towards the floor. These tapes can remain in place throughout the production cycle and provide a quick visual check when entering the house.

Figure 104

Illustration of air flow into the house. The picture on the top shows a correct air flow during minimum ventilation. The picture on the bottom shows an incorrect air flow during minimum ventilation.

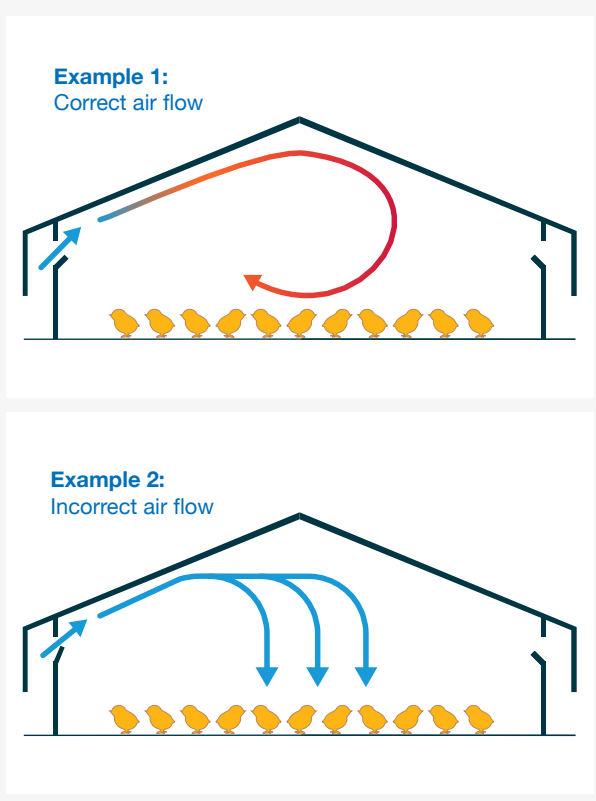

Figure 105

Using a smoke test to determine if air flow and operating pressure are correct.



Minimum Ventilation Rates

A minimum ventilation requirement guideline is shown in **Table 25**. Fully-worked calculations can be found in *Appendix 5*.

Prior to 7 days, the actual air speed at floor level should be no more than 0.15 m/sec (30 ft/min).

Maximum levels of RH, carbon monoxide, carbon dioxide, and ammonia should never be exceeded. Monitor bird behavior and distribution, as this can be an indicator of issues that need to be investigated.

Minimum Ventilation Operation

Minimum ventilation is a period of providing heat to the house, carefully ventilating to provide acceptable air quality for the birds and controlling relative humidity.

To assist with maintaining the house temperature, the fans operate on a cycle timer. Good management of the cycle timer settings determines the air quality and RH in the house.

When the fans run, the sidewall minimum ventilation inlets should open the correct amount to maintain the correct negative pressure and direct the incoming air up to the peak of the roof. At the end of the ON time, the minimum ventilation fans will switch off and the inlets should close.

During minimum ventilation, the heating system should operate any time that the actual house temperature is below the required set-point temperature, even if the minimum ventilation fans are running.

During the early stages of the production cycle, the heating set-point is usually set to activate the heaters in close range to the required house set-point temperature. For example, the heaters may be set to activate at 0.5°C (1°F) below the house set-point temperature and switch back off again slightly below or at the house set-point temperature.

Because there is often more emphasis on adding heat to the house during minimum ventilation and the early stages of the cycle, the fans may be set to only start working continuously if the house temperature exceeds the set-point by 1-1.5°C (2-3°F).

These settings will change as the birds grow older. Typically, the differential between the house set-point temperature and the heating set-point will increase, and the differential between the house set-point temperature and the fan override temperature will decrease.

Table 25
Approximate minimum ventilation rates per bird.

Average weight kg (lbs)	Ventilation rates m ³ / hr (ft ³ /min)
0.05 (0.11)	0.09 (0.05)
0.10 (0.22)	0.15 (0.09)
0.20 (0.44)	0.26 (0.15)
0.30 (0.66)	0.35 (0.21)
0.40 (0.88)	0.43 (0.26)
0.50 (1.10)	0.51 (0.30)
0.60 (1.32)	0.59 (0.35)
0.70 (1.54)	0.66 (0.39)
0.80 (1.76)	0.73 (0.43)
0.90 (1.99)	0.80 (0.47)
1.00 (2.21)	0.86 (0.51)
1.20 (2.65)	0.99 (0.58)
1.40 (3.09)	1.11 (0.65)
1.60 (3.53)	1.23 (0.72)
1.80 (3.97)	1.34 (0.79)
2.00 (4.41)	1.45 (0.86)
2.20 (4.85)	1.56 (0.92)
2.40 (5.29)	1.67 (0.98)
2.60 (5.73)	1.77 (1.04)
2.80 (6.17)	1.87 (1.10)
3.00 (6.62)	1.97 (1.16)
3.20 (7.06)	2.07 (1.22)
3.40 (7.50)	2.16 (1.27)
3.60 (7.94)	2.26 (1.33)
3.80 (8.38)	2.35 (1.39)
4.00 (8.82)	2.44 (1.44)
4.20 (9.26)	2.53 (1.49)
4.40 (9.70)	2.62 (1.55)
4.60 (10.14)	2.71 (1.60)
4.80 (10.58)	2.80 (1.65)
5.00 (11.03)	2.89 (1.70)

This table should only be used as a guideline, as actual rates may need to be adjusted to environmental conditions, bird behavior and bird biomass (total bird weight in the house).

To calculate minimum ventilation requirement, see the example in *Appendix 5*.

Evaluating Minimum Ventilation

Table 25 provides minimum ventilation rates based on bird body weight. The figures given are a guideline only. Their use does not guarantee acceptable air quality or bird comfort. Most often, minimum ventilation is more about controlling RH than providing fresh air for the birds. An increase in house RH is often the first sign of under-ventilating. In other words, if a house is ventilated purely by supplying the theoretical “bird requirements”, the house will often have very high RH levels and possible wet litter. However, if the house is ventilated enough to control the RH levels in the house, there will be more than enough fresh air for the birds.

The best way to evaluate a minimum ventilation rate/setting is by visually assessing bird comfort, behavior and air quality.

When entering the house to evaluate the minimum ventilation rate, try to do so without disturbing the birds. The following should be observed:

Spread/Distribution of the Birds:

Are birds well spread?

Are there specific areas of the house that are being avoided?

Bird Activity:

Look along drinker lines – is there bird activity at the drinkers?

Birds should be drinking and resting. During lay, there should be mating activity and birds using nest boxes.

Are birds sitting, huddling together and showing signs of being cold?

Air Quality:

During the first 30 to 60 seconds of entering the house, ask the following questions:

1. Does it feel stuffy?
2. Is the air quality acceptable?
3. Is humidity too high or too low?
4. Does it feel too cool or too warm in the house?

The use of instruments capable of measuring relative humidity, carbon dioxide, carbon monoxide, and ammonia will allow a proper and quantitative evaluation. For specific air quality recommendations, see **Table 24**.

If any of the observations made indicate that minimum ventilation is not adequate, adjustments must be made to correct this. Try to make an evaluation of the air quality within the first 60 seconds of entering the house and before becoming accustomed to the conditions.

KEY POINTS

It is essential to provide some ventilation to the house, regardless of the outside conditions.

Minimum ventilation should operate when the house temperature is below the house set-point temperature (bird comfort temperature), or within 2°C (3.6 F) above the set-point (dependent on the age of the birds).

Minimum ventilation should be timer-driven.

Not all air inlets need to be opened, but those that are opened should be evenly distributed through the house and open equally. When setting up the minimum ventilation inlets, the minimum air inlet opening size should be around 5 cm (2 in).

Monitor air flow and bird behavior to determine if settings are correct.

Transitional Ventilation

Transitional ventilation is used when the house temperature increases above the desired (or set-point) temperature, but it is not yet warm enough to use tunnel ventilation (see section on *Tunnel Ventilation*). Transitional ventilation is a temperature-driven process. As the house temperature increases above the required set-point, the ventilation system should be set to stop operating minimum ventilation (cycle timer) and start to ventilate continuously for temperature control (transitional ventilation). During transitional ventilation, a large volume of air can be introduced into the house. Because the outside air temperature is still close to the house set-point temperature or a few degrees above, the air enters through side wall inlets and should be directed upward and along the ceiling, as in minimum ventilation.

Transitional ventilation works in a similar way to minimum ventilation. Air inlets operating on the basis of negative pressure direct the incoming air away from the birds up to the apex of the house, where it mixes with warm in-house air before falling back to floor level. The number of sidewall inlets in use is increased from minimum ventilation to allow a higher volume of air to enter the house. The total sidewall inlet capacity (number and size of inlets) determines the amount of air that can enter the house and in turn, the maximum number of fans that can be used. During transitional ventilation, the tunnel inlets must remain closed, and the air should enter only through the side wall inlets.

Therefore, it is important that the house design is correct and there is sufficient inlet area.

If there are too few inlets in the house, it may be necessary to switch to tunnel ventilation earlier than normal to ensure excess heat is removed from the house. However, switching to tunnel ventilation can cause discomfort to the birds as air will be blowing directly onto them. As a general guideline for transitional ventilation, there should be sufficient side inlets to be able to use 40-50% of the tunnel fan capacity without opening the tunnel inlets.

During transitional ventilation, if the temperature continues to increase above the set-point temperature, more fan capacity will be required and after all the sidewall fans are operating continuously, the tunnel fans will also start to operate. It is acceptable to use only tunnel fans, or a combination of side wall and tunnel fans. The tunnel ventilation inlets remain closed; air only enters through the sidewall inlets during transitional ventilation (**Figure 106**).

During transitional ventilation, because large volumes of air may flow into the house for extended periods of time, birds may feel some air movement. Observing bird behavior (the distribution of birds in the house and bird activity) will help to determine if transitional ventilation settings are correct. If birds are seen sitting down and/or huddling, these are signs of them being cold and corrective action should be taken. First, check that the house pressure and the inlet air flow is correct. If it is, switch off the last fan that came on and continue to observe bird behavior. If bird activity improves, continue to monitor the birds for the next 15-20 minutes to be sure there are no further changes in behavior.

The house should be kept in transitional ventilation for as long as possible before switching to tunnel ventilation. The decision to switch to tunnel ventilation should be based on bird behavior (see section on *Bird Behavior in Tunnel Ventilation*).

Figure 106
Typical air movement during transitional ventilation.

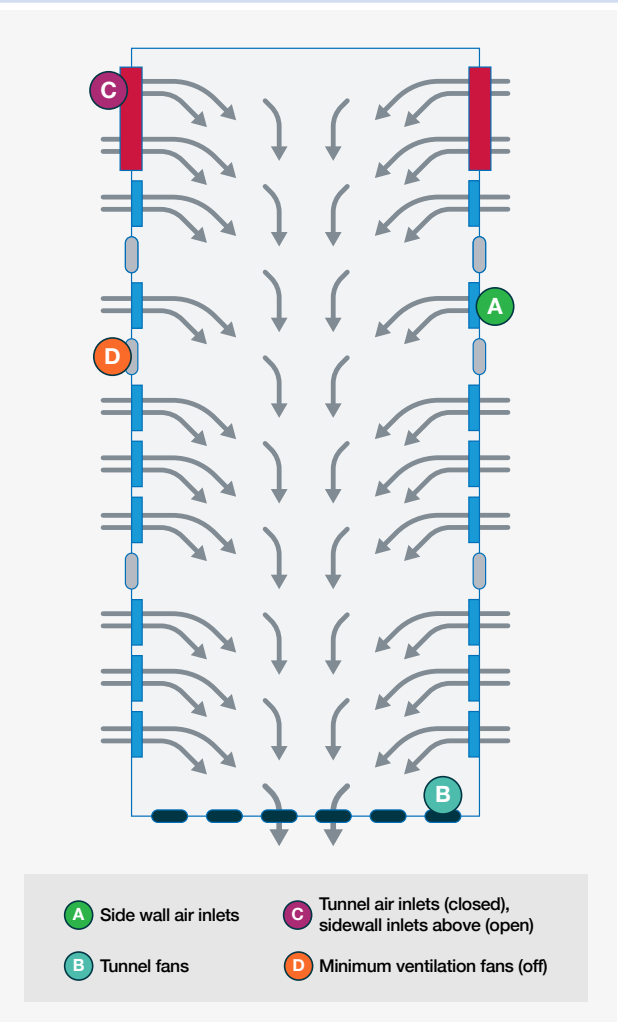

KEY POINTS

- In general, transitional ventilation begins when the house temperature exceeds the minimum ventilation range.
- Transitional ventilation fans start to run continuously to remove heat and air continues to enter through the side wall inlets as in minimum ventilation.
- Side wall and/or tunnel fans can be added to operate as temperature increases.
- As more fans switch ON, more side wall inlet must open.
- Evaluating bird behavior is the only real way to determine if transitional ventilation settings are correct.

Tunnel Ventilation

Tunnel ventilation is used to keep the birds cool. **Figure 107** shows a typical tunnel-ventilated house.

Figure 107
Example of a typical tunnel-ventilated house.



The system uses fans (usually 122 cm [48 in] or larger) at one end of the house and air inlets at the other end. High volumes of air are drawn down the length of the house, creating an air speed along the house and exchanging the air in the house in a short time (**Figure 108**).

The switch from transitional ventilation to tunnel ventilation should occur when the birds need the cooling effect of wind chill. When the maximum transitional ventilation is used but birds are not able to maintain comfort, then it is time to switch to tunnel ventilation. The heat generated by the birds is removed and a wind-chill effect is created that allows the birds to feel a temperature that is lower than that shown on the thermometer or temperature probe/sensor. For any given wind speed, younger birds that are not fully feathered will feel a greater wind chill than older birds and so are more prone to wind-chill effects.

Figure 108
Air flow in a tunnel ventilated house.

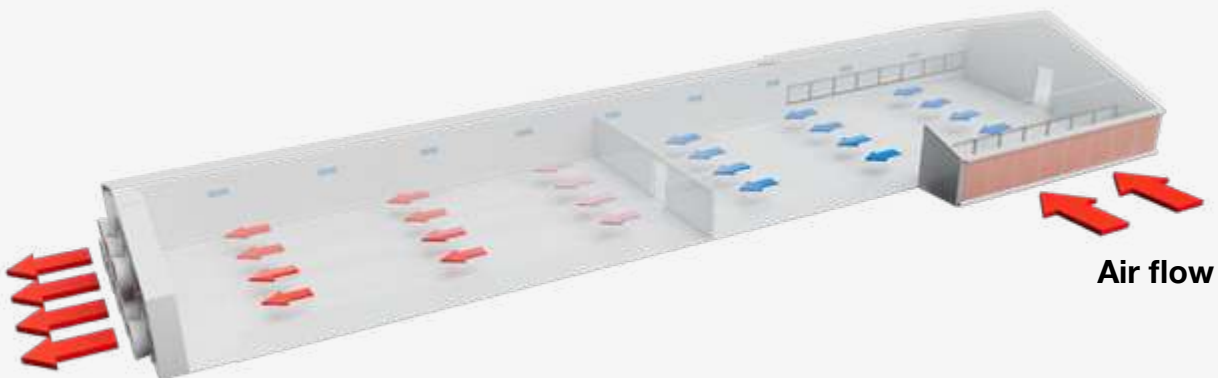

When using tunnel ventilation for cooling, birds will tend to move (migrate) towards the cooler, inlet end of the house, resulting in crowding. If the breeder house is not routinely divided into pens (which will prevent migration), the addition of migration partitions should be considered.

Wind-Chill Effect

Wind chill is the cooling effect felt by the birds any time there is air flow or movement on them. The actual cooling effect that the birds feel is the result of the combination of a number of factors:

The age and feather condition of the bird – the younger the bird, the greater the cooling effect.

The feather condition of the bird – the poorer the feather condition, the greater the cooling effect.

The air speed – the higher the air speed, the greater the cooling effect.

The air temperature (dry bulb temperature) – the higher the temperature, the lower the cooling effect.

Relative humidity (RH) – the higher the RH, the lower the cooling effect.

Stocking density – the higher the stocking density, the lower the cooling effect.

The actual temperature felt by the birds during tunnel ventilation is known as the effective temperature. Effective temperature cannot be measured by a thermometer or temperature probe/sensor. As such, during tunnel ventilation, the readings taken by the thermometer or temperature probe are of limited use in determining the temperature that the bird may be feeling.

Bird Behavior in Tunnel Ventilation

Monitoring and evaluating bird behavior are the only real ways to determine if tunnel ventilation settings are correct for the age, stocking density, biomass and feather cover of the flock. The effects of wind chill on a flock cannot be clearly defined using temperature and humidity meters only. During tunnel ventilation, regardless of what the house thermometer shows, birds could be feeling a temperature different to what is indicated on the sensors. Use extreme caution when using tunnel ventilation with younger birds as the wind-chill effect will be much higher.

If birds are sitting down and huddling, they may be feeling cold. If birds are spread out, but with wings held slightly away from their bodies, or if they are lying on one side with one wing open, they may be too warm. If more than 10% of birds are panting slightly or heavily, the flock may be too warm. These signs may indicate a change to ventilation settings is necessary.

During lay, drops in egg production may be due to extremes in temperature from incorrect tunnel ventilation management. If birds are too cool for example, energy will be used to keep them warm rather than for egg production. If birds are too warm, feed intake will reduce and more energy will be expended for increased respiration, and egg production will drop.

Floor eggs may increase if air speed is too high causing drafts in nest boxes, as birds will prefer to lay eggs on the floor where the air speed is usually slower.

Tunnel ventilation settings should be checked and adjusted if birds are exhibiting any of the above behaviors. Depending on the behavior of the birds, this can be achieved by:

Reducing or increasing the number of fans in use.

Turning evaporative cooling systems on or off (fogging or pads).

Increasing air speed by the use of in-house baffles to increase wind-chill effect.

Increasing or reducing the amount of time that evaporative cooling pad pumps are running.

A fully-worked example calculation to determine the number of fans required for tunnel ventilation can be found in *Appendix 5*.



KEY POINTS

Tunnel ventilation cools birds by creating air flow.

Tunnel ventilation controls the effective temperature felt by the bird which can only be estimated by bird behavior.

Younger or poorly feathered birds feel a greater wind chill than older or fully feathered birds for a given air speed, and thus are prone to wind-chill effects.

Monitoring bird behavior is critical.

Evaporative Cooling Systems

Evaporative cooling is the cooling of air through the evaporation of water. It can improve environmental conditions in hot weather and enhance tunnel ventilation. As a guideline, evaporative cooling should only be used when the birds' behavior indicates that the wind-chill effect on its own is no longer keeping the birds comfortable. Ideally, evaporative cooling is used to hold the house temperature at the level where the birds were last comfortable with all the tunnel fans operating. The purpose of evaporative cooling is not to reduce the house temperature back down to (or even close to) the set-point temperature of the house.

The amount of evaporative cooling that can take place depends on the RH of the ambient external environment.

The lower the RH of the air, the greater the amount of moisture that it can accept and so the greater the amount of evaporative cooling that can take place.

The higher the RH, the less the evaporative cooling potential of the air.

Consider a wet and dry bulb thermometer. The dry bulb shows the actual air temperature. The temperature shown by the wet bulb is the lowest temperature that can be achieved using evaporative cooling, assuming that the cooling system is 100% efficient. In general, cooling pads are only $\pm 70-85\%$ efficient.

At any given time, the difference between dry bulb and wet bulb temperatures will give an indication of the maximum evaporative cooling that could take place assuming that evaporative cooling is 100% efficient (**Figure 109**). In reality, the actual temperature reduction able to be achieved will be closer to 70-85% of the difference between dry and wet bulb temperatures.

There are two main types of evaporative cooling: pad cooling and spray cooling.

Figure 109

Maximum cooling possible during evaporative cooling is about 75% of the difference between dry and wet bulb temperature.

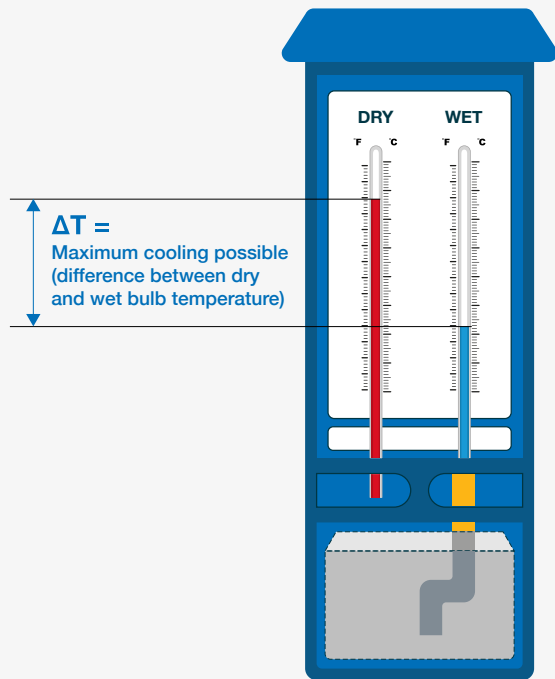

Pad Cooling

In pad cooling systems, air is drawn through a wet cooling pad by the tunnel ventilation fans (**Figure 110** and **Figure 111**). This design and layout of the cooling pads allow the large volumes of air used in tunnel ventilation to enter through the pad surface area and be cooled before entering the house.

Figure 110

Example of a cooling pad.



Figure 111
Pad cooling with tunnel ventilation.

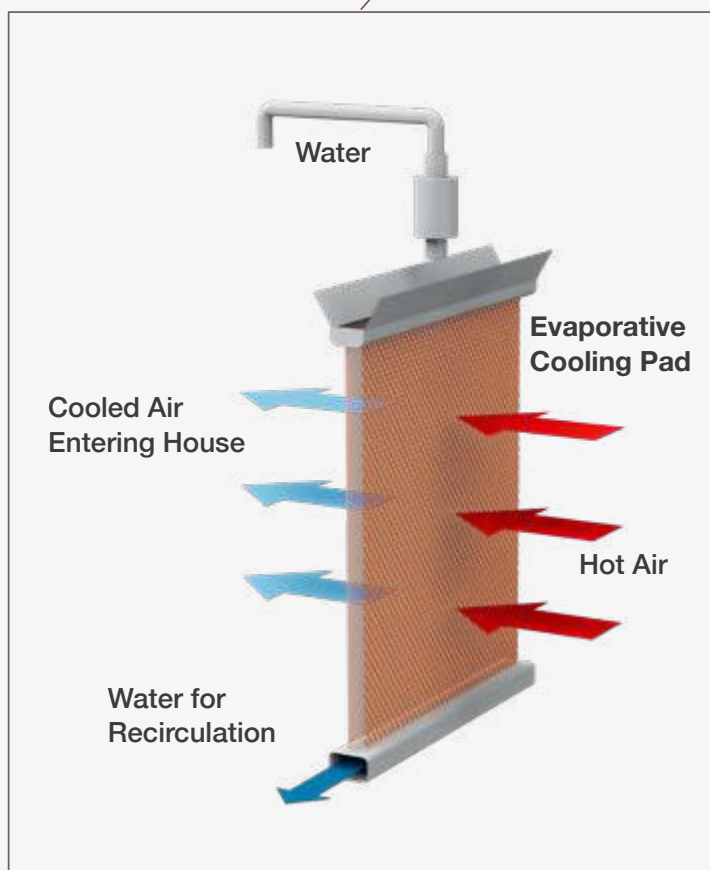

A full worked example calculation of cooling pad area is given in *Appendix 5*.

Because evaporative cooling adds moisture to the air and increases relative humidity, it is recommended that evaporative cooling be switched off when the relative humidity in the house exceeds 70-80% (see information on page 118).

Operating Cooling Pads

The use of cooling pads must be managed correctly to ensure birds do not become chilled. The degree of cooling that can be achieved with pad cooling will depend upon the ambient relative humidity in the environment.

During evaporative cooling, water is distributed onto the cooling pads by water pumps. When the pumps first start operating, care must be taken to control the amount of water added onto the cooling pads. Too much water on the pads initially may cause the house temperature to reduce rapidly. This temperature reduction in turn will cause fans to switch off (if automated), changing the wind-chill effect on the birds and the environmental conditions from one end of the house to the other. Ultimately, this change affects bird comfort and health.

Allowing the cooling pump to switch on and off based only on the house temperature can result in large fluctuations in the house temperature. This is because when cooling starts, the pump will run until the house temperature decreases to the OFF temperature. By this time the cooling pads will already be wet, and although the pump has switched OFF, the already wet pads will continue to provide cooling to the incoming air.

Operating the cooling pumps in this way can cause house temperature to fluctuate by 4-6°C (7-11°F) and sometimes more.

Better temperature can be achieved by cycling the cooling pump on and off, which will limit the amount of water going onto the pads initially and allow better control of the temperature. If the house temperature continues to increase, then the controller should be capable of automatically adjusting the ON period of the pump to put more water onto the pad, thus trying to maintain the required temperature rather than create a large reduction in the house temperature. In general, these adjustments cannot be managed manually.

Water quality can have a significant effect on cool pad functionality. Hard water containing high concentrations of calcium can reduce the operating life of the cool pad.

Figure 112
Example fogging system for a cross-ventilated house.



Fogging/Misting

Fogging systems cool incoming air by evaporation of water created by pumping water through spray/fogger nozzles (**Figure 112**). Fogging lines must be placed near the air inlets to maximize the speed of evaporation and additional lines should be added throughout the house.

There are three types of fogging systems:

Low pressure, 7-14 bar; droplet size up to 30 microns.

High pressure, 28-41 bar; droplet size 10-15 microns.

Ultra high-pressure (misting), 48-69 bar; droplet size 5 microns.

A low-pressure system provides the least amount of cooling, and due to the larger droplet size, there is a greater chance of the droplets not evaporating and causing wet litter. These systems are not recommended for use in areas of high RH.

The ultra high-pressure system will create the most cooling and has the lowest risk of wetting the litter.

The number of nozzles and total amount of water introduced should be based on the maximum tunnel fan capacity.

Bird Heat Loss

There are two methods by which birds are able to lose heat, sensible heat loss (SHL) and latent heat loss (LHL) (**Figure 113**).

The first method is SHL (**Figure 113**, green line). When the house temperature is at or close to the recommended set-point temperature, birds appear to be comfortable. This is because the difference between the body temperature of the bird and the air temperature is large enough that the bird is capable of losing heat from its warm body to the cooler air around it. When air temperature is “cool” (left side), most of the heat loss comes from SHL. The bird will not be panting at this time.

As the house temperature increases, the difference in temperature between the bird’s body and the air decreases, so the bird’s ability to lose heat through SHL decreases. As the air gets warmer and the difference becomes smaller, each cubic meter of air can remove less heat from the bird. Therefore, the need to increase the air speed to get more flow of air through the house and over the birds becomes larger.

Eventually, if the air temperature continues to increase, the bird will not be able to lose enough heat through SHL. This is when birds start to pant. When birds start to pant, they use their own internal evaporative cooling system by evaporating moisture from the respiratory system as they breathe (pant) to help lose heat. This method is known as LHL (**Figure 113**, blue line).

As the air in the house gets hotter, panting will become faster. This is an indication that the heat loss to the air (SHL) is decreasing and the heat loss by internal evaporative cooling (LHL) is increasing. By 27°C (80.6°F), LHL becomes the dominant method of heat loss for the bird.

Because LHL involves the evaporation of moisture from the respiratory system of the bird, it is important to try to minimize the RH in the house as much as possible in the given ambient climate.

When the outside conditions are hot and humid, the two main methods of minimizing RH inside the house are by creating high air speed over the birds (exchanging the air in the house as fast as possible) and switching off the cooling pad system. The higher the outside RH, the lower the cooling potential, but RH will become higher and limit the birds’ ability to lose heat. For example, if running the cooling pads when the outside RH is above 80%, the air leaving the cooling pad will probably be less than 2°C (3.6°F) cooler, and the RH will be in the mid to upper 90%, making it extremely difficult for the bird to release heat.

High air speed and a short air exchange time are critical in hot and humid climates.

An evaporative cooling system should always operate based on a combination of temperature and RH, and never based purely on temperature and/or time of day.

Figure 113
Sensible and latent heat loss

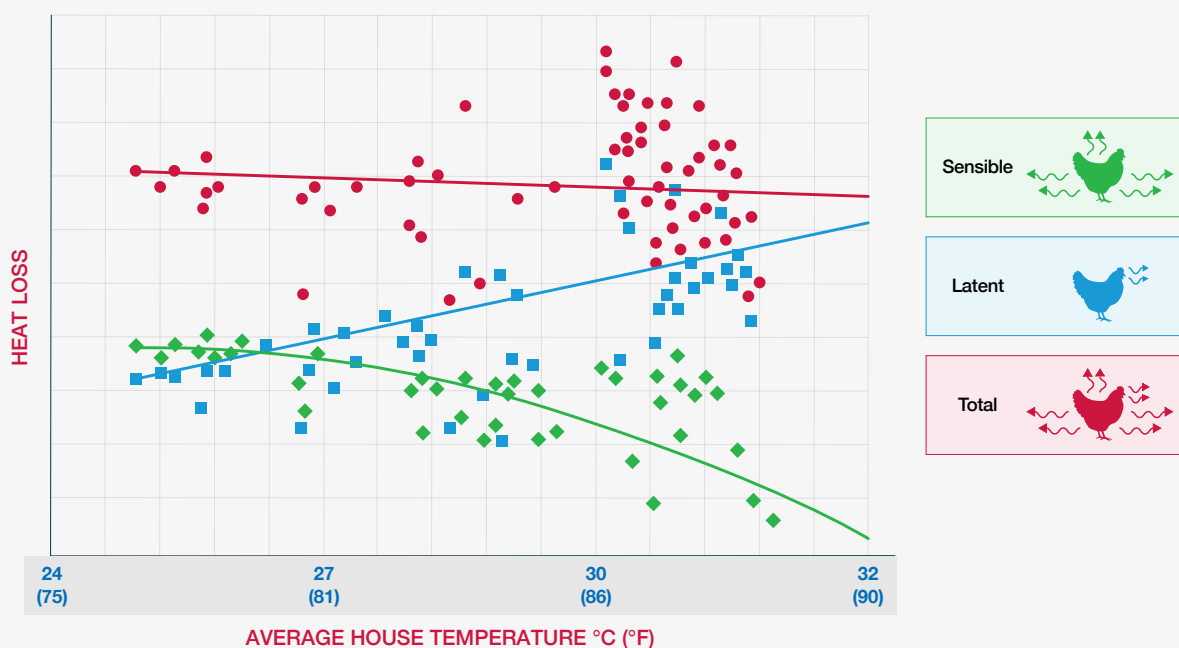

Combining the evaporative cooling with high air speed over the birds increases the amount of heat that the bird is able to lose to the environment around it and reduces its need to lose heat through panting.

Past recommendations have suggested avoiding the use of evaporative cooling when the house RH was higher than 70-75% to enable the bird to lose more heat through panting. Recent research has suggested that the bird is capable of tolerating a higher RH, provided there is sufficient air speed to help it lose heat from its body to the air around it. Also, the higher air speed (fast house air exchange rate) means that RH created by panting is rapidly removed from the house.

In hot, humid climates, when the natural RH approaches 100% in the afternoon/evening, high air speed through the house and a fast air exchange rate play a crucial role in keeping birds alive. In these conditions, it is vital that the house has been correctly designed (correct number of fans and correct size of tunnel inlet opening and cooling pad).

When air temperature decreases at night it does not necessarily mean that the birds will start to feel cooler. As air temperature decreases at night, the RH increases, making it more difficult for the panting bird to lose body heat. Remember that hot, panting birds sitting down on the litter are trapping heat between their body and the litter, regardless of the air speed above them. Having someone walk very slowly through the house to encourage them to stand up will assist them in losing some of this trapped heat. The birds must release the excess heat by the morning, or they begin the next hot day with accumulated heat from the previous day.



KEY POINTS

Evaporative cooling is used to enhance tunnel ventilation in hot weather.

High air speed is far more important than evaporative cooling.

There are two types of systems - pad cooling and fogging/misting.

Keep fans, foggers, evaporators and inlets clean.

Evaporative cooling adds moisture to the air and increases RH. It is important to operate the system based on RH and dry bulb temperature to ensure birds are comfortable.

Monitor bird behavior to ensure bird comfort is maintained.

Maximizing Tunnel Ventilation Air Speed

Maintenance is a critical part of maximizing air speed through the house. It is important to ensure that the fans are operating at their best. Check the fan belts and pulleys and ensure that the fan blade/impeller is turning at the recommended revolutions per minute (RPM). Ensure that the fan shutters are opening freely to the maximum opening and that any wire grids on the fans are free of dirt and dust. Shade cloth or any other material used on the outside of the fan may create a back pressure on the fan that will decrease its performance. If fan light traps are used, be sure to keep them well dusted at all times.

If there are partition fences within the house, try to use material with the largest hole sizes possible to assist with air flow through the house. A material with smaller hole sizes can be used down at floor level while the chicks are small.

Cooling pads should be clean and unblocked to allow the flow of air into the house. Check the distribution system to ensure good, even water distribution over the entire cooling pad.

In curtain-sided houses, make sure that the curtain closes fully and seals well along the top and bottom edges. Similarly, in houses with side wall inlets, be sure that the side wall inlets are fully closed during tunnel ventilation.

Air deflectors/baffles installed against the ceiling will help to increase air speed through the house. If using air deflectors, install the first deflector at the end of the cooling pads, ±9-10 m (29.5-32.8 ft) apart; the lower edge must be fixed so that it doesn't blow in the wind. They should be no less than 2 m (6.6 ft) from the floor, and there should be no gap between the top of the deflector and the ceiling.

Light Baffles/Traps

The use of light baffles/traps in broiler breeder facilities is common place, particularly during the rearing period when a controlled short day length of 8-9 hours is essential.

The use of light baffles on fans and inlets (**Figure 114**) will reduce ventilation capacities and should be taken into consideration when ventilation systems are being designed.

Figure 114
Example of a light baffle fitted to a side wall inlet.



Lighting

Objective

To achieve optimal reproductive performance through appropriate illumination (daylength and light intensity) and photostimulation (increase in daylength) at the correct age and body weight.

Principles

All broiler breeders are hatched photorefractory. This means that they are unable to respond positively to a stimulatory (long or >11 hours) daylength. The ability to respond to a stimulatory daylength depends upon birds being exposed first to a period of neutral or short days (8 hours), at least 18 weeks for typically grown broiler breeders. Long daylengths (≥ 11 hours) during the rearing period should be avoided as they will delay sexual development, reduce egg numbers and increase egg weight.

After prolonged exposure to long daylengths, birds become adult photorefractory. This means they are no longer responsive to a long stimulatory daylength, and production begins to decline.

Lighting for broiler breeders aims to dissipate juvenile photorefractoriness and ensure that all birds are photosensitive and can positively respond to stimulatory daylengths in ways that optimize lay. Where applicable, local legislation should be followed.



OTHER USEFUL INFORMATION AVAILABLE



Lighting for Broiler Breeders

Lighting During Brooding

Regardless of housing type, for the first 2 days after placement, birds should be given 23 hours of light and 1 hour of dark a day. This light schedule will help appetite development and promote feeding activity. Where closed (controlled-environment) housing is used during rear, daylength should be gradually reduced to 8 hours by 10 days of age.

Light intensity in the brooding area during the first few days should be bright (80-100 lux [7-9 fc]) to ensure that the birds find feed and water, but from 6 days of age this should be reduced to between 30 and 60 lux (3-6 fc).

Lighting Programs and Housing Type

Different types of housing in the rearing and/or laying periods mean that there are three common combinations of lighting environment:

1. Closed rearing house (controlled-environment) and closed laying house (controlled-environment).
2. Closed (controlled-environment) or blackout rearing house and open-sided (natural-environment) laying house.
3. Open-sided rearing house (natural-environment) and open-sided laying house (natural-environment).

The recommended lighting programs for each of these three environments are given in the next sections. All lighting programs will achieve 5% production at 25 weeks of age. If the target for production is different than 5% at 25 weeks, then the age at which first light increase is given should be altered accordingly. Typically, it will take between 14 and 21 days from photostimulation to 5% egg production, with lighter birds taking longer to start laying eggs than heavier ones.

Lighting Programs for Controlled-Environment Rearing and Controlled-Environment Laying

Controlled-environment housing during rear permits greater control over daylength. The ability to control daylength so that birds receive a constant short daylength from 10 days of age resolves many production problems (e.g., delayed sexual maturity, high female body weight, poor flock uniformity and high feed consumption) and gives better control of undesirable behaviors. The proportion of abnormal eggs and the risks of prolapse, broodiness and egg peritonitis and other conditions reducing welfare and performance can be minimized by ensuring that:

Birds are at target body weight for their age.

Birds have good body-weight uniformity.

The lighting programs shown in **Table 25** are followed.

Achieving satisfactory production from birds kept in controlled-environment housing depends on the adequacy of the light proofing. In dark periods, light intensity should not exceed 0.4 lux (0.04 fc). Measures should be taken to avoid light leakage through air inlets, fan housings, door frames, etc., and regular checks should be made to verify the effectiveness of the light proofing.

Light proofing is especially important during rear, when the birds need to experience a period of short days (8 hours) before they can become responsive to the pre-lay increase in daylength.

Table 26 details the recommended lighting program for birds kept in controlled-environment housing. In rear, a constant daylength of 8 hours is achieved by 10 days of age and maintained until photostimulation (transfer to a stimulatory daylength). Where there is a history of males in particular being underweight for age, day length can be reduced at a slower rate to reach 8 hours by 21 days.

Males must have access to ad lib feed during this period to maximize use of the extended program; however, avoid residual feed in the litter.

Table 26
Lighting programs for controlled-environment rearing and controlled-environment laying.

DAYLENGTH For Flocks with Different CV% at 140 Days (20 Weeks)			
BROODING DAYLENGTHS* (Hours)			
AGE (Days)	CV 8% or Less (79% Uniformity or Greater)	CV 8% or Greater (79% Uniformity or Less)	LIGHT INTENSITY†
1	23	23	80-100 lux (7-9 fc) in brooding area. 10-20 lux (1-2 fc) in the house.
2	23	23	
3	19	19	
4	16	16	
5	14	14	
6	12	12	
7	11	11	30-60 lux (3-6 fc) in the brooding area.
8	10	10	10-20 lux (1-2 fc) in the house.
9	9	9	
REARING DAYLENGTHS (Hours)			
10-146	8	8	10-20 lux (1-2 fc).
Days	Weeks	REARING DAYLENGTHS (Hours)	
147	21	11‡	8
154	22	12‡	12‡
161	23	13‡	13‡
168	24	13‡	13‡
175	25	13	13

† Average intensity within a house or pen measured at bird-head height. Light intensity should be measured in at least 9 or 10 places and include the corners, under lamps and between lamps. During the dark period (interpreted as night) a light intensity of ≤ 0.4 lux (0.04 fc) should be achieved. Ideally, variation in light intensity within the house should not exceed 10% of the mean.

‡ Daylength may be increased abruptly in a single increment without adversely affecting total egg production (although peak may be higher and persistency slightly poorer) provided the body weights are on target and the flock is uniform (CV% ≤ 8 or $\geq 79\%$ uniformity).

*Constant 8-hour daylengths should be reached by 10 days of age. However, if problems have regularly occurred with early body-weight gain, the reduction to a constant daylength may be more gradual so that 8 hours is not reached until 21 days.

To achieve the recommended 5% production at 25 weeks of age, photostimulation should not occur before 147 days (21 weeks). The actual age at which daylength is increased from short (8 hours) to long (≥ 11 hours) days depends on the average flock body weight and flock uniformity. Regular assessment of body weight, uniformity and pin-bone spacing should be used to determine timing of first light increase. An assessment of flock uniformity should be made at 140 days (20 weeks) of age or approximately 1 week before the first light increase is planned. It is a good practice to assess the flock every 3 - 4 days for uniformity of sexual maturity.

Flocks that are underweight (100 g [0.22 lb] or more below recommended target weight for age) or uneven (CV% greater than 8 or lower than 79% uniformity) should have photostimulation delayed (by at least 1 week). Transferring to long days before all birds have dissipated photorefractoriness will delay sexual development in those birds that are still photorefractory. This will result in a sexually uneven flock with poor peak rates of lay, widely ranging egg weights and difficult-to-manage nutrition.

During lay, there is no advantage in exceeding 13 to 14 hours of light per day at any stage (where light proofing is good, there is no need to go beyond 13 hours). Giving more than 14 hours of light will advance the onset of adult photorefractoriness and result in inferior rates of lay at the end of the laying cycle. Providing less than 13 hours of light during lay will increase the number of floor eggs as birds will lay eggs before lights-on.

Males reared to the recommended body-weight profile and lighting program will not require increases in daylength ahead of females. Achieving target body-weight profiles with good uniformity will ensure synchronization of sexual maturity between the 2 sexes (see section on *Management into Lay*).

Light Intensity (Luminance) in Lay

It is recommended that increases in light intensity are made at the same time as the increase in daylength. However, provided birds have achieved the target body weights and have good uniformity (CV% ≤ 8 or $\geq 79\%$ uniformity), it is the increase in daylength that stimulates sexual maturity and optimizes subsequent laying performance, not changes in light intensity. As long as the minimum intensity at bird head-height in the laying house is greater than 7 lux (0.7 fc), changes in light intensity when the birds are transferred from the rearing to the laying facilities have minimal effect on sexual development and subsequent egg production.

The recommended average light intensity at bird-head height in the laying house is between 30 and 60 lux (3 and 6 fc). This brighter intensity is recommended to encourage the use of nest boxes and maximize hatching egg production by minimizing the number of eggs laid outside the nest boxes.

Late Light Stimulation

In environmentally controlled housing where the photoperiod does not exceed 14 hours, adding 2 hours post 50 -weeks can have the effect of late flock light stimulation. In trials and field examples this has shown a positive improvement in egg production when a small temporary feed increase accompanies the increase in day length.

KEY POINTS

The maximum response to pre-lay increases in daylength is only obtained by achieving the correct body-weight profile during the rearing period, good flock uniformity and the appropriate nutritional input.

Birds should be provided with a constant short daylength (8 hours) by 10 days of age.

Where there is history of males being underweight for age, day length can be reduced at a slower rate to reach 8 hours by 21 days. Males must have access to ad lib feed during this period to maximize use of the extended program; however, avoid residual feed in the litter.

At least 18 weeks of short daylengths (8 hours) are needed during rear to dissipate juvenile photorefractoriness and ensure that all birds are photosensitive when they are transferred to stimulatory daylengths (≥ 11 hours).

An average intensity of 10-20 lux (1-2 fc) at bird-head height should be provided in the rearing period from 10 days of age.

Houses must be light-proofed to an intensity of no more than 0.4 lux (0.04 fc) during the dark periods. Any light leakage should be rectified immediately to ensure that the birds do not experience long days in rear.

The birds' reproductive response is maximized by a 13 or 14-hour daylength in the laying period. This will delay the onset of adult photorefractoriness and will minimize the incidence of floor eggs by ensuring that most eggs are laid after the lights come on.

An average intensity of 30-60 lux (3-6 fc) at bird-head height should be provided in the laying period.

Ensure males and females are synchronized in terms of sexual maturity by rearing them on the same lighting program and to the respective target body-weights-for-age.

**Lighting Programs for Controlled-Environment/
Blackout Rearing and Open-Sided Laying House**

Where controlled-environment rearing to natural-environment laying (**Figure 115**) is practiced, daylength should be maintained at 8 or 9 hours (see **Table 27**) from 10 days of age until the flock is photostimulated. In latitudes where problems such as prolapse, broodiness or high pre-peak mortality frequently occur, it may be advantageous to rear birds on a 10-hour daylength.

The flock should be transferred to open-sided laying houses (i.e., rear and move) or the blackout curtains should be opened (i.e., day-old to depletion) at the same time as the first pre-lay light increase is given (147 days [21 weeks] if the desired age at 5% production is 25 weeks).

There is no benefit to reproductive performance of providing birds with more than 14 hours of light during the laying period.

However, where birds are kept in open-sided houses and the longest natural daylength exceeds 14 hours, the combined natural and artificial lighting during the laying period may be increased beyond 14 hours to equal the longest natural daylength. This increase will prevent the birds from experiencing a decrease in daylength after the longest natural daylength has occurred in mid-summer.

To ensure the synchronization of sexual development, rear males and females on the same lighting program.

 **KEY POINTS**

Where birds are kept in open-sided housing during lay and the longest natural daylength exceeds 14 hours, the combined artificial and natural lighting may be extended beyond 14 hours to equal the longest natural daylength.

Figure 115
Example of an open-sided (natural-environment) laying house.



Table 27
Lighting programs for controlled-environment/blackout rearing and open-sided house laying.

NATURAL DAYLENGTH (Hours) at 147 Days (21 Weeks)									
	9	10	11	12	13	14	15		
AGE (Days)	BROODING DAYLENGTH (Hours) ‡							LIGHT INTENSITY†	
1	23	23	23	23	23	23	23	80-100 lux (7-9 fc) in brooding area. 10-20 lux (1-2 fc) in the house.	
2	23	23	23	23	23	23	23		
3	19	19	19	19	19	19	19		
4	16	16	16	16	16	16	16		
5	14	14	14	14	14	14	14		
6	12	12	12	12	12	12	12	30-60 lux (3-6 fc) in the brooding area. 10-20 lux (1-2 fc) in the house.	
7	11	11	11	11	11	11	11		
8	10	10	10	10	10	10	11		
9	9	9	9	9	10	10	10		
REARING DAYLENGTHS (Hours)									
10-146	8	8	8	8	9	9	9	10-20 lux (1-2 fc).	
Days	Weeks	REARING DAYLENGTHS (Hours)							
147	21	12#	12#	12#	13#	14	14	15§	30-60 lux (3-6 fc).
154	22	13#	13 #	13#	13#	14	14	15§	
161	23	14	14	14	14	14	14	15§	

‡ Constant 8-hour daylengths should be achieved by 10 days. However, if problems have regularly occurred with early body-weight gain, reaching the constant daylength may be delayed until 21 days.

† Average intensity within a house or pen measured at bird-head height. Light intensity should be measured in at least 9 or 10 places and include corners, under lamps and between lamps.

The daylength may be increased abruptly in a single increment without adversely affecting total egg production (although peak may be higher and persistency slightly poorer), provided the body weights are on target and the flock is uniform (CV% < 8 or ≥ 79% uniformity).

§ There is no benefit from exceeding a daylength of 14 hours. If the longest natural daylength exceeds 14 hours, the combination of natural and artificial light should be increased to equal the expected longest natural daylength.

¶ If problems occur in out-of-season flocks (i.e., delayed sexual maturity), the flock may be photostimulated at 140 days (20 weeks) provided the body weights are on target and their CV% is no more than 10 (no less than 70% uniformity).

Artificial Lights and Light Intensity

In open-sided housing, it is important that the light intensity provided during the period of artificial lighting is bright enough to ensure photostimulation. The target light intensity in the house is 30-60 lux (3-6 fc). During times of the year when flocks have been reared in high-intensity natural light (i.e., spring-hatched birds), higher intensities of artificial light will need to be provided in the laying house. This light intensity is essential to ensure satisfactory reproductive performance.

Supplementary artificial lighting should be given at both ends of the natural day. This will clearly define the birds' day and ensure that the daylength does not vary due to changes in sunrise and sunset. The transition from natural darkness to artificial lighting in the morning will give a definite "dawn" signal to the birds, and the transfer from artificial lighting to natural darkness will give a definite "dusk" signal. The latter is important, because dusk controls the timing of ovulation, and as a consequence, the time of egg laying. The proportion of artificial lighting given at each end of the birds' day will depend on management factors such as what time the farm staff start work and when eggs are required for collection.

In open-sided houses, seasonal effects can be significantly reduced if the intensity of the natural light entering the house is reduced. The use of black plastic horticultural netting, for example, will reduce the intensity of the light entering the house, while still allowing adequate ventilation. The netting should be removed at the first pre-lay light increase.

Seasonal Variations in Natural Daylength

When rearing and/or laying houses are open-sided, seasonal variations will affect performance. Seasonal changes are gradual, so a precise definition of whether certain months of the year are classified as in- or out-of-season is difficult to establish. Some months are neither one nor the other. Latitude will influence seasonal effects (**Figure 116**).

✓ KEY POINTS

Birds may be slower to come into lay if the artificial light intensity at the first pre-lay light increase is less than 60 lux (6 fc) when they have been reared on high-intensity natural daylight.

Artificial light should be given at both ends of the day to maintain a fixed daylength.

Figure 116
Natural daylengths at latitude 10° or 30° north or south.

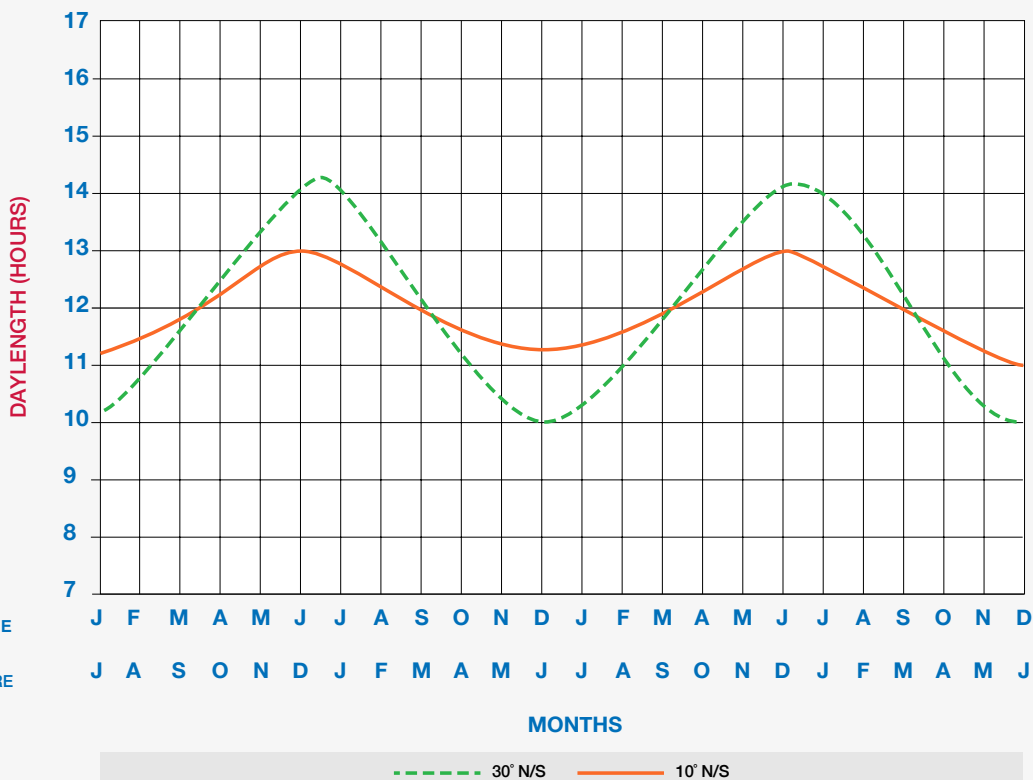

The months in which the birds are placed are classified as in-season or out-of-season in **Table 28**.

Table 28
Classification of months of placement as in-season or out-of-season.

IN-SEASON		OUT-OF-SEASON	
Northern Hemisphere	Southern Hemisphere	Northern Hemisphere	Southern Hemisphere
September	March	March	September
October	April	April	October
November	May	May	November
December	June	June	December
January *	July *	July *	January *
February *	August *	August *	February*

*These 4 months are difficult to define. The degree of seasonal effect in these months will depend on latitude. Slight modifications of the lighting programs and body-weight profiles may be necessary.

Out-of-Season Flocks

The age at onset of lay for flocks hatched between March and August in the Northern Hemisphere, and between September and February in the Southern Hemisphere will be delayed due to the birds having no or insufficient short days (8-10 hours) to satisfactorily dissipate photorefractoriness and make the birds photosensitive.

Compared to in-season flocks, out-of-season flocks will come into production later and have lower peaks, larger eggs and less predictable reproductive performance throughout lay. Sexual maturity for out-of-season flocks can be advanced by easing the degree of body-weight control (see the **Ross Parent Stock Performance Objectives** for more information). Growing out-of-season females to a heavier out-of-season body-weight target will allow photorefractoriness to be dissipated more rapidly, helping to reduce issues of egg production and egg size.

The performance of out-of-season birds can be improved by rearing them in brown-out housing (use of netting to reduce light penetration into the house) on short (8-10 hours), artificial daylengths. However, it is unlikely that production from out-of-season flocks will ever be as good as that from in-season (autumn-hatched) flocks. The pre-lay light increase should be given at 147 days (21 weeks), if desired age at 5% production is 25 weeks, and given as a single increment to 14 hours or 15 hours where the longest anticipated natural daylength is longer than 14 hours.

In-Season Flocks

In-season flocks should be grown to the target body-weight profile and the first pre-lay light increase given at 21 weeks (147 days) to achieve 5% at 25 weeks of age.

KEY POINTS

The lighting program for both in-season and out-of-season flocks is the same (see Table 27).

Out-of-season birds should be grown to a heavier out-of-season body-weight profile.

In-season birds should follow the standard target weights.

Considerations for Lighting Management

Vision Difference in Poultry

Light Penetration

In poultry, light has the ability to reach the photo-receptors in two ways: through the retina and via direct penetration of the skull to the photo-receptors located in the hypothalamus of the brain. Wavelengths vary in their ability to penetrate to the brain; for example, long wavelengths (such as red light) appear to penetrate cranial tissue more than short wavelengths (such as blue light). These differences may result in changes to the physiological or behavioral responses of the bird.

Color Vision

Color vision is defined by the number of different types of cone cells in the retina. The more types of cone cells the more colors perceived. Humans have 3 types of cone cells and can distinguish between 3 colors: red, green and blue. The retina of poultry contains 4 types of cones, an additional type of cone cells for perception of ultra violet (UV) light, which is beyond those visible to the human eye (**Figure 117**). To account for this, Gallilux/clux (what poultry see) instead of, or in addition to, lux (what humans see) should be measured. The effects of light color (wavelength) and intensity on breeders are mainly behavioral, not productive.

Figure 117
UV vision in birds.

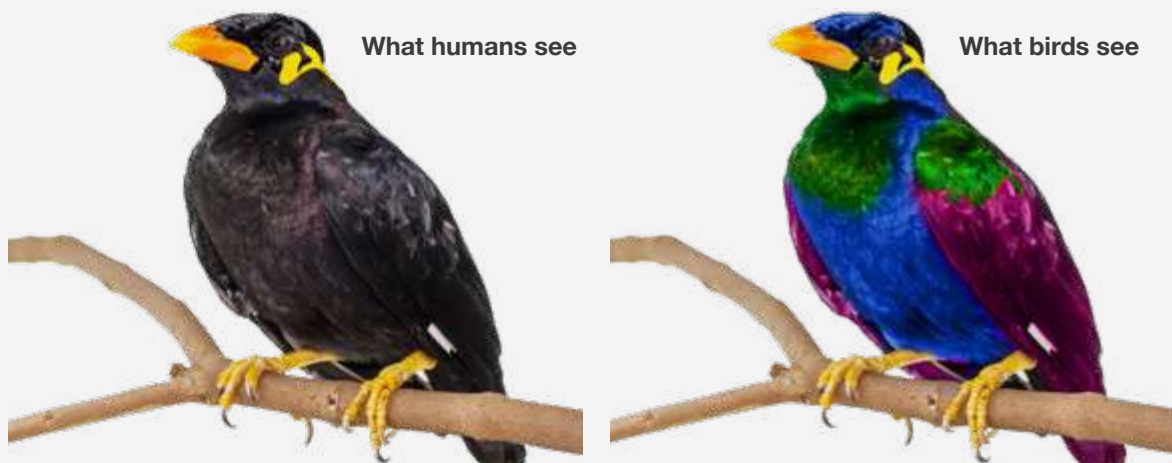

Flicker

Compared to humans, birds have a high flicker fusion rate (the frequency at which it can no longer be perceived) which creates the ability to see fast-moving objects. This aspect of a bird's vision is important when considering lighting because birds will be able to detect flicker (a visible change in brightness) when humans do not. Flicker leads to stress, which will eventually lead to decreasing animal welfare and performance. Flicker has been found to reduce important behaviors such as eating, drinking, preening and bill wiping in starlings.

Measuring Light

Because chickens perceive light differently, it is reasonable to measure light intensity differently. Depending on the light source and color spectrum birds may perceive light intensity to be up to 50% or higher than that measured by a lux-meter. Therefore, it is valid to use an approach that corrects for this. Specific Gallilux meters are available, but normal light meters sold for agricultural purposes will have conversion tables for converting lux to Gallilux in the instruction booklets provided with them. Determining what light intensity is actually perceived by the birds will allow a more accurate selection of suitable light and more precise management of lighting.

The light meter needs to be appropriate for the light type. For example, not all agricultural light meters are necessarily accurate for light emitting diode (LED) lights.

Wavelength (Light Color)

There is no strong scientific evidence to show that one particular bulb color of light gives better performance in broiler breeders when comparing white light, which contains all colors of the light spectrum (**Figure 118**).

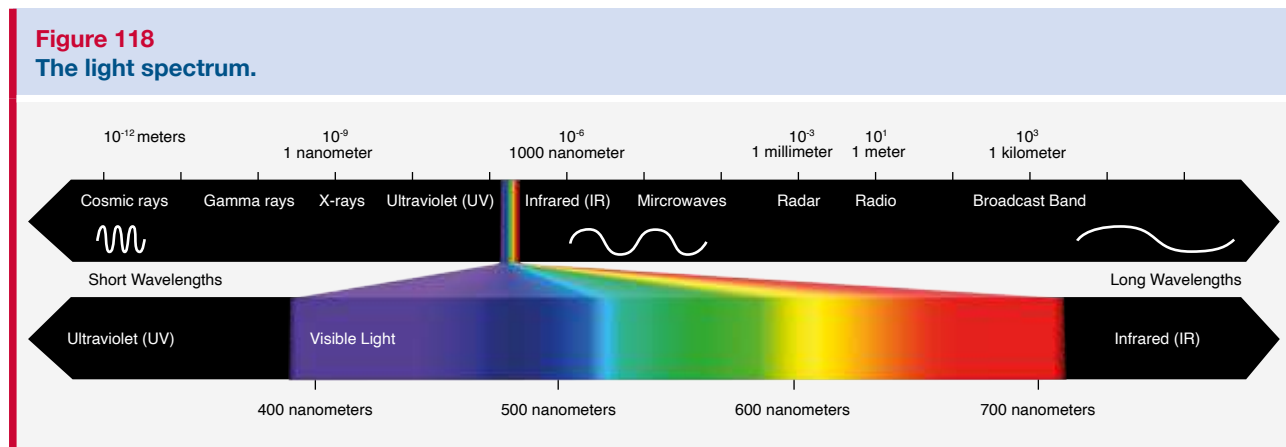

Some work suggests that providing sufficient light from the red end of the spectrum within the white light provided to breeders is important for sexual maturation. This could be related to the fact that the longer wavelength of red light (**Figure 118**) penetrates the skull into the hypothalamus (which is responsible for photo-sexual responses) more easily. It is, therefore, important that the light used for parent stock has sufficient red wavelengths in it. Blue light during production was reported to be negative for breeder welfare due to its impact on feather pecking and aggression.

Color Temperature

Color temperature is the temperature required to heat a blackbody (something black) to get a specific color. The color temperature of white light is measured in degrees Kelvin (K) on a scale from 1,000 to 10,000 (**Figure 119**).

At the lower end of the scale, < 3000K, the light produced is considered “warm white” where red is the dominant wavelength. Above 4000K the light produced is considered cool and the dominant wavelength is blue.

Knowing the K value of the lights will provide information about the dominant wavelength within that light. This allows the right sort of light bulb to be chosen for the specific circumstances of the flock. For example, cool white, >6000k, may have benefits in the rearing house due to the promotion of melatonin which can aid calmness in the flock and promote growth. It might be beneficial to give breeders light with a K value < 3000K (i.e., where red light is dominant) because red wavelengths are important for sexual maturation.

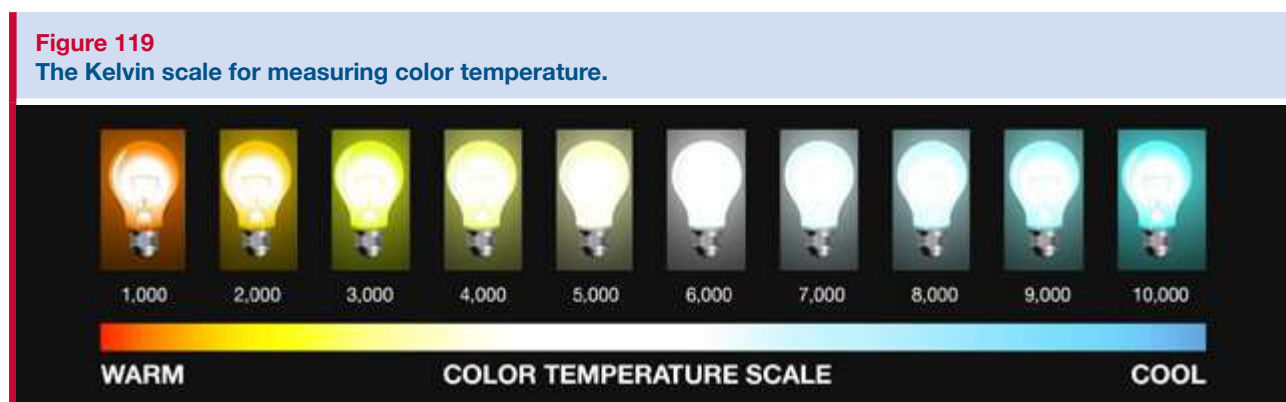

Provision of Light – Lamp types

There are no data to show that one type of lamp induces better performance than any other, and so lamp choice will depend on availability, capital outlay, running costs, and the ability to dim using conventional voltage-reduction equipment. The advantages and disadvantages of various lamp types are given in **Table 29**, below.

Table 29
Advantages and disadvantages of different lamp types.

Lamp Type	Advantages	Disadvantages	Wavelength Spectrum
Incandescent	<ul style="list-style-type: none"> Good spectral range. Can be used with dimmer. Inexpensive. 	<ul style="list-style-type: none"> Inefficient. Lasts 700-1000 hrs and need to be replaced frequently. ~15 lumens/watt (tungsten). 25 lumens/watt (halogen). High energy cost. 	<ul style="list-style-type: none"> Warm light. Mixture of wavelengths. 300-700 nm – good red light spectrum output.
Fluorescent/ Compact Fluorescent	<ul style="list-style-type: none"> More efficient than incandescent. Use less power. Last longer. Reduce electricity cost compared to incandescent. Relatively inexpensive but more expensive than incandescent. 	<ul style="list-style-type: none"> Difficult to dispose of (contain mercury). Can't be used with dimmer. Loses intensity over time. Issues with flicker. Does not reach maximum intensity immediately when turned on. 	<ul style="list-style-type: none"> White light. 400-700 nm – similar color spectrum to incandescent lights. Available in both cool and warm spectra (K). Emits very specific wavelengths and these are combined to provide the color needed, but intermediate wavelengths are missing.
LED	<ul style="list-style-type: none"> Energy efficient. 200 lumen/watt. Last up to 50,000 hrs. Specific lighting colors can be chosen. Some can be used with a dimmer. 	<ul style="list-style-type: none"> High initial cost. Cheaper lights will not have suitable light spectrum or be suitable for the environment in the poultry house. Flicker can be a problem if not installed correctly. 	<ul style="list-style-type: none"> Provides a full spectrum of light. The actual light color spectrum can be changed depending on the chemicals used in the light.
Halogen	<ul style="list-style-type: none"> Luminous efficiency. Stable color temperature. Almost no light decay. More efficient than incandescent. 	<ul style="list-style-type: none"> Not ideally suited to dusty environments. Less efficient than LED and fluorescent lamps. More expensive than incandescent lamps. Emits a lot of heat. 	<ul style="list-style-type: none"> Produces continuous spectrum of light (like incandescent lamps) but the spectrum is shifted towards blue.
Sodium Vapor	<ul style="list-style-type: none"> Energy efficient. Long life span Consistent color temperature (warm). 	<ul style="list-style-type: none"> Sodium is hazardous. Warm up time is required (5-15 mins). Require a ballast. 	<ul style="list-style-type: none"> Warm light with highest intensity in yellow, red and orange. Color temperature is ~2100K.

Uniformity of Light Intensity

Light must be uniformly distributed throughout the house. Frequent changes in contrast between high and low light intensity causes eye discomfort. It can also encourage management issues such as floor eggs. Lights should be evenly distributed throughout the house and be equidistant from the house floor. Reflectors placed on top of the lights can help to improve light distribution. Lights must be kept in good working order.



KEY POINTS

Vision of poultry is different from humans in the way they receive light, color spectrum and sensitivity to flicker.

The provision of a warm white light for broiler breeders is important for sexual maturity, and additional UV-A may aid fertility.

Lamp type does not have an effect on reproductive performance.

Light must be evenly distributed throughout the poultry house, and light intensity should be routinely measured throughout the flock.



Notes

A series of horizontal dotted lines spanning the width of the page, intended for handwritten notes.

Section 8: Nutrition

Nutrition

Objective

To maximize welfare, reproductive potential (of both males and females) and chick quality, by supplying a range of balanced diets that meet the requirements of parent stock at all stages of development and production.

Principles

Maintaining good uniformity and keeping close to body-weight targets are essential in feeding parent stock. Feed composition, feed form, feeding management and general management must be considered together when assessing parent stock performance. Economic analysis of the whole broiler production cycle shows that small improvements in breeder or chick performance will cover the costs of improving nutrient levels in the breeder feed. In general, a high-quality diet for parent stock is economically justified.

Broiler Breeder Nutrition

Feed formulation and feeding management are combined to achieve target body weights and good uniformity throughout the life of the breeder flock.

Nutrition exerts a significant influence over the productivity and profitability of parent stock flocks. Designing successful parent stock feeding strategies requires the input of a nutritionist; however, flock managers should be aware of the general nutritional content of feed. Such information can be obtained from the feed suppliers themselves or nutritional consultants. Most importantly, there should be farm-level sub-sampling of diets and routine laboratory analysis to determine if expected dietary nutrient contents are being achieved. It is important that managers are aware of the make-up of the diet that is being fed to their stock to ensure that:

Feed levels and consumption will provide adequate levels of daily nutrient intake (feed intake x nutrient concentration).

There is proper and expected balance between feed nutrients.

Routine laboratory analysis of diets can be usefully interpreted and correct actions taken such as:

- Alerting the provider of a possible discrepancy in formulation.
 - Appropriate management of feeding programs.
-

Supply of Nutrients

Diets should be balanced on the basis of the intake of digestible nutrients. An excess or deficiency of any key nutrient could negatively impact total flock and progeny performance.

In practice, the supply of nutrients to parent stock is controlled through the nutrient composition of the feed and the level of feed intake, these must always be considered together as changes in either one of these factors will impact supply of nutrients and therefore, overall development and performance.

Guidelines for daily feed intakes and for adjusting them according to observations of bird performance, have been discussed in earlier sections of this handbook. These guidelines are made with reference to the dietary energy levels given in the recommended **Ross Parent Stock Nutrition Specifications** for rear and production diets.

While recommended nutrient specifications are given as dietary concentrations, the daily nutrient intake (i.e., the amount of nutrients that the bird requires in a day at any given time in its life needs) should be considered when making feeding decisions. This is especially important when feed intakes may vary, such as when high temperatures result in lower feed intake.

Feed Intake

Daily feed intake per bird is influenced by both genetic and environmental circumstances. Control of feed supply is a major mechanism for effective flock management, and therefore, feed intake expectations are important both to determine required diet nutrient density and to make management decisions.

The daily bird requirement for a nutrient is satisfied by the product of presumptive feed intake and nutrient concentration. Recommendations for nutritional concentrations, as in the **Ross Parent Stock Nutrition Specifications**, assume the achievement of feed intakes as given in the **Ross Parent Stock Performance Objectives**.

Energy

Feed energy is conventionally expressed as apparent metabolizable energy (ME) level corrected to zero nitrogen retention (AMEn), as these values are a more accurate description of energy value. Data on energy contents

expressed in this way are available from many sources. In this Handbook, the term ME is used to describe AMEn. The ME values used in **Ross Parent Stock Nutrition Specifications** are based on assays published by the World's Poultry Science Association (WPSA).

Birds respond to nutrient intake, not nutrient concentration of the feed. If diets have been formulated to energy levels different to those given in the **Ross Parent Stock Nutrition Specifications**, proportional changes in feed allowances must be made. An example of adjusting feed volumes for a 2800 kcal/kg (1270 kcal/lb) to a 2700 kcal/kg (1225 kcal/lb) feed is given below:

Adjusting Feed Volumes Calculation

METRIC

Energy intake

$$= 166 \text{ g/bird/day} \times (2,800 \text{ kcal/kg} \div 1000)$$

$$= 464.8 \text{ kcal/bird/day}$$

Adjusted feed intake

$$= 464.8 \text{ kcal/bird/day} \div (2,700 \text{ kcal/kg} \div 1000)$$

$$= 172 \text{ g/bird/day}$$

IMPERIAL

Energy intake

$$= 36.6 \text{ lb/100 birds} \times 1,270 \text{ kcal/lb}$$

$$= 46,468 \text{ kcal/100 birds}$$

Adjusted feed intake

$$= 46,468 \text{ kcal/100 birds} \div 1,225 \text{ kcal/lb}$$

$$= 37.9 \text{ lb/100 birds}$$

The total daily energy need for a bird is the sum of energy required for maintenance, growth and production of egg mass. The maintenance energy requirement is, by far, the largest component of total energy need. Maintenance energy need is based on the bird's body weight and is significantly affected by environmental temperature. Total energy requirement will, therefore, vary with environmental temperature, location and season. Adjustment of energy supply must therefore be based largely on observation of the birds' responses in body weight, body condition, feather condition, health status, feed clean-up time and egg mass.

The choice of dietary energy level should be based on a combination of factors, including feed management, environmental management, welfare and economics. In particular circumstances, varying the feed energy level may be justified if feed intakes are not on target, or if economics dictate a change in feed energy level. If feed energy levels differ from those suggested in the recommended nutrition specification tables, the concentrations of other nutrients in the diets must also be adjusted to maintain a constant ratio of these nutrients to energy. The nutrient:energy ratio should be reviewed before any adjustments are made to feed levels. An example of nutrient adjustments to energy is given in the section *Grower Diets*.

Energy content of successive feeds should not vary widely. Feed changes should be gradual and carefully controlled, especially when changing diets (e.g., transition from rear to production diets).

Within a given diet, consistency in nutrient density and quality is critical. Ingredients that are variable in nutrient composition and digestibility should be used with caution. Avoid large changes in feed ingredients and energy concentrations between deliveries to a given flock.

Carbohydrate-degrading enzymes are often added to poultry diets to enhance the energy released from specific raw materials. Energy contributions from these enzymes are well established in broilers, while less information is available for breeders. Therefore, conservative energy matrices should be applied.

Protein and Amino Acids

Amino acids are the building blocks of all proteins; therefore, feed must provide sufficient levels of amino acids to ensure optimal body, feather and egg protein deposition. Aviagen advises minimum levels of essential digestible amino acids (those that must be supplied by the diet and cannot be synthesized by the bird) and a minimum for crude protein (CP). However, the advice given for digestible lysine (dLys) should be viewed as both a minimum and maximum, due to its large influence on breast muscle accretion and body-weight gain. Achieving the correct level of essential digestible amino acids is critical for bird development and production. Achieving a minimum for CP is advisable, ensuring a pool of non-essential amino acids necessary for various body proteins and in particular feather development.

Specific nutrient recommendations are given in the **Ross Parent Stock Nutrition Specifications**. The digestible amino acids are based on standardized ileal digestibility (SID). Formulating diets on a digestible amino acid basis is more accurate and cost effective.

Macro Minerals

The macro minerals calcium (Ca) and phosphorus (P) are critical for proper skeletal development, reproductive performance, shell quality and other metabolic functions.

Broiler breeders in production require approximately 5 g of Ca per hen per day (14-18 oz of Ca per 100 birds) to maintain Ca balance. In practice, this requirement is satisfied by feeding recommended breeder ration Ca levels from onset of lay.

For optimal Ca release through the day, in particular at the point of calcification of the eggshell, utilizing a mix of coarse (2-3 mm) and fine (<1 mm) limestone in production feeds is advised. When birds are fed early in the day, the fine particle limestone in the feed is rapidly absorbed and excreted via the kidney before eggshell is formed, while the coarse particles are absorbed more slowly and available later in the day when required for calcification.

When encountering ongoing issues with eggshell quality, despite multiple production diets with increasing levels of Ca, supplement the flock with 1 g (0.03 oz) Ca per bird per day, in the afternoon, in the form of a biosecure source of large particle-sized limestone or oyster shell.

One effective way to provide this supplement is to evenly broadcast it on the house litter area. However, supplemental Ca sources should not be allowed to build up in the litter, since excessive Ca intake can be detrimental to shell quality. If build up of the Ca supplement in the litter does occur, supplementation should be discontinued until the flock has consumed any supplemented Ca remaining in the litter. If mash feeds are used, large particle-sized limestone or oyster shell can easily be incorporated into the diet.

Adequate available P intake is critical for skeletal structure and eggshell quality. Excessive levels of available P throughout lay reduce shell quality and have a negative impact on hatchability. Feeding recommended available P levels will ensure adequate eggshell quality.

Levels of sodium (Na), chloride (Cl) and potassium (K) above required levels will likely lead to an increase in water intake, negatively impacting litter quality and eggshell quality. It is important to control dietary levels of these nutrients to avoid such problems occurring.

Mineral Imbalance and Metabolic Disorders

Calcium tetany of broiler breeder hens is occasionally seen with mortality appearing from 25 to 30 weeks of age. Hens suffering from calcium tetany are found paralyzed or dead in the nest in the morning, with active ovaries and an egg in the shell gland with a partially formed shell. No other pathology may be observed upon post-mortem inspection. The occurrence of this condition is rare when the recommendations concerning feeding of Ca in the period leading to production and in the first period of production are followed.

Low available P and K can lead to sudden death syndrome (SDS). When Aviagen's specifications for P and K are followed in the pre-breeder and breeder 1 phases, SDS incidence is low. However, when it occurs in early lay, birds are seen to die suddenly in the breeder house. At post-mortem, there is an enlarged flaccid heart, congested lungs and pericardium in some birds. The SDS-affected flocks usually respond to K supplementation in the drinking water and the feed.

Added Trace Minerals

Recommended levels of supplementation for trace minerals in the premix can be found in the **Ross Parent Stock Nutrition Specifications**. Generally, organic chelated trace elements have higher biological availability than inorganic sources. When using inorganic sources of trace minerals, the oxide form generally provides the lowest biological availability.

Added Vitamins

Vitamins are critical to all aspects of growth, reproductive and progeny performance. Under demanding conditions, disease outbreaks and other situations, birds can show a positive response to higher levels of certain vitamins. The goal should be to remove or reduce sources of distress or disturbance, rather than to depend on permanent use of excessive vitamin supplementation for optimal performance.

Vitamin potency is sensitive to many factors (e.g., moisture, trace minerals, choline level, storage time and heat) that can reduce its shelf life. Quality control measures must be in place to ensure vitamin levels in the finished feed meet the recommended nutrient specifications.

Vitamin E is one of the most expensive vitamins and has several biological functions impacting the immune and reproductive systems, so it is important to ensure that the level of this vitamin in the diet is sufficient. Research has shown that recommended levels also enhance the immune system of newly hatched chicks. Recommendations for all vitamins are included in the **Ross Parent Stock Nutrition Specifications**.



KEY POINTS

Understand the nutrient composition of the diet to ensure quality control and to correctly manage feeding levels.

Dietary nutrients are balanced to energy concentration. Feeding levels must be altered accordingly in response to changes in dietary energy concentration.

Feed should not be stored on the farm and should be used within 10 days of delivery.

Provided diets are properly formulated, the greatest effects of diet on performance are through non-optimum feed intake levels.

Feeding Programs and Diet Specifications

Feed specifications and feeding management must always be considered together. Different feed specifications may be used with equal success, provided they lead, together with the feed management procedures, to the required bird performance. The main factors influencing feed specifications include cost and availability of feed ingredients, feed processing technology and bird management procedures.

Feed should be formulated to meet nutrient specifications and be consistent over time. Sudden changes in feed ingredients or in other characteristics that may reduce feed intake, even transiently, should be avoided. Feed management and composition must be guided by close monitoring and observation of the flock.

Starter Period

A feature of successful breeder performance is to achieve proper early growth and physiological development. This requires at least one starter feed.

Achieving early nutrient intake is the primary purpose of the starter feed. Therefore, good physical quality is important, either in the form of a sieved crumb or mini pellet. Typically, the starter feed(s) will be given for about 28 to 42 days.

Take care to avoid presenting partially ground pieces of grain to the chicks that they can preferentially select from the diet. Individual chicks will select these large pieces to the exclusion of the crumbs and consequently receive an imbalanced diet.

A grower feed will follow immediately after the starter period. This grower feed will contain lower CP and amino acid specifications than the starter feed to control body-weight gain.

During changes from starter to grower feed, body weight should be monitored carefully to safeguard against checks in growth. This is especially important when there is a change in feed ingredients and/or feed form.

When early body-weight targets are not achieved, more often observed with the male breeder, and management factors are eliminated, adapting or revising the starter strategy (number of diets and nutrient density) may be necessary.

Table 30
Process of defining nutrient levels based on a 2800 kcal/kg specification.

		Grower	Diluted Grower	
Energy	kcal/kg	2800	2700	2600
CP	%	14	13.5	13.0
dLys	%	0.52	0.50	0.48
dMet	%	0.36	0.35	0.33
Calcium	%	0.9	0.87	0.84
avP	%	0.45	0.43	0.42

Adjusting dLys Concentration Calculations based on different energy levels

Establishing the correct level of dLys at 2700 kcal/kg:
 $(0.52/2800) * 2700 = 0.50$

Establishing the correct level of dLys at 2600 kcal/kg:
 $(0.52/2800) * 2600 = 0.48$

Grower Diet

The grower phase is one of the most influential feeding stages due to its length and objective to promote uniformity and optimal female and male body confirmation. In some situations, feed distribution might be compromised by feeding equipment and/or low volumes. Diluting the grower diet is an effective way of countering these problems and, therefore, optimizing feeding behavior and uniformity.

Irrespective of the level of dilution, it is critical to establish a strict control on the relationship between energy and dLys, as any excess of lysine will be utilized for breast deposition, interfering with body weight and body confirmation uniformity.

It is not always easy to manufacture a lower density grower diet (<2700 kcal/kg) with a controlled level of lysine due to the lack of availability of diluents (raw materials low in energy and amino acids, and often high in crude fiber) in certain areas of the world.

When the required raw materials are available, the emphasis should be on ensuring the dLys level in the formula is correctly established; this is much more important than CP in terms of body-weight control, breast development and body fat reserve deposition.

Table 30 illustrates the process necessary to define nutrient levels in a 2700 kcal/kg and 2600 kcal/kg grower diet based on a 2800 kcal/kg specification.

For example: several feeding strategies can be followed to lead to successful production. A rearing program should consider multiple phases in order to ensure adequate nutrient delivery and sufficient feed volumes. This might include:

Higher nutrient density starter diet to support adequate early development, particularly for males.

Second starter diet to provide a smoother transition to a lower-specification grower diet.

Lower-density grower diet to allow greater control of body-weight development and increase feed distribution during this period. Although the diet itself has a reduced concentration of nutrients per kg, the recommended feed intakes and increasing feed consumption over this phase of growth will ensure the required increase in daily nutrient supply.

Developer diets with a lower density help with body-weight control and feed distribution, and smooth the transition to a pre-breeder diet.

Pre-breeder diet to provide consistent amino acid and protein intake while increasing energy and Ca intake for adequate development of reproductive tissue.

Transition to Sexual Maturity

Sufficient amino acids and other nutrients are required for the proper development of reproductive tissues. This can be achieved by implementing the recommended pre-breeder (and developer) diet.

The Laying Stage

Feed compositions given in the **Ross Parent Stock Nutrition Specifications** will support target levels of production in properly reared, uniform flocks. Performance during the laying stage is often affected by feeding and management practices applied during earlier stages of growth. Increasing feed allowances because of poor egg production should be undertaken with caution and a clear understanding of the flock's nutritional status.

In most flocks, using more than one breeder feed may be nutritionally advantageous in meeting the increasing Ca and reduced amino acid requirements of older birds. **Ross Parent Stock Nutrition Specifications** advise a 3-stage feeding program in production to optimize nutrient needs, feed costs, egg weights and body conditioning.

Temperature Effect on Energy Requirements

Environmental temperature is a major factor influencing energy requirements of the bird. As operating temperature differs from 23°C (73°F), energy intakes should be adjusted pro rata as follows:

Increased by 6 kcal (1.2 kcal/1°C) per bird per day if temperature is decreased by 5°C (9° F) from 23 to 18°C (73 to 64°F).

Reduced by 7 kcal (1.4 kcal/1°C) per bird per day if temperature is increased from 23 to 28°C (73 to 82°F).

The influence of temperatures above 28°C (82°F) on energy requirement is not as straightforward as the effect of cold. At temperatures above 28°C (82°F), the bird's need to dissipate heat results in an increased daily energy requirement. However, this is difficult to achieve because of reduced appetite. Therefore, feed composition, feed amount and environmental management should be controlled to reduce heat stress. Providing correct nutrient levels and using feed ingredients with higher digestibility will help to minimize the effect of heat stress. Increasing the proportion of the feed energy that comes from feed fats (rather than carbohydrates) may also be beneficial.

In addition to absolute temperature measurement, the effective temperature of birds can be monitored by measuring of bird performance against the target and observation of bird behavior.

Male Nutrition

Separate control of male feeding level using separate-sex feeding systems is essential for successful broiler breeder production.

The use of a specific male diet in the laying period has been shown to be beneficial to the maintenance of male physiological condition and fertility. A separate male diet with lower protein and amino acid levels can prevent excessive breast muscle development, while adequate dietary supplementation of vitamin E and selenium (Se) and reduced Ca are critical for sperm quality. The use of an organic chelated form of Se should be considered. More detail can be found in the **Ross Parent Stock Nutrition Specifications**.

If a separate male diet is used, it should be introduced when the flock reaches 5% production. When switching to a separate male diet, ensure caloric intake is not reduced if the male diet is lower in energy density than the current diet being fed (dietary energy levels for a separate male diet should be between 10.9 and 11.7 MJ (2600 and 2800 kcal ME per kg).

✓ KEY POINTS

Birds respond to daily intakes of nutrients. Therefore, feeding programs (and feed levels) must relate to dietary nutrient content, especially energy and the nutritional requirements of the bird at a given age.

Economic and management practices may demand flexibility in diet nutrient concentration, but in general, variability in nutrient specification should be avoided.

Nutritional problems will be observed as failures to achieve production and welfare targets and should be discussed with the nutritionists at the earliest opportunity.

Diets need to be regularly sampled and the samples analyzed to ensure that the diet is as it should be.

Feed Manufacturing

Following good feed manufacturing practices will ensure that parent stock receive diets with adequate nutrient fortification, while minimizing potential contaminants. Unseen variations in feed ingredient quality and nutrient content are possible causes of bird failure to attain production targets. Frequent and routine control checks upon the physical quality and nutrient content of feed should therefore be completed.

Feeds should be regularly handled and examined by nose and eye (and if necessary, microscope). Sub-sampling and analysis of feeds are essential to detecting anti-nutritional factors and ensuring that requirements for specific nutrients are being met.

Ingredient formulations, and their alteration with changing ingredient price, should be a subject for discussion with the feed manufacturer and by close examination of declarations of ingredients and specifications.

Raw material physical quality, ingredient nutritional content and feed processing techniques must be of a high standard and consistent from batch to batch for a given flock.

Ingredients must be free of contamination by chemical residues, microbial toxins, pathogens and mycotoxins.

Raw materials should be as fresh as possible within practical limitations and should be stored under controlled conditions.

Storage facilities must be protected from contamination by insects, rodents, and in particular, wild birds, all of which are potential carriers of disease.

Breeding stock can be fed successfully on mash, crumbled or pelleted feed, as long as good feeding management is practiced.

Provide feed as fresh as possible. The risk of nutrient degradation and mold growth in feed increases as a given feed delivery remains in the farm feed bin.

Alterations to the inclusion levels of specific diet ingredients, feedstuffs, are the major means by which feed manufacture can be optimized in terms of nutrient content, palatability and price.

Raw Materials

Many feed ingredients are suitable for feeding to parent stock. Supply and price will usually determine the choice; however, a few general guidelines may be given.

When comparing cereal sources, corn has been found to give performance advantages in the laying period when compared to wheat. Birds fed corn-based rations have shown improved eggshell quality compared with hens fed wheat-based feeds.

Better eggshell quality leads to improved yield of hatching eggs, less bacterial contamination and improved hatchability and chick quality.

Feed fats and oils should be used at modest levels at all stages. In general, a minimum inclusion of 0.5-1.0% added fat is recommended to reduce dustiness, improve absorption of fat-soluble nutrients, and enhance palatability.

Feed Processing

Breeding stock can be fed successfully on mash, crumbled or pelleted feed, as long as good feeding management is practiced. The feed form is highly dependent on available feed ingredients and feed compounding facilities.

Mash: A good-quality mash extends clean-up time compared to crumble or pellet forms, and therefore allows all birds the opportunity to eat the recommended feed amount. This will support good body-weight development and uniformity. However, mash feed can be inconsistent due to particle segregation of low- and high-density feed ingredients as the feed is transported and conveyed onto the farm. Poor-quality mash (e.g., that with a particle size that is too small) can increase the risk of mash bridging in farm feed bins.

Crumble: A good-quality crumble will support optimal clean-up time compared to mash, ensuring uniform distribution, and offers a lower chance for particle segregation of the dietary ingredients compared to mash. In most situations, an intake of feed is achieved most easily with a crumble.

Pellets: A good-quality pellet is preferred if clean-up time is a concern (e.g., during high environmental temperatures). If floor feeding is applied, a good-quality pellet is critical.

Feed Hygiene (Heat Treatment)

All feed must be considered a potential source of bacterial infection, particularly coliforms and *salmonellae*, and should be decontaminated if total bacterial pathogen control is required. Thermal processing involves treatment with adequate heat in a retention vessel at atmospheric pressure for sufficient time to kill the organism. For parent stock feed, temperature and exposure to heat varies within region and with equipment capability. Feed processing time and temperatures should be established for each production plant. Feed heat treatment is one aspect of protecting parent stock flocks from salmonella. Heat treatment should be considered, along with organic acid treatment or a formaldehyde blend treatment, based on local legislation.

Vaccination for *salmonella* is also a further protective strategy. In combination, these strategies should be sufficient to reduce the mesophilic bacterial counts to less than 10 organisms per gram.

Pelleting alone will not completely eliminate harmful bacteria from feed (although it may not be detectable in routine laboratory tests). Care must be taken not to re-contaminate feed. Critical control points for the prevention of re-contamination include the cooling, storage, and transportation of feed from the feed mill into the feed lines and feeders.

When feeds are heated, consideration should be given to components that may be damaged by heat (e.g., vitamins and amino acids). The vitamin levels recommended in the **Ross Parent Stock Nutrition Specifications** will cover losses from conventional conditioning and pelleting of the feed. However, more severe heat treatment may be required for vitamins and/or amino acid to be fortified. There may also be changes (positive and negative) in nutritional value due to structural changes in the feed.

Finished Feed

The time period for feed to go from the feed mill to being consumed by the breeder flock should be as short as possible. Feed deliveries should be scheduled so that feed does not reside in farm feed bins for excessive periods of time (i.e., >10 days). If feed is

delivered in bags, a rotating schedule of feed stocked is needed. Feed bags should be stored in a dry, clean and vermin-free place, off from the floor and inspected for any damage before given to birds. If damaged bags are found (i.e., wet, moldy, gnawed bags) they should be discarded, and the cause of damage needs to be fixed. This is especially important under conditions of high temperature and humidity, which will accelerate overall feed-quality degradation. By using appropriate mold inhibitor compounds (e.g., propionic acid based mold inhibitors), the risk of mold growth and subsequent mycotoxin production can be reduced.

Quality control is essential. A program of monitoring the quality of finished feed is necessary, which should include both feed mill and farm sampling. It is assumed that feed manufacturing site personnel will take representative feed samples from production runs. At the farm level, it is useful to take and retain feed samples from each feed delivery. In the event flock performance problems occur, these samples are then available for additional analysis to help identify or exclude nutritional issues.

Samples should ideally be taken inside the house from one of the feed hoppers. Target a sample size of approximately 1,000 g (2.2 lb). Place the sample in a sealable plastic bag and store in a cool, dry area until the flock is depleted.

Some of the consequences of not meeting the dietary nutrient specifications are summarized in **Table 31**.

Table 31
Consequences for the laying flock of not meeting the nutrient specifications.

	Effect of Undersupply	Effect of Oversupply
Crude protein	Depends on amino acid levels, but generally results in poor feathering, decreased egg size and number. Poor chick quality from young flocks.	Increased egg size and lower hatchability. Increased metabolic stress during hot weather conditions.
Energy	Body weight, egg size and egg number will decrease unless feed quantity is adjusted.	Excess leads to increased double yolks, oversized eggs and obesity. Late fertility/hatchability suffer.
Lysine, methionine & cystine	Decreased egg size and number.	Excess lysine leads to high egg weights and body weights. In early production, excess lysine could lead to double yolk, peritonitis, prolapse and mortality
Linoleic acid	Decreased egg size.	
Calcium	Poor shell quality.	Reduced availability of nutrients.
Available phosphorous	May impair egg production and hatchability. Reduced bone mineralization in chicks.	Poor shell quality.

Water

Water is the most important nutrient for life. Unlimited, clean, fresh water should be available to birds at all times. However, during times when water intake is naturally low, control of water may help to prevent unnecessary leakage (see *Drinker Management* for more information).

As a general rule, in rear, the ratio of water intake to feed intake is at a minimum 1.6:1 (water: feed) at 21°C (69.8°F), although this will vary with drinker type. In lay, water intake may be expected to be higher than this. Water requirements will vary with feed consumption and will increase with ambient temperature. In some areas, the sodium content in water is high and adjustments in feed formulation need to be made to prevent overconsumption of water. Detailed information about the effect of water temperature on water intake can be found in **Table 2 (Rearing)**, and water quality can be found in the *Health and Biosecurity* section of this Handbook.

KEY POINTS

Failure to achieve production targets can be due to unseen variations in feed ingredient quality and nutrient content.

Quality control of the finished feed both at the feed mill and on the farm, is essential.

Managers should be in constant dialogue with their feed nutritionist and their feed manufacturer to be aware of any changes made to ingredient formulation or nutrient specification.

Section 9: Health and Biosecurity

Health and Biosecurity

Objective

To achieve hygienic conditions within the poultry house and to minimize the effect and prevent the spread of any disease should it occur. To attain optimum performance and bird welfare, and to provide assurance on food safety issues.

Principles

Hygienic conditions within the poultry house are achieved through the implementation of correct biosecurity, cleaning and disinfection, vaccination programs and good management practices (**Figure 120**).

Figure 120
Biosecurity in a breeder farm.

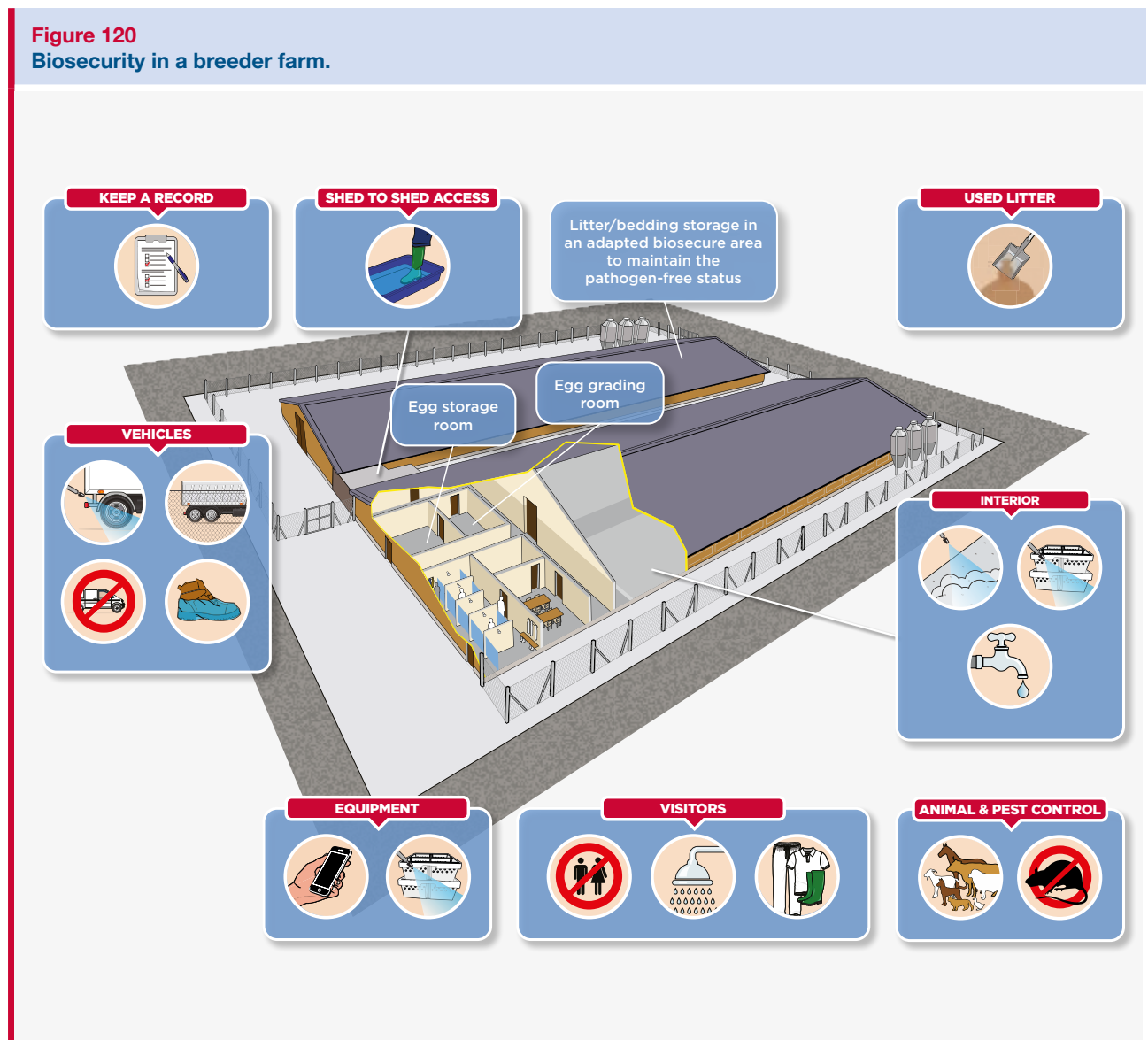

The Relationship Between Management, Disease Expression and Bird Welfare

The incidence and severity of many diseases and bird welfare are affected by the circumstances experienced by the birds. The management systems described in this Handbook are designed to maximize production by optimizing bird welfare in parent stock. Where it may prove impossible to exclude a pathogen in a particular situation, the commercial effects of a disease may be minimized by reducing the challenges deriving from other sources.

The overall balance of correctly applied management factors is important as many factors interact with each other to increase the severity of symptoms seen as a result of infection. When defining control measures for disease, and therefore bird welfare, it is important to take into account the possible incidence of conditions such as:

Poor feed management and other factors that can precipitate problems of staphylococcal or *E.coli* infections such as synovitis.

Conditions such as overstimulation of birds can be associated with peritonitis, increased double-yolked eggs, erratic oviposition and defective egg syndrome (EODES), and polyclonal *E.coli* septicaemia at point of lay. See **Infectious Diseases and Metabolic Syndromes Impacting Broiler Breeders** for more information.

Management of the water supply to reduce unnecessary water leakage.

Stocking density, biosecurity, vaccination and control of immunosuppressive infections e.g., Marek's disease virus (MDV), reovirus, infectious bursal disease (IBD), chicken anaemia virus (CAV) and some mycotoxins, can markedly affect the severity of other diseases.

Hygiene Management

Strict operation of a comprehensive program of hygiene management is essential if proper attention is to be given to:

Site biosecurity.

Site cleaning.

Biosecurity

A strict biosecurity program must be in place to minimize the risk posed by the introduction of disease organisms into the chicken flock.

Farm Location/Construction

Ideally, the farm should be located in an isolated area, at least 3.2 km (2 miles) distance from the nearest poultry or other livestock facilities that may contaminate the farm. Facilities should be built away from rivers and ponds to prevent exposure to wild birds.

Build the farm away from major roadways that may be used to transport poultry.

Fence the perimeter of the farm to prevent unwanted visitors.

Test the water source for mineral, bacterial and chemical contamination on a regular basis as water table/aquifers can change due to season, weather and agricultural activity.

The design and construction of the houses should prevent wild birds and rodents from entering the building. A concrete foundation and floor will prevent rodents from burrowing into the house and allow for easier removal of pathogens.

Conventional broiler breeder houses should ideally be facing in an east-west direction. This helps to reduce the amount of direct sunlight that could impact the birds.

Clear and level an area 15 m (50 ft) around all houses so that grass can be cut quickly and easily. Gravel or pebbles are easier to maintain than grass, but it is preferred to lay a concrete apron around the perimeter of the house.

Preventing Diseases Transmitted by Humans

Minimize the number of visitors and prevent unauthorized access to the farm **by locking the entry gates** and posting no trespassing/no visitors signs.

All people entering the farm should follow a biosecurity procedure. The requirement that all workers and visitors shower and use clean farm clothes is the best way to prevent cross contamination between facilities.

Maintain a record of visitors, including name, company, purpose of visit, previous farm visited and next farm to be visited. Depending on the status of the flocks visited, it may be necessary to have a minimum of 72 hours of no contact with poultry.

When entering and leaving each poultry house, workers and visitors must wash and sanitize their hands and change boots.

Tools and equipment carried into the house are a potential source of disease. Only necessary items should be taken into the house and only after they have been properly cleaned and disinfected.

If supervisory personnel are not able to avoid visiting more than one farm per day, they should visit the youngest flocks first. If an infectious disease is suspected, all visits should be stopped immediately.

Preventing Diseases Transmitted by Animals

Whenever possible, place the farm on an “all in/all out” placement cycle. Multiple-age chickens on the same site provide a reservoir for disease organisms.

Downtime between flocks will reduce contamination of the farm. Downtime is defined as the time between completion of the cleaning/disinfection process and placing the next flock. A minimum downtime of 3 weeks between flocks is recommended, but the exact downtime required will depend on the size of the farm (a bigger farm may take longer to clean/disinfect).

Keep all vegetation cut 15 m (50 ft) away from the buildings to provide an entry barrier to rodents and wild animals.

Do not leave equipment, building materials or litter lying around. This will reduce cover for rodents and wild animals.

Clean up feed spills as soon as they occur.

Store litter material in bags or inside a storage building or bin.

Keep wild birds and pets out of all buildings.

Maintain an effective rodent control program (**Figure 121**). Baiting programs are most effective when followed continuously.

Where appropriate, additional anti-rodent barriers in the form of an electric rodent fence or metal/concrete fence could be established around farm/house.

Use an integrated pest management program, including mechanical, biological and chemical controls.

OTHER USEFUL INFORMATION AVAILABLE

- Best Practice on the Farm: Fly Control*
- Best Practice in the Breeder House: Biosecurity*
- Aviagen Poster: Biosecurity*
- Best Practice on the Farm: Rodent Control*
- Best Practice on the Farm: Darkling Beetle Control*

Figure 121

Example of a rodent baiting plan. The actual number of baiting points placed must be appropriate to the risk. Stations should be spaced 15-23 m (50-75 ft) apart, with a maximum distance between stations of 30 m (100 ft). A full explanation of the diagram can be accessed from *Best Practice on the farm: Rodent control*.

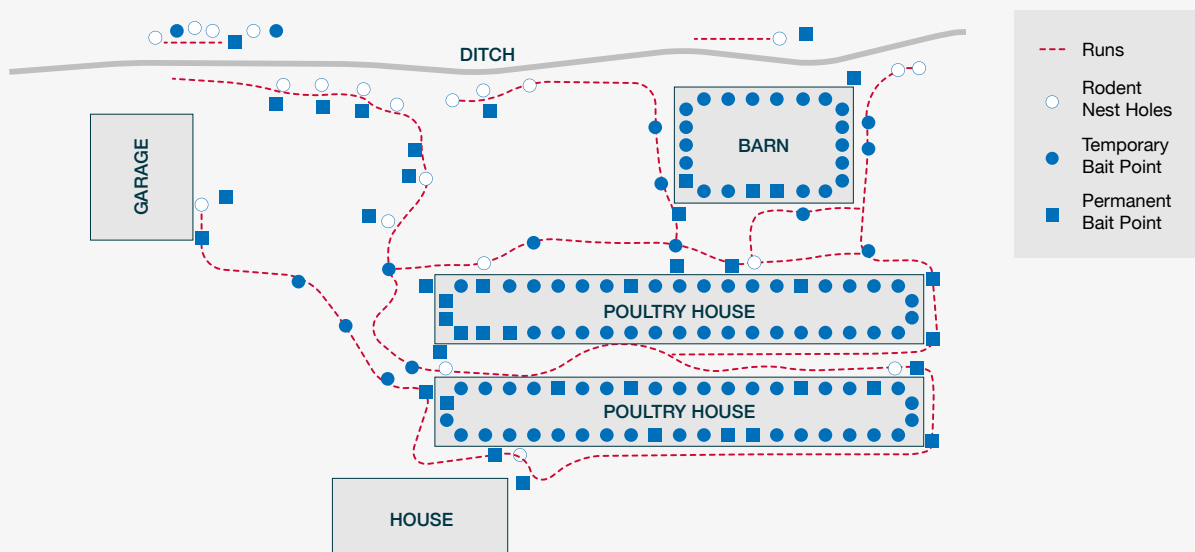

Site Cleaning

It is important to properly clean and disinfect the poultry house, service areas and surroundings so that all potential poultry and human pathogens are removed and the numbers of residual bacteria, viruses, parasites and insects are minimized between flocks. This will minimize any effect on health, welfare and performance on the subsequent flock.

House Design

The house and equipment should be designed to enable easy, effective cleaning. Ideally, the poultry house should have concrete floors, washable (i.e., impervious) walls and ceilings, accessible ventilation ducts and no internal pillars or ledges. Earth floors are incredibly difficult to clean and disinfect adequately. An area of concrete or gravel extending to a width of 1-3 m (3-10 ft) surrounding the house can discourage the entry of rodents and provide an area for washing and storing removable equipment.

Procedures

Planning: A successful clean-out requires that all operations are effectively carried out on time. Clean-out is an opportunity to carry out routine and/or preventative maintenance on the farm and this should be planned into the cleaning and disinfection program. A plan detailing dates, times, labor and equipment requirements should be drawn up prior to depleting the farm. This will ensure that all tasks can be completed successfully.

Insect Control: Insects are vectors of disease and must be destroyed before they migrate into woodwork or other materials. As soon as the flock has been removed from the house and while the building is still warm, the litter, equipment and all surfaces should be sprayed with a locally recommended insecticide. Alternatively, the house may be treated with an approved insecticide within 2 weeks prior to depletion. A second treatment with insecticide should be completed before fumigation. Products used for fumigation should meet local legislation.

Remove dust: All dust, debris and cobwebs must be removed from fan shafts, beams and exposed areas of unrolled curtains in open-sided houses, ledges and stonework. For best results, use a brush so that the dust falls onto the litter.

Pre-spray: A knapsack or low-pressure sprayer should be used to spray a detergent solution throughout the inside of the house, from ceiling to floor, to dampen dust before litter and equipment are removed. In open-sided houses, the curtains should be closed first.

Remove equipment: All equipment and fittings (drinkers, feeders, perches, nest-boxes, dividing pens, etc.) should be removed from the building and placed on the external concrete area. It may not be desirable to remove automatic nest boxes, and alternative strategies may be required.

Remove litter: All litter and debris must be removed from within the house. Trailers or rubbish skips (dumpsters) should be placed inside the house and filled with soiled litter. The full trailer or dumpster should be covered before removal to prevent dust and debris from blowing around outside. Vehicle wheels must be disinfected with spray upon leaving the house.

Litter disposal: Litter must not be stored on the farm for fertilizer or spread on land adjacent to the farm. It must be removed to a distance of at least 3.2 km (2 miles) from the farm, and disposed of in accordance with local government regulations in one of the following ways:

Spread on arable crop land and plowed within 1 week.

Buried in an approved landfill site, quarry or hole in the ground (in some areas this is not allowed).

Stacked and allowed to heat (i.e., compost) for at least 1 month before being spread on livestock grazing land.

Incinerated (in some areas this is not allowed).

Burning litter as a biofuel for electricity production.

Washing: Before washing starts, check that all electricity in the house has been switched off. A pressure washer with foam detergent should be used to remove the remaining dirt and debris from the house and equipment. Many different industrial detergents are available and manufacturer's instructions should always be followed. The detergent must be compatible with the disinfectant that will be used to disinfect the house later on.

After washing with detergent, rinse the house and equipment with clean fresh water, again using a pressure washer. Hot water should be used for cleaning and excess floor water removed using a squeegee (a rubber-edged blade set on a handle). Wastewater should be disposed of hygienically to avoid any re-contamination of the houses. All equipment removed from the house must also be soaked, washed and rinsed. Cleaned equipment should then be stored under cover.

Inside the house, particular attention should be paid to the following places:

Fan boxes.
Fan shafts.
Fans.
Ventilation grills.
Tops of beams.
Ledges.
Water pipes.
Feed lines.
Air inlets.
Nest boxes.
Augers.
Fumigation rooms.
Egg rooms.

In order to ensure that inaccessible areas are properly washed, it is recommended that portable scaffolding and portable lights are used. The outside of the building must also be washed and special attention given to:

Air inlets.
Around fan exhausts
Gutters.
Concrete pathways.
Silos/ feed bins.
Scales.

In open-sided housing, the inside and outside of curtains must be washed. Any items that cannot be washed (e.g., polythene and cardboard) must be destroyed.

When washing is complete, there should be no dirt, dust, debris or litter present. Proper washing requires time and attention to detail.

Staff facilities should also be thoroughly cleaned at this stage. The egg store should be washed out and disinfected and humidifiers dismantled, serviced and cleaned prior to disinfection.

Cleaning Water and Feed Systems

All equipment within the house must be thoroughly cleansed and disinfected. After cleansing, it is essential that the equipment is stored under cover. The procedure for cleaning the water system is as follows:

Drain pipes and header tanks.
Clean the nipple regulator.
Flush lines with clean water.
Scrub header tanks to remove scale and biofilm deposit and drain to the exterior of the house.
Refill tank with fresh water and add an approved water sanitizer.
Run the sanitizer solution through the drinker lines from the header tank, ensuring there are no air locks. Make sure the sanitizer is approved for use with the drinker equipment and is used at the correct dilution.
Make up header tank to normal operating level with additional sanitizer solution at appropriate strength. Replace lid. Allow disinfectant to remain for a minimum of 4 hours.
Drain and rinse with fresh water.
Refill with fresh water prior to chick arrival.
Water sample should be analyzed for total viable count (TVC).

Biofilms will form inside water pipes, and regular treatment to remove them is needed to prevent decreased water flow and bacterial contamination of drinking water. Pipe material will influence the rate of biofilm formation. For example, biofilm tends to form quicker on alkathene (plastic) pipes and plastic tanks. The use of vitamin and mineral treatments in drinking water can increase biofilm and aggregation of materials to the pipes etc. Physical cleaning of the inside of pipes to remove biofilms is not always possible; therefore, between flock biofilms can be removed using peroxygen compounds. These need to be flushed completely from the drinking system before birds drink. Cleaning may need to include acid scrubbing where the water mineral content (especially calcium or iron) is high. Metal pipes can be cleaned the same way, but corrosion can cause leaks. Water treatment before use should be considered for high mineral waters.

Evaporative cooling and fogging systems can be sanitized at cleanout using a bi-guanide sanitizer. Bi-guanides can also be used during production to ensure that the water used in these systems contains minimal bacteria, reducing bacterial spread into the poultry house.

The procedure for cleaning the feed system is as follows:

Run auger systems out and ensure no feed is left.

Empty, wash and disinfect all feeding equipment (e.g., feed bins, track, chain and hanging feeders).

Empty bulk bins and connecting pipes and brush out where possible. Clean out and seal all openings.

Ensure feed lines and equipment are allowed to dry properly if wet washed.

Fumigate wherever possible.

Repairs and Maintenance

A clean, empty house provides the ideal opportunity for structural repairs and maintenance to be completed. Once the house is empty, pay attention to the following tasks:

Repair cracks in the floor with concrete/cement.

Repair pointing (mortar joints) and cement rendering on wall structures.

Repair or replace damaged walls, curtains and roof/ceilings.

Carry out painting or whitewashing where required.

Ensure that all doors shut tightly.

Disinfection

Disinfection should not take place until the whole building (including the external area) is thoroughly cleaned and dried and all repairs complete. Disinfectants are ineffective in the presence of dirt and organic matter.

Disinfectants which are approved by regulatory agencies for use against specific poultry pathogens of both bacterial and viral origin, are most likely to be effective. Manufacturers' instructions must be followed at all times.

Disinfectants should be applied using either a pressure-washer or a backpack sprayer. Foam disinfectants allow greater contact time, increasing the efficiency of disinfection. Heating houses to high temperatures after sealing can enhance disinfection.

Most disinfectants are not effective against sporulated coccidial oocysts. However, where there is a need to treat the environment to try to remove a background challenge of oocysts, other treatments that can be used, although these are not always effective. For concrete floors, the use of flaming, salt or specific disinfectants based on phenolic compounds can be beneficial. For earth floors, salt can also be used. Ammonia is very effective against coccidial oocysts, but in most parts of the world the use of ammonia is prohibited because of concerns about health and safety.

Formalin Fumigation

Where formalin fumigation is permitted, fumigation should be undertaken as soon as possible after disinfection has been completed. Surfaces should be damp and the houses warmed to a minimum of 21°C (69.8°F). Fumigation is ineffective at lower temperatures and at RH of less than 65%.

Doors, fans, ventilation grills and windows must be sealed. Manufacturers' instructions concerning the use of fumigants must be followed. After fumigation, the house must remain sealed for 24 hours with NO ENTRY signs clearly displayed. The house must be thoroughly ventilated before anyone enters.

After bedding material has been spread, all the fumigation procedures described above should be repeated.

Fumigation is hazardous to animals and humans and is not permitted in all countries. Where permitted, it must be conducted by trained personnel following local safety legislation and guidelines. Personal welfare, and health and safety guidelines must also be followed, and protective clothing (i.e., respirators, eye shields and gloves) must be worn. At least 2 people must be present in case of emergency.

In some situations, it may be necessary to use floor treatments as well. Some common floor treatments, their doses and indications are given in **Table 32**.

Table 32
Common floor treatments for poultry houses.
See *Best practice on the farm: Darkling Beetle Control* for more information.

Compound	Application Rate		Purpose
	kg/m ²	lbs/100 ft ²	
Boric acid	As necessary	As necessary	Kills darkling beetles
Salt (NaCl)	0.25	5	Reduces clostridium counts
Sulphur powder	0.01	2	Lowers pH
Lime (calcium oxide/hydroxide)	As necessary	As necessary	Disinfection

Follow manufacturers' guidelines for safety and proper mixing of insecticides, and rotate on a recommended cycle.

Cleaning External Areas

It is vital that external areas are also cleaned thoroughly. Ideally, poultry houses should be surrounded by an area of concrete or gravel, 1-3 m (3-10 ft) in width. Where this does not exist, the area around the house must:

- Be free of vegetation.
- Be free of unused machinery/equipment.
- Have an even, level surface.
- Be well drained and free of any standing water.

Particular attention should be paid to cleaning and disinfection of the following areas:

- Under ventilator and extractor fans.
- Under the feed bins.
- Storage rooms.
- Access routes.
- Door surrounds.

All concrete areas should be washed and disinfected as thoroughly as the inside of the house.

Evaluation of Farm Cleaning and Disinfection Efficiency

It is essential to monitor the efficiency and cost of cleaning out and disinfection. The effectiveness of cleaning is commonly evaluated by completing *Salmonella* isolations. Analyzing samples for TVC may also be useful. Monitoring trends in *Salmonella* /TVCs will allow continuous improvement in farm hygiene and comparisons to different cleaning and disinfection methods to be made.

Bioluminescence technology identifies and measures the adenosin triphosphate (known as ATP). ATP is found in all plant, animals and microorganisms; its presence in cleaned surfaces can help assess how well the cleaning procedure was executed.

When disinfection has been carried out effectively, the sampling procedure should not isolate any *Salmonella* species. For a detailed description of where to sample and recommendations of how many samples to take, please consult your Avigen veterinarian.

OTHER USEFUL INFORMATION AVAILABLE



Avigen Poster: Cleaning and Disinfection

KEY POINTS

- A clear and implemented program of hygiene management should be in place for site biosecurity, and site cleaning and disinfection.
- Adequate biosecurity should prevent disease from entering the farm via both humans and animals.
- Site cleaning and disinfection must cover both the interior and exterior of the house, all equipment and external house areas, as well as the feeding and drinking systems.
- Reduce pathogen carryover by allowing adequate downtime between flocks for cleaning.
- Appropriate planning and evaluation of the cleaning and disinfection procedures must be in place.

OTHER USEFUL INFORMATION AVAILABLE

- 

Broiler Breeder Management How To: Prepare the Breeder House for Cleaning and Disinfection after Depletion
- 

Broiler Breeder Management How To: Clean the Breeder House after Depletion
- 

Broiler Breeder Management How To: Disinfect the Breeder House after Depletion
- 

Broiler Breeder Management How To: Clean the Feeding System after Depletion
- 

Broiler Breeder Management How To: Clean the Water System after Depletion
- 

Broiler Breeder Management How To: Monitor the Effectiveness of Cleaning and Disinfection

Water Quality

Water should be clear with no organic or suspended matter. It should be monitored to ensure purity and freedom from pathogens. Specifically, water should be free from *Pseudomonas* species and *E. coli*. There should be no more than 1 coliform/ml in any one sample and consecutive water samples must not contain coliforms in more than 5% of samples taken.

Water quality criteria for poultry are given in **Table 33**. If water comes from a main supply, there are usually less water quality issues. Water from wells however, may have excessive nitrate levels and high bacterial counts due to run-off from fertilized fields. Where bacterial counts are high, the cause should be established and rectified as soon as possible. Chlorination to give between 3 and 5 ppm free chlorine at the drinker level is usually effective in controlling bacteria, but this is dependent on the type of chlorine component used.

Ultraviolet light (applied at the point of entry to the house) can also be used to disinfect water. Manufacturers' guidelines should be followed in establishing this procedure.

Hard water or water with high levels of iron (>3 mg/L) can cause blockages in drinker valves and pipes. Sediment will also block pipes, and where this is a problem, water should be filtered using a 40-50 micron (µm) filter. Water containing high levels of iron can support bacterial growth.

A total water quality test should be done at least once a year and more often if there are perceived water quality issues or performance problems. After house cleaning and prior to chick delivery, water should be sampled for bacterial contamination at the source, the storage tank and the drinker points.

It is good practice to routinely complete a visual check of the water supply to a flock. This is done by running a sample of water out of the end of each nipple line and making a visual check for clarity. If water lines and water sanitation are not adequate, there will be a high level of particulate matter in the water, visible to the naked eye. Action should be taken to rectify this issue.

Use of an approved water sanitizer on a routine basis throughout the flock life is also recommended. Measuring the oxidation-reduction potential (ORP) of water is a good way of determining if the water sanitation program is working (**Figure 122**). An ideal ORP reading should be between 650 and 800 mV.

It is also good practice to disinfect water lines once a month during the life of the flock and flush them a minimum of once a week to maintain good water quality.

Figure 122
An example of an ORP meter.



✓ KEY POINTS

Good water quality is essential for bird health and welfare.

Water quality should be routinely tested for bacterial and mineral contamination, and necessary corrective action taken based on the test results.

i OTHER USEFUL INFORMATION AVAILABLE



Best Practice on the Farm: Water Chlorination during Production



Aviagen Brief: Water Line Sanitation

Table 33
Water quality criteria for poultry.

Criteria	Concentration (ppm)	Comments
Total Dissolved	<1000	Good.
Solids (TDS)	1000-3000	Satisfactory: Wet droppings may result at the upper limit.
	3000-5000	Poor: Wet droppings, reduced water intake, poor growth and increased mortality.
	>5000	Unsatisfactory.
Hardness	<100 Soft	Good: No problems.
	>100 Hard	Satisfactory: No problem for poultry but can interfere with effectiveness of soap and many disinfectants and medications administered via water.
pH	<6	Poor: Performance problem, corrosion of water system.
	6.0-6.4	Poor: Potential problems.
	6.5-8.5	Satisfactory: Recommended for poultry.
	>8.6	Unsatisfactory.
Sulfates	50-200	Satisfactory: May have a laxative effect if Na or Mg >50 ppm.
	200-250	Maximum desirable level.
	250-500	May have a laxative effect.
	500-1000	Poor: Laxative effect, but birds may adjust, may interfere with copper absorption, additive laxative effect with chlorides.
	>1000	Unsatisfactory: Increased water intake and wet droppings, health hazard for the young birds.
Chloride	250	Satisfactory: Highest desirable level, levels as low as 14 ppm may cause problems if sodium is higher than 50 ppm.
	500	Maximum desirable level.
	>500	Unsatisfactory: Laxative effect, wet droppings, reduced feed intake, increases water intake.
Potassium	<300	Good: No problems.
	>300	Satisfactory: Depends on the alkalinity and pH.
Magnesium	50-125	Satisfactory: If sulfate level >50ppm magnesium sulfate (laxative) will form.
	>125	Laxative effect with intestinal irritation.
	350	Maximum desirable level.
Nitrate Nitrogen	10	Maximum (sometimes levels of 3 mg/L will affect performance).
Nitrates	trace	Satisfactory.
	>trace	Unsatisfactory: Health hazard (indicates organic material fecal contamination).
Iron	<0.3	Satisfactory.
	>0.3	Unsatisfactory: Growth of iron bacteria (clogs water system and bad odor).
Fluoride	2	Maximum desirable level.
	>40	Unsatisfactory: Causes soft bones.
Bacterial Coliforms	0 cfu/ml	Ideal: Levels above indicates fecal contaminations.
Calcium	600	Maximum level.
Sodium	50-300	Satisfactory: Generally no problem; however, may cause loose droppings if sulfates >50 ppm or if chloride >14 ppm.

Dead Bird Disposal

Table 34
Advantages and disadvantages of common methods of dead bird disposal.

Method	Advantages	Disadvantages
Incineration	<p>Does not contaminate ground water or produce cross-contamination with other birds when facilities are properly maintained.</p> <p>Little by-product to remove from the farm.</p>	<p>Tends to be more expensive and may produce air pollution.</p> <p>Environmental and regulatory sensitivities.</p> <p>Must ensure sufficient capacity for future farm needs.</p> <p>Must ensure that carcasses are burned completely to white ash.</p>
Composting	<p>Economical and if designed and managed properly, will not contaminate ground water or air.</p>	<p>If not done to the correct temperature, live viable diseases may be present on the farm.</p>
Rendering	<p>There is no on-farm disposal of dead birds.</p> <p>Requires minimal capital investment.</p> <p>Produces minimal environmental contamination.</p> <p>Materials can be turned into feed ingredients for other appropriate livestock.</p>	<p>Requires freezers to keep birds from decomposing during storage.</p> <p>Requires intense biosecurity measures to ensure that personnel do not transfer diseases from the rendering plant to the farm.</p>

KEY POINT

Dead birds should be disposed of in a manner that avoids contamination of the environment, prevents cross-contamination with other poultry, is not a nuisance to neighbors and is in accordance with local legislation.

Health Management

Disease Control

Good management practices and high standards of biosecurity will prevent many poultry diseases. One of the first signs of a disease challenge is a decrease in water or feed intake (i.e., increased feed clean-up time). It is, therefore, good management practice to keep daily records of feed and water consumption. If a problem is suspected, immediate action should be taken by sending birds for post-mortem examination and contacting the flock veterinary adviser. Early appropriate treatment of a disease incident may minimize the adverse effects on the birds' health, welfare, and reproductive performance, and also minimize the effects on the health, welfare and quality of the progeny.

Records are an important means of providing objective data for the investigation of flock problems. Vaccinations, route of application, batch numbers, medications, observations and disease investigation results should all be recorded in flock diaries.

Vaccination

Vaccination provides the bird with exposure to a particular form of the infectious organism (antigen) to promote a good immunological response. When administered correctly, this will actively protect the bird from subsequent field challenge and/or provide passive protection, via maternally derived antibodies, to the progeny.

Vaccination Programs

Common diseases, including MDV, Newcastle disease (ND), avian encephalomyelitis (AE), infectious bronchitis (IB), IBD (e.g., Gumboro disease) and CAV, among others, should be routinely considered when a vaccination program is prepared. However, vaccination requirements will vary depending on local challenges, vaccine availability and local regulations. A suitable program should be devised by local flock veterinary advisers, who will use their detailed knowledge of the disease prevalence and intensity in a specific country, area or site.

Dyes, vaccine titers, and the elimination of clinical signs of disease can be used to assess the effectiveness of vaccines and vaccine delivery. It should be noted that titers are not always correlated with protection but are still useful when trying to evaluate the vaccination program. Excessive vaccination may lead to poor titers and/or CVs of titers. Overly aggressive vaccination programs can also impact growing chickens, especially from 10-15 weeks of age (so try to minimize bird handling when possible). The field situation should also be considered in evaluating the effectiveness of a vaccination program. Hygiene and maintenance of vaccination equipment are important, and it is important to follow the manufacturer's vaccine instructions on methods of administration to get optimum results.

Vaccination can help prevent disease but is not a direct replacement for good biosecurity. Protection against each individual disease should be assessed when devising a suitable control strategy. For instance, "all in/all out" policies provide good protection against fowl coryza and infectious laryngotracheitis (ILT), so vaccination is unnecessary in some instances. The vaccines used in the vaccination program should be limited to those that are absolutely necessary as this will reduce costs, have less impact on the birds, and provide greater opportunity to maximize the overall vaccine response. Vaccines should be obtained from reputable manufacturers only. Always use the full dosage and do not dilute vaccine doses. Properly discard vaccine bottles and vials after use.

Types of Vaccine

Vaccines for poultry are in 2 basic forms, killed (inactivated) and live. In some vaccination programs, they may be combined to promote maximum immunological response. Each type of vaccine has specific uses and advantages.

Killed Vaccines: These are composed of inactivated organisms (antigens), usually combined with an oil emulsion or aluminum hydroxide adjuvant. The adjuvant helps increase the response to an antigen by the bird's immune system over a longer period of time.

Killed vaccines may contain multiple inactivated antigens to several poultry diseases. Killed vaccines are administered to individual birds by injection either subcutaneously or intramuscularly.

Live Vaccines: These consist of infectious organisms of the actual poultry disease. However, the organisms will have been substantially modified (attenuated) so that when they multiply within the bird, they do not cause disease but do promote an immune response. Some vaccines are exceptional in that they are not attenuated and therefore require care before introduction into a vaccination program (e.g., some coccidiosis vaccines).

In principle, when several live vaccinations are given for a specific disease, the most attenuated form of the vaccine is normally given first, followed by a less attenuated form where available. This principle is commonly utilized for ND live vaccination when pathogenic field challenge is anticipated.

Attenuated live vaccines are usually administered to the flock via drinking water, spray and eye drop application or wing-web application. Occasionally, live vaccinations are given by injection (e.g., MDV vaccine.)

Live bacterial vaccines for *Salmonella* and *Mycoplasma* are now available and may have a place in some production systems. Some competitive exclusion products (consisting of healthy bacteria normally found in the gastrointestinal tract, which help to minimize colonization of undesirable harmful bacteria such as *Salmonella*) can also have a place in protecting parent stock from *Salmonella* and possibly other infections early in life, or after antibiotic treatment.

Combined Live and Killed Vaccinations

The most effective method of achieving high and uniform levels of antibody to a disease is by the use of one or more live vaccines containing the specific antigen, followed by injection of the killed antigen. The live vaccines prime the bird's immune system and facilitate a very good antibody response when the killed antigen is presented. This type of vaccination program is used routinely for many diseases such as IB, IBD, Reovirus and ND. It ensures active protection of the bird and provision of high and uniform levels of maternally derived antibody. This allows passive protection of the progeny.

Specific Vaccination Programs

Vaccination programs must be designed according to local disease challenges and maternal antibody requirements in broilers. A suitable vaccination program should be established by the local veterinarian responsible for the health status of the operation.

Aviagen veterinarians are available to provide suggestions or supportive information. **Table 35** gives some essential factors for the successful vaccination of parent stock.

Marek's Disease Virus

All parent stock should receive MDV vaccine at day-old or in ovo at the hatchery. There are three different serotypes of live MDV vaccines available. Which vaccine(s) should be administered is dependent on the level of challenge in an area. The two most common serotypes are HVT (Turkey herpes virus), which is a serotype 3 and Rispens, which is a serotype 1. Rispens is usually used in any high-challenge areas, often in combination with other MDV vaccine serotypes. Combinations of different MDV serotypes are often given for best protection depending on the challenge in the area the birds are to be placed.

Coccidiosis

Control of coccidiosis is important in broiler breeders. Vaccination of parent stock with live coccidiosis vaccines at the hatchery is now the method of choice for controlling this condition. In some cases birds are vaccinated on farm. Care should be taken to prevent subsequent exposure of the flock to substances with anticoccidial activity (except where recommended by the vaccine manufacturer). Post-vaccination management ensuring

oocyst sporulation and re-infection is necessary to improve vaccine efficiency. Birds should be monitored by routine necropsies at specific ages (depending on the vaccine) to monitor for excessive reaction. Controlling vaccine reactions through good management and vaccine application is very important for good bird performance. Coccidiosis can also be controlled by the use of in-feed anti-coccidials which depend on local regulation. It should be noted that use of anticoccidials is generally discouraged for in-lay birds due to potential issues with toxicity. The use of oocysts per gram counts (OPG) from fecal sampling can also be useful in monitoring the effectiveness of a coccidiosis vaccination program.



OTHER USEFUL INFORMATION AVAILABLE



Aviagen Brief: Coccidiosis Control in Broiler Breeders with the use of Vaccines

Worm (Helminth) Control

It is important to monitor and control the internal worm burden (helminth parasites) to which birds are exposed. A common program is for birds to receive 2-5 doses of an anthelmintic drug treatment during the rearing

Table 35
Factors for a successful vaccination program.

Vaccination Program(s) Design	Vaccine Administration	Vaccine Effectiveness
<p>Programs must be based on veterinary advice tailored to specific local and regional challenges established by health surveys and laboratory analyses.</p> <p>Carefully select single or combined vaccines according to age and health status of flocks.</p> <p>Vaccination must result in the development of consistent levels of immunity while minimizing potential adverse effects.</p> <p>Breeder programs should provide adequate and uniform levels of maternal antibodies to protect chicks against several viral diseases during the first weeks of life.</p>	<p>Follow manufacturer's recommendations for product handling and method of administration.</p> <p>Properly train vaccine administrators to handle and administer vaccines.</p> <p>Maintain vaccination records.</p> <p>When live vaccines are given in chlorinated water, stop chlorination a minimum of 24 hours prior to vaccination. Chlorine can reduce vaccine titer or cause inactivation.</p>	<p>Seek veterinary advice prior to vaccinating sick or distressed birds.</p> <p>Periodic and efficient house cleaning followed by placement of new litter material reduces the concentration of pathogens in the environment.</p> <p>Adequate downtime between flocks helps to reduce the build-up of normal house pathogens that can affect flock performance.</p> <p>Regular audits of vaccine handling, administration techniques and post-vaccinal responses are critical to control challenges and improve performance.</p> <p>Ventilation and management should be optimized post-vaccination, especially during times of vaccine-induced reaction.</p>

Maternal antibodies may interfere with the chick's response to some vaccine strains. Levels of maternal antibodies in broilers will decline as the breeder source flock ages.

period where required. Monitoring the efficiency of the control program through routine post-mortem examination of birds can determine the necessity for any additional anthelmintic treatments. Many anthelmintics should be used with caution and should be used under manufacturer's recommendation in production as they might have negative effects on egg production and/or egg quality and fertility.

Salmonella and Feed Hygiene

Salmonella infection through contaminated feed represents a major threat to bird health. The risk of contaminated feed can be minimized by thermal processing of the feed and/or addition of feed additives with antimicrobial activity. Monitoring of raw materials will provide information about the degree of challenge coming through the ingredients into the diets.

Raw materials of animal origin and processed vegetable proteins are at high risk of *Salmonella* contamination and their source and use in feeds for parent stock should be considered carefully.

Thermal processing of feed (e.g., conditioning, extending, pelleting) is used frequently to reduce bacterial contamination. An ideal goal is less than 10 enterobacteriaceae per gram of feed.







Antibiotics

Antibiotic administration must be for therapeutic use only as a tool to treat infections, avoid pain and suffering and preserve the welfare of the flocks. Antibiotics should be used only under the direct supervision of a veterinarian and records of all prescriptions should be kept.

✓ KEY POINTS

- Good management and biosecurity will prevent many poultry diseases.**
- Monitor feed and water intake for the first signs of a disease challenge.**
- Respond promptly to any signs of a disease challenge by completing post-mortem examinations and contacting the local veterinarian.**
- Vaccination alone cannot protect flocks against overwhelming disease challenges and poor management.**
- Vaccination is most effective when disease challenges are minimized through well-designed biosecurity and management programs.**
- Vaccination should be based on local disease challenges and availability of vaccine.**
- Monitor and control worm burden.**
- Salmonella* infection via feed is a threat to bird health. Heat treatment and monitoring of raw materials will minimize the risk of contamination.**
- Only use antibiotics to treat disease and with veterinary supervision.**
- Keep records and monitor flock health.**

i OTHER USEFUL INFORMATION AVAILABLE

 <p>Marek's Disease Virus</p>	 <p>Ross Note: Treatment of Intestinal Worms in Broiler Breeders</p>
 <p>Aviagen Brief: Marek's Disease Control in Broiler Breeders</p>	 <p>Ross Note: Feed Sanitation</p>
 <p>Ross Note: Bacterin Usage</p>	 <p>Aviagen Brief: Best Practice Management in the Absence of Antibiotics at the Hatchery</p>

Health Monitoring Programs

Health monitoring programs have two purposes:

1. To confirm freedom from specific pathogens that can adversely affect the health, welfare and performance of parent stock and the health, welfare and quality of the progeny (broilers).
2. To identify the presence of disease at an early stage so that corrective measures can be implemented to minimize adverse effects either to the flock or the progeny.

Routine necropsy of mortality and regular laboratory monitoring of the flock will help develop an understanding of the flock's health status. When health problems are seen or suspected, veterinary advice should be sought immediately.

It is important to keep up-to-date with local and regional health concerns and be aware of any potential disease challenges.

Salmonella

Salmonella pullorum and *S. gallinarum* are strains that are specific to poultry. Control is monitored by detecting the presence of specific antibodies in blood using an agglutination test. This test can be conducted either on the farm using whole blood or in the laboratory using serum. Many countries have official programs for the control and eradication of both *S. pullorum* and *S. gallinarum*. Both commercial and government supplies of a specific antigen are available in many countries. The absence of these infections can also be monitored by microbiological surveys of the progeny and hatcheries. The presence of *Salmonellae* is usually detected by bacteriological examination of the bird, the environment and the product as it proceeds through the hatchery. Many *Salmonellae* can affect both birds and humans (zoonosis). *S. enteritidis* and *S. typhimurium* are of particular importance and can readily be transmitted vertically to the broiler progeny. However, specific commercial ELISA tests for *S. enteritidis* and *S. typhimurium* are available and can be used in a similar manner to the agglutination test for *S. pullorum* and *S. gallinarum* to detect specific antibodies in serum. Cull birds, cloacal swabs, fresh cecal droppings, litter, drag swabs/ shoe covers and dust samples have all been used to monitor flocks for the presence of *Salmonellae*. Hatchery samples include dead-in-shell, cull chicks, hatcher tray papers (where available), chick box liners and hatchery fluff. Samples can be pooled, usually in tens, to facilitate practical processing through the laboratory. Many countries have official programs that include detailed detection methods and schedules for *Salmonellae* monitoring and eradication in poultry flocks.

Mycoplasma

Blood samples taken from parent flocks should be monitored routinely for both *Mycoplasma gallisepticum* and *Mycoplasma synoviae* using the rapid serum agglutination test (RSAT) or specific, single or combined commercial enzyme linked immunosorbent assay (ELISA) tests. Confirmation can be conducted by polymerase chain reaction (PCR) and/or culture. It is possible to get some false positive results with RSAT and ELISA tests, especially when monitoring day-old chicks.



OTHER USEFUL INFORMATION AVAILABLE



Ross Note: Mycoplasmosis Prevention and Control in Broiler Breeders and Broilers

Other Diseases

Serological monitoring for the presence of other diseases can be carried out routinely, or as is more common, following clinical signs and/or a drop in production. Serological monitoring for diagnostic purposes can include those diseases for which flocks have been previously vaccinated (e.g., ND, IB). Field challenge is suggested when a higher antibody response than normal has occurred in the flock.

Sampling for the Presence of Disease

Monitoring for most diseases in a population should be designed to detect a prevalence of at least 5%, with a 95% confidence. For population sizes that normally apply to broiler parent flocks (i.e., >500 birds), approximately 60 samples should be taken when monitoring each flock. Traditionally, a higher level of monitoring is carried out prior to the onset of egg production at 140-154 days (20-22 weeks) of age, especially for *Mycoplasmas* and *Salmonellae* in parent flocks. Usually 10% or a minimum of 100 samples are tested at this critical time. The frequency of testing will vary with the individual disease and the requirements of local trading.

Certification of freedom from specific avian pathogens is required when products from a flock, either eggs or day-old chicks, are traded between countries. The specific health requirements will vary from country to country.

Monitoring the Effectiveness of Vaccination Programs

Vaccination programs provide both active protection to the birds and passive protection to the progeny by the provision of high, uniform levels of maternally derived antibody. Monitoring of vaccination programs is important and can be achieved by measuring the level of specific antibody in individual birds and by assessing the range of response in the number of birds sampled. Usually, a minimum of 20 blood samples per group are used and various quantitative serological tests have been used to quantify antibody response in vaccinated flocks. These tests include the haemagglutination inhibition (HI) test, agar gel diffusion (AGD) test or the ELISA test. The ELISA test is considered to be specific, sensitive and repeatable, and can be automated to enhance the efficiency of serological testing in a laboratory.

Serological evaluation should be scheduled around the vaccination program so a local database is developed. If changes occur in the vaccination program, the monitoring program might also need to be changed accordingly. Each operation must develop its own baseline to facilitate interpretation of results.

Routine testing after killed vaccination (around point of lay) can allow the maternal antibody to be predicted for the total period of lay. Cross-reactions in *mycoplasma* serology are commonly seen in birds for a 2-week period after the use of killed vaccines, so sampling around this time should be avoided.

Documentation and Records

Records should be maintained for auditing and traceability. They should be clear, legible, and detailed enough to allow investigation into possible causes of poor quality, poor performance, morbidity and mortality. Records may also be used as a checklist by staff to ensure tasks are carried out.

KEY POINTS

The effectiveness of the health and biosecurity programs in place must be routinely monitored. Clear and detailed records must be in place.

Appropriate corrective action must be taken if health monitoring procedures are found to be inadequate.

OTHER USEFUL INFORMATION AVAILABLE



Veterinary How To: Take FTA Card Samples



Veterinary How To: Take Tissue Samples for Histopathology



Veterinary How To: Take Bacteriological Culture Samples



Ross Note: Histomoniasis



Ross Note: Infectious Diseases and Metabolic Syndromes Impacting Broiler Breeders

Appendix 1: Records

Record keeping, data analysis and interpretation are essential aids to effective management. Record keeping should be used in conjunction with target performance parameters. Records required to be kept are as follows:

REARING

Breed.
Source flock.
Hatch date.
Placement date.
Number of birds housed (male and female).
Floor area and stocking density.
Feeder space per bird.
Drinker space per bird.
Feed/bird – daily, weekly and cumulative.
Feed type.
Feed clean up time (per pen/per male and female).
Mortality and culls – daily, weekly and cumulative.
Body weights, average body-weight gain, CV%/uniformity and age of recording (male and female) – daily/weekly.
External and internal temperatures - minimum and maximum and operating (internal only).
Humidity.
Water consumption – daily.
Water:feed ratio.
Sexing errors.
Light program (hours and intensity).
Visitor logs – date and recommendations.

LAYING

Breed.
Source flock.
Hatch date/date of transfer.
Number of birds housed (male and female).
Floor area and stocking density.
Mating ratio.
Eggs produced – daily, weekly and cumulative per bird.
Hatching egg number – daily, weekly and cumulative.
Floor eggs – daily, weekly and cumulative.
Feed – daily and cumulative. Feed clean-up time.
Body weights, CV%/uniformity and average body-weight gain (male and female) – daily/weekly.
Average egg weight – daily and weekly.
Egg Mass – daily and weekly.
Mortality and culls – daily, weekly and cumulative.
Hatchability.
Fertility.
External and internal temperatures – minimum and maximum and operating (internal only) humidity.
Water consumption – daily.
Water:feed ratio.
Light program (hours and intensity).
Visitor logs – date and recommendations.

TREATMENTS AND SIGNIFICANT EVENTS

Lighting program.

Feed deliveries.

Water treatment – type, dosage and deliveries.

Vaccination – date, dosage, batch number and storage temperature monitoring.

Medications – date, dosage, storage temperature monitoring and veterinary prescription.

Vaccine storage temperature monitoring.

Disease – type, date and number of birds affected.

Veterinary consultations – date and recommendations.

Cleaning and disinfection – materials and methods.

Bacterial counts after cleaning out (TVC).

Incidents – equipment malfunction etc.

Monitoring programs: Biosecurity/Equipment.

TARGET PARAMETERS

Weekly body weight and average body-weight gain – male and female.

Egg production – number and weight.

Hatching egg production.

Hatchability and fertility.

Weekly egg weight and egg mass.

RECORDING SYSTEM

All essential records should be recorded in an appropriate recording system, which allows easy data recording, analysis and interpretation. Comprehensive data recording systems are freely available from Aviagen.

Appendix 2: Useful Management Information

Stocking Density Birds/m ² (ft ² /bird)		
	Rearing 0-140 Days (0-20 Weeks)	Production 140-448 Days (20-64 Weeks)
Male	3-4 (2.7-3.6)	3.5-5.5 (2.0-3.1)
Female	4-8 (1.3-2.7)	

Feeder Space Per Bird		
Males Age	Track cm (in)	Pan cm (in)
0-35 days (0-5 weeks)	5 (2)	5 (2)
36-70 days (5-10 weeks)	10 (4)	9 (3.5)
71-140 days (10-20 weeks)	15 (6)	11 (4)
141-depletion (20 weeks–depletion)	20 (8)	13 (5)
Females Age	Track cm (in)	Pan cm (in)
0-35 days (0-5 weeks)	5 (2)	5 (2)
36-70 days (5-10 weeks)	10 (4)	8 (3)
71-depletion (10 weeks-depletion)	15 (6)	10 (4)

Drinker Space		
	Rearing Period (0-15 Weeks)	Production Period (16 Weeks to Depletion)
Automatic circular or trough drinkers	1.5 cm (0.6 in) / bird	2.5 cm (1.0 in) / bird
Nipples	1 / 8-12 birds	1 / 6-10 birds
Cups	1 / 20-30 birds	1 / 15-20 birds

A Guide To Typical Mating Ratios		
Age		Number of Males/100 Females (22 Weeks to Depletion)
Days	Weeks	
154-168	22-24	9.50 - 10.00
198-210	24-30	8.50 - 9.50
210-245	30-35	8.00 - 8.50
245-280	35-40	7.50 - 8.00
280-350	40-50	7.00 - 7.50
350-depletion	50-depletion	6.50 - 7.00

Appendix 3: Conversion Tables

Length

1 meter (m)	= 3.281 feet (ft)
1 foot (ft)	= 0.305 meter (m)
1 centimeter (cm)	= 0.394 inch (in)
1 inch (in)	= 2.54 centimeters (cm)

Area

1 square meter (m ²)	= 10.76 square feet (ft ²)
1 square foot (ft ²)	= 0.093 square meter (m ²)

Volume

1 liter (L)	= 0.22 gallon (gal) or 0.264 US gallons (gal US)
1 imperial gallon (gal)	= 4.54 liters (L)
1 US gallon (gal US)	= 3.79 liters (L)
1 imperial gallon (gal)	= 1.2 US gallons (gal US)
1 cubic meter (m ³)	= 35.31 cubic feet (ft ³)
1 cubic foot (ft ³)	= 0.028 cubic meter (m ³)

Weight

1 kilogram (kg)	= 2.205 pounds (lb)
1 pound (lb)	= 0.454 kilogram (kg)
1 gram (g)	= 0.035 ounce (oz)
1 ounce (oz)	= 28.35 grams (g)
1 cubic meter (m ³)	= 35.31 cubic feet (ft ³)
1 cubic foot (ft ³)	= 0.028 cubic meter (m ³)

Temperature Conversion Chart

°C	°F
0	32.0
2	35.6
4	39.2
6	42.8
8	46.4
10	50.0
12	53.6
14	57.2
16	60.8
18	64.4
20	68.0
22	71.6
24	75.2
26	78.8
28	82.4
30	86.0
32	89.6
34	93.2
36	96.8
38	100.4
40	104.0

Energy

1 calorie (cal)	= 4.184 Joules (J)
1 Joule (J)	= 0.239 calories (cal)
1 kilocalorie per kilogram (kcal/kg)	= 4.184 Megajoules per kilogram (MJ/kg)
1 Megajoule per kilogram (MJ/kg)	= 108 calories per pound (cal/lb)
1 Joule (J)	= 0.735 foot-pound (ft-lb)
1 foot-pound (ft-lb)	= 1.36 Joules (J)
1 Joule (J)	= 0.00095 British Thermal Unit (BTU)
1 British Thermal Unit (BTU)	= 1055 Joules (J)
1 kilowatt hour (kW-h)	= 3412.1 British Thermal Unit (BTU)
1 British Thermal Unit (BTU)	= 0.00029 kilowatt hour (kW-h)

Pressure

1 pound per square inch (psi)	= 6895 Newtons per square meter (N/m ²) or Pascals (Pa)
1 pound per square inch (psi)	= 0.06895 bar
1 bar	= 14.504 pounds per square inch (psi)
1 bar	= 104 Newtons per square meter (N/m ²) or Pascals (Pa) = 100 kilopascals (kPa)
1 Newton per square meter (N/m ²) or Pascal (Pa)	= 0.000145 pound per square inch (lb/in ²)

Stocking Density

1 square foot per bird (ft ² /bird)	= 10.76 birds per square meter (bird/m ²)
10 birds per square meter (bird/m ²)	= 1.08 square feet per bird (ft ² /bird)
1 kilogram per square meter (kg/m ²)	= 0.205 pound per square foot (lb/ft ²)
1 pound per square foot (lb/ft ²)	= 4.88 kilograms per square meter (kg/m ²)

Temperature

Temperature (°C)	= (Temperature °F - 32) ÷ 1.8
Temperature (°F)	= 32 + (1.8 x Temperature °C)

Operating Temperature

Operating temperature is defined as the minimum house temperature plus 2/3 of the difference between minimum and maximum house temperatures. It is important where there are significant diurnal temperature fluctuations.

e.g., Minimum house temperature = 16°C (61°F) Maximum house temperature = 28°C (82°F)

$$\text{Operating temperature} = (28-16) \times 2/3 + 16 = 24^{\circ}\text{C}$$

$$(82-61) \times 2/3 + 61 = 75^{\circ}\text{F}$$

Ventilation

1 cubic foot per minute (ft ³ /min)	= 1.699 cubic meters per hour (m ³ /hr)
1 cubic meter per hour (m ³ /hr)	= 0.589 cubic feet per minute (ft ³ /min)

Insulation

U value describes how well a building material conducts heat and is measured in Watts per square kilometer per degree centigrade (W/km²/°C).

R value rates the insulative properties of building materials; the higher the R value, the better the insulation. It is measured in km²/W (or ft²/°F/BTU).

Insulation

1 square-foot-degree Fahrenheit-hour/ British thermal unit (ft ² ·°F·hr/BTU)	= 0.176 square kilometers per Watt (km ² /W)
1 square kilometers per Watt (km ² /W)	= 5.674 square feet per degree Fahrenheit-hour/British thermal unit (ft ² ·°F·hr/BTU)

Light

1 foot candle	= 10.76 lux
1 lux	= 0.093 fc

Appendix 4: Grading Calculations

Example of Manual Calculations for Grading

If electronic scales are not available, a manual weighing will need to be completed. From each pen/population, a random sample of birds should be caught and weighed. All birds caught in the catching pen need to be weighed to avoid selective weighing, but as a minimum, the weights of 2% of the pen/population or 50 birds, whichever is greater, need to be recorded. In this example, a total of 200 birds have been weighed.

All sample weights should be recorded on a body weight recording chart such as that given below.

Example of manual body-weight recording chart for 3-way grade.

WEIGHT		NUMBER OF BIRDS																													
LBS	G	1	2	3	4	5	6	7	8	9	10	11	12	13	14	15	16	17	18	19	20	21	22	23	24	25	26	27	28	29	30
0.00	00																														
0.04	20																														
0.09	40																														
0.13	60																														
0.18	80																														
0.22	100																														
0.26	120																														
0.31	140																														
0.35	160																														
0.40	180																														
0.44	200																														
0.49	220																														
0.53	240																														
0.57	260																														
0.62	280																														
0.66	300																														
0.71	320	x	x	x																											
0.75	340	x	x	x	x	x	x	x																							
0.79	360	x	x	x	x	x	x	x	x	x	x																				
0.84	380	x	x	x	x	x	x	x	x	x	x	x	x	x	x																
0.88	400	x	x	x	x	x	x	x	x	x	x	x	x	x	x	x															
0.93	420	x	x	x	x	x	x	x	x	x	x	x	x	x	x	x	x	x	x												
0.97	440	x	x	x	x	x	x	x	x	x	x	x	x	x	x	x	x	x	x	x	x	x	x	x	x	x	x	x	x	x	
1.01	460	x	x	x	x	x	x	x	x	x	x	x	x	x	x	x	x	x	x	x	x	x	x	x	x	x	x	x	x	x	
1.06	480	x	x	x	x	x	x	x	x	x	x	x	x	x	x	x	x	x	x	x	x	x	x	x	x	x	x	x	x	x	
1.10	500	x	x	x	x	x	x	x	x	x	x	x	x	x	x	x	x	x	x	x	x	x	x	x	x	x	x	x	x	x	
1.15	520	x	x	x	x	x	x	x	x	x	x	x	x	x	x	x	x	x	x	x	x	x	x	x	x	x	x	x	x	x	
1.19	540	x	x	x	x	x	x	x	x	x	x	x	x	x	x	x	x	x	x	x	x	x	x	x	x	x	x	x	x	x	
1.23	560	x	x	x	x	x																									
1.28	580																														
1.32	600																														
1.37	620																														
1.41	640																														
1.46	660																														
1.50	680																														
1.54	700																														
1.59	720																														
1.63	740																														
1.68	760																														
1.72	780																														
1.76	800																														
1.81	820																														
1.85	840																														
1.90	860																														
1.94	880																														

Flock Details	kg	lb
Age	28 days	28 days
Total Birds Weighed	200	200
Target Weight	0.450	0.99
Average Weight	0.458	1.01
Body Weight Range	0.249	0.55

Manual 3-way Grade Using CV% for Adjustable Penning

From the sample body weights in the previous chart (Example of manual body weight recording chart for 3-way grade), CV% for the total population can be calculated as:

$$CV\% = (\text{Standard deviation} \div \text{Average body weight}) \times 100$$

$$CV\% = (0.056 \text{ kg} \div 0.459 \text{ kg}) \times 100 = 12.3$$

$$= (0.124 \text{ lb} \div 1.012 \text{ lb}) \times 100 = 12.3$$

*standard deviation can be calculated in Excel or using a scientific calculator.

Manual calculation formula:

where:

x_i = Value of the i th point in the data set

\bar{x} = The mean value of the data set

n = The number of data points in the data set

$$\text{Standard deviation} = \sqrt{\frac{1}{(n-1)} \sum_{i=1}^n (x_i - \bar{x})^2}$$

Grading cut-offs when using CV% to grade.

Flock CV%	Percentage in Each Population After Grading			
	2- or 3-way grade	Light (%)	Average (%)	Heavy (%)
8-10	2-way grade	20	≈ 80 (78-82)	0
10-12	3-way grade	22-25	≈ 70 (66-73)	5-9
>12	3-way grade	28-30	≈ 58 (55-60)	12-15

The CV% is 12.3, so a 3-way grade is required. Using the information in the above table (grading cut-offs when using CV% to grade), the approximate percentage of birds required in each of the three populations is 28% light birds, 57% normal birds and 15% heavy birds.

Cut-off points and number of birds in each group.

	% of Birds	Number of Birds = (% birds ÷ 100) x total birds weighed
Light Birds	28	56
Average Birds	57	114
Heavy Birds	15	30

The **light**-graded population will be approximately 28% of the entire flock. Of the 200 birds weighed, the lightest 28% (or 56 birds) are in the weight range of 0.320 to 0.419 kg (0.71 to 0.92 lb). A **light** bird will therefore be a bird weighing **less than or equal to 0.419 kg (0.92 lb)**.

Using the same process the cut-off weights for the average and heavy populations can also be determined. The **average**-graded population will therefore be in the weight range of **0.420 to 0.519 kg (0.93 to 1.14 lb)**. The **heavy**-graded population will be any bird that is **0.520 kg (1.14 lb) or heavier**.

If a 2-way grade is required (i.e., CV% is below 10), the cut-off points provided in the table *Grading cut-off points when using CV% to grade* and the information from the manual body weight recording chart can be used to establish the cut-off weights for a 2-way grade in the same way as was done in the example for a 3-way grade given above.

Manual 3-way Grade Using Uniformity for Adjustable Penning

Using the sample body weight information in the manual body weight recording chart given on page 165 and the grading cut-offs given in the table below, the cut-off weights for the graded populations can be determined as follows:

Grading cut-offs when using uniformity to grade.	
Uniformity	2- or 3-way Grade
68% - 79%	2-way grade
68% or lower	3-way grade

Ideal body weight range assumed to be +/-10% of average sample weight.

$$10\% \text{ of average sample weight} = 0.1 \times 0.459 \text{ kg (0.101 lb)} = 0.046 \text{ kg (0.101 lb)}$$

Therefore,

$$+10\% \text{ of average weight} = 0.459 \text{ kg} + 0.046 \text{ kg (1.01 lb} + 0.101 \text{ lb)} = 0.505 \text{ kg (1.11 lb)}$$

$$-10\% \text{ of average weight} = 0.459 \text{ kg} - 0.046 \text{ kg (1.01 lb} - 0.101 \text{ lb)} = 0.413 \text{ kg (0.91 lb)}$$

114 birds out of 200 weighed are within the weight range that is +/- 10% of the average body weight (0.413-0.505 kg [0.91-1.11 lb]). Uniformity is therefore 57%.

As uniformity is less than 68%, a 3-way grade is required (see table above, *Grading cut-offs when using uniformity to grade*).

Light birds will be those that weigh 0.413 kg (0.91 lb) or less (-10% of the average sample weight).

Average birds will be those that weigh 0.414-0.504 kg (0.91-1.11 lb).

Heavy birds will be those that weigh 0.505 kg (1.11 lb) **or heavier** (+10% of the average sample weight).

If a 2-way grade is required (i.e. flock uniformity is 68% or greater), the information from the sample weighing can be used to establish cut-off weights for the two graded populations in the same way as was done in the example for a 3-way grade given above.

Examples of Grading When Fixed Penning is Available

Example of How to Grade Using CV% When Fixed Penning is Available.

CURRENT DATA METRIC
 TOTAL WEIGHED: 200
 AVERAGE WEIGHT: 0.459
 DEVIATION: 0.056
 C.V. (%) **12.2**

Band limits	Total
0.320 to 0.339	3
0.340 to 0.359	7
0.360 to 0.379	11
0.380 to 0.399	15
0.400 to 0.419	14
0.420 to 0.439	20
0.440 to 0.459	30
0.460 to 0.479	27
0.480 to 0.499	23
0.500 to 0.519	20
0.520 to 0.539	16
0.540 to 0.559	9
0.560 to 0.579	5

CURRENT DATA IMPERIAL
 TOTAL WEIGHED: 200
 AVERAGE WEIGHT: 1.01
 DEVIATION: 0.123
 C.V. (%) **12.2**

Band limits	Total
0.705 to 0.747	3
0.750 to 0.791	7
0.794 to 0.836	11
0.838 to 0.880	15
0.882 to 0.924	14
0.926 to 0.968	20
0.970 to 1.012	30
1.014 to 1.056	27
1.058 to 1.100	23
1.102 to 1.144	20
1.146 to 1.188	16
1.190 to 1.232	9
1.235 to 1.276	5

Flock details	kg	lb
Age	28 days	28 days
Target weight	0.450	0.99
Average weight	0.459	1.01
Total birds weighed	200	200

Based on this flock sampling data, a 3-way grade is required as detailed below; i.e., flock CV% is above 12 (see **Table 11**).

In this example, there are 4 pens each of the same size. 25% of the population will need to be housed in each pen, so the percentage of birds in each population will be 25% light, 50% average and 25% heavy.

Cut off points and number of birds in each group:

	% of Birds	Number of Birds*
Light Birds	25	50
Average Birds	50	100
Heavy Birds	25	50

*Number of birds = (% birds ÷ 100) x total birds weighed

The **light**-graded population will be approximately 24% of the entire flock. Of the 200 birds weighed, the lightest 28% (or 56 birds) are in the weight range of 0.320 to 0.419 kg (0.71 to 0.92 lb). A **light** bird will be a bird weighing **less than or equal to 0.419 kg (0.92 lb)**.

Using the same process, the cut-off weights for the average and heavy populations can also be determined.

The **average** population will be in the weight range of **0.420 to 0.519 kg (0.93 to 1.14 lb)**.

The **heavy**-graded population will be any birds that is **0.520 kg (1.14 lb) or heavier**.

Once movement of birds into each grading pen has been completed according to recommended calculated numbers/percentages and cut-off points, an adjustment to bird numbers per pen can be made (if needed) to achieve the correct stocking densities according to actual pen sizes.

If a 2-way grade is required (i.e., flock CV% is lower than 10), the percentage of birds in each population would be 25% light and 75% average, and cut-offs weights would be determined on that basis in the same way as was done for the 3-way grade example given above.

Example of How to Grade Using Uniformity When Fixed Penning is Available.

CURRENT DATA METRIC	
TOTAL WEIGHED:	200
AVERAGE WEIGHT:	0.459
DEVIATION:	0.056
C.V. (%)	12.2

Band limits	Total
0.320 to 0.339	3
0.340 to 0.359	7
0.360 to 0.379	11
0.380 to 0.399	15
0.400 to 0.419	14
0.420 to 0.439	20
0.440 to 0.459	30
0.460 to 0.479	27
0.480 to 0.499	23
0.500 to 0.519	20
0.520 to 0.539	16
0.540 to 0.559	9
0.560 to 0.579	5

CURRENT DATA IMPERIAL	
TOTAL WEIGHED:	200
AVERAGE WEIGHT:	1.01
DEVIATION:	0.123
C.V. (%)	12.2

Band limits	Total
0.705 to 0.747	3
0.750 to 0.791	7
0.794 to 0.836	11
0.838 to 0.880	15
0.882 to 0.924	14
0.926 to 0.968	20
0.970 to 1.012	30
1.014 to 1.056	27
1.058 to 1.100	23
1.102 to 1.144	20
1.146 to 1.188	16
1.190 to 1.232	9
1.235 to 1.276	5

Flock details	kg	lb
Age	28 days	28 days
Target weight	0.450	0.99
Average weight	0.459	1.01
Total birds weighed	200	200

Ideal body weight range assumed to be +/-10% of average sample weight.

$$10\% \text{ of average sample weight} = 0.1 \times 0.459 \text{ kg (0.98 lb)} = 0.046 \text{ kg (0.101 lb)}$$

Therefore,

$$+10\% \text{ of average weight} = 0.459 \text{ kg} + 0.046 \text{ kg (1.01 lb} + 0.101 \text{ lb)} = 0.505 \text{ kg (1.11 lb)}$$

$$-10\% \text{ of average weight} = 0.459 \text{ kg} - 0.046 \text{ kg (1.01 lb} - 0.101 \text{ lb)} = 0.413 \text{ kg (0.91 lb)}$$

114 birds out of 200 weighed are within the weight range that is +/- 10% of the average body weight (0.413-0.505 kg [0.91-1.11 lb]), highlighted blue in the electronic print-out. Uniformity is therefore 57%.

As uniformity is less than 68%, a 3-way grade is required (see Table 12).

In this example there are 4 pens each of the same size. 25% of the population will need to be housed in each pen, so the percentage of birds in each population will be 25% light, 50% average and 25% heavy.

	% of Birds	Number of Birds*
Light Birds	25	50
Average Birds	50	100
Heavy Birds	25	50

*Number of birds = (% birds ÷ 100) x total birds weighed

The **light**-graded population will be 25% of the entire flock. Of the 200 birds weighed, the lightest 25% (or 50 birds) are in the weight range of 0.320 to 0.419 kg (0.71 to 0.92 lb). A **light** bird will be a bird weighing **less than or equal to 0.419 kg (0.92 lb)**.

Using the calculation above the cut-off weights for the average and heavy populations can also be determined.

The **average**-graded population will be in the weight range of **0.420 to 0.499 kg (0.92 to 1.10 lb)**.

The **heavy**-graded population will be any bird that is **0.500 kg (1.10 lb) or heavier**.

Once movement of birds into each grading pen has been completed according to recommended calculated numbers/percentages and cut-off points, an adjustment to bird numbers per pen can be made (if needed) to achieve the correct stocking densities according to actual pen sizes.

If a 2-way grade is required (i.e., flock uniformity is greater than 68%), the percentage of birds in each population would be 25% light and 75% average, and cut-offs weights would be determined on that basis in the same way as was done for the 3-way grade example given above.

Appendix 5: Calculations for Ventilation Rates

Minimum Ventilation Calculation for Fan Timer Settings

Employ the following steps to determine the interval fan timer settings for minimum ventilation.

Note: These calculations do not guarantee to provide acceptable air quality in the house. The example below is a minimum ventilation calculation based on bird fresh air requirements. It is often necessary to increase this rate in order to control RH levels in the house.

Obtain the appropriate minimum ventilation rate as recommended in **Table 25** (page 113). Check with the company of manufacture for more specific information. The rates given in **Table 25** are for temperatures between -1 and 16°C (30 and 61°F). For lower temperatures a slightly lower rate may be required, and for higher temperatures, a slightly higher rate.

Example (Metric)

Units:

Cubic meters per hour = m³/hr

Assumptions

Bird age = 15 weeks

Bird weight = 1.6 kg

Number of birds = 10,000

Minimum ventilation fan = 1 (91 cm in diameter)

Minimum ventilation rate = 1.23 m³/hr/bird

Minimum ventilation fan capacity = 15,300 m³/hr

Using a 5-minute (300 seconds) cycle timer

Step 1: Calculate the total minimum ventilation rate required for the house (m³/hr).

Minimum ventilation requirement = number of birds in the house x ventilation rate per bird

= 10,000 birds x 1.23 m³/hr/bird

= 12,300 m³/hr

Step 2: Calculate the actual ON time of the fans:

ON time = (ventilation required ÷ minimum ventilation fan capacity) x (cycle time)

ON time = (12,300 m³/hr ÷ 15,300 m³/hr) x (300 seconds) = 241 seconds

So, ON time = 241 seconds, and OFF time = 300 seconds – 241 seconds = 59 seconds

NOTE: Cycle time = ON time + OFF time.

Example (Imperial)

Units:

lb = pounds

cfm = cubic feet per minute

Assumptions:

Bird age = 15 weeks

Bird weight = 3.53 lb

Number of birds = 10,000

Minimum ventilation fan = 1 (36 inches in diameter)

Minimum ventilation rate = 0.72 cfm/bird

Fan capacity = 9,000 cfm

Using a 5-minute (300 second) cycle timer

Step 1: Calculate the total minimum ventilation rate required for the house (cfm):

Minimum ventilation requirement = number of birds in the house x ventilation rate per bird

$$= 10\,000 \text{ birds} \times 0.72 \text{ cfm/bird}$$

$$= 7,200 \text{ cfm}$$

Step 2: Calculate the actual ON time of the fans:

$$\text{ON time} = (\text{ventilation required} \div \text{minimum ventilation fan capacity}) \times (\text{cycle time})$$

$$\text{ON time} = (7,200 \text{ cfm} \div 9,000 \text{ cfm}) \times (300 \text{ seconds}) = 240 \text{ seconds}$$

So, ON time = 240 seconds, and OFF time = 300 seconds - 240 seconds = 60 seconds

NOTE:

- Cycle time = ON time + OFF time.
- Regardless of any calculation, the minimum ON time should be long enough for the incoming air to reach the peak of the house and start to move down towards the floor.
- This minimum ON time can be determined by performing a smoke test in the house.

Calculation of Number of Fans Required for Tunnel Ventilation

IMPORTANT NOTES: The following is a simplified example calculation of a production house. Although the calculations themselves are uncomplicated, the assumption made of the fan operating pressure is dependent on a number of factors. These factors include the house construction, partition fences, design air speed, nest layout, use of light traps, type of light trap used and type of cooling pads. If incorrect assumptions are made about the operating pressure of the fans, it can have a considerable effect on the number of fans used, and ultimately, the actual air speed in the house. If designing an all-in-all-out rearing/production house, one needs to take into account the performance of the fans with and without light traps. This can make a significant difference to the design.

Example Calculation (Metric)

Calculation of Number of Fans Required for Tunnel Ventilation

Note that in the example below, metric values have not been converted exactly to imperial units. Conversion values were rounded to simplify the example, and as such the number of fans and cooling pad area do not match exactly.

Assumptions:

Bird age = 20 weeks

Number of birds = 10,000

House width (W) = 12 m

Side wall height (H) = 2.4 m

Roof height (R) = 1.5 m

House has an open ceiling structure (not a flat ceiling)

Design air speed = 3 m/s (production)

Fan operating pressure = 40 Pa

Fan capacity at 40Pa = 35,000 m³/hr

Cooling pad flute angle = 45 x 15

Cooling pad thickness = 150 mm

Design air speed through 45 x 15 cooling pads = 1.78 m/s

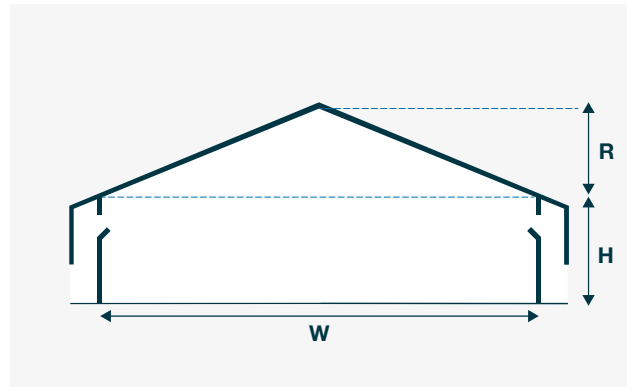

Step 1: Calculate the required fan capacity

Cross-section area:

$$= \text{Cross-section area (m}^2\text{)} = (0.5 \times W \times R) + (W \times H)$$

$$= (0.5 \times 12 \text{ m} \times 1.5 \text{ m}) + (12 \text{ m} \times 2.4 \text{ m}) = 37.8 \text{ m}^2$$

Required fan capacity (m³/hr):

$$= \text{design air speed (m/s)} \times \text{cross section area (m}^2\text{)} \times 3600$$

$$= 3 \text{ m/s} \times 37.8 \text{ m}^2 \times 3,600 = 408,240 \text{ m}^3/\text{hr}$$

Note: Cross-section area is the area of the house through which the air flows; 3600 converts seconds to hours.

Step 2: Calculate the number of fans required

Number of fans:

$$= \text{required fan capacity (m}^3/\text{hr)} \div \text{capacity (m}^3/\text{hr)} \text{ per fan at assumed pressure}$$

$$= 408,240 \text{ m}^3/\text{hr} \div 35,000 \text{ m}^3/\text{hr} = 11.7 \text{ fans}$$

Suggestion – use 12 fans

Total operating fan capacity:

$$= 12 \times 35,000 \text{ m}^3/\text{hr} = 420,000 \text{ m}^3/\text{hr}$$

Step 3: Calculate the cooling pad area

Cooling pad area (m²):

$$= \text{total operating fan capacity (m}^3/\text{hr)} \div \text{design air speed through cooling pads (m/s)} \div 3,600$$

$$= 420,000 \text{ m}^3/\text{hr} \div 1.78 \text{ m/s} \div 3,600 = 65.5 \text{ m}^2$$

Example Calculation (Imperial)

Assumptions:

Bird age = 20 weeks

Number of birds = 10,000

House width (W) = 39.3 ft

Side wall height (H) = 7.9 ft

Roof height (R) = 4.9 ft

House has an open ceiling structure (not a flat ceiling)

Design air speed = 600 fpm (production)

Fan operating pressure = 0.16 inch WC (inches water column)

Fan capacity at 0.16 inch WC = 20,584 cfm

Cooling pad flute angle = 45 x 15

Cooling pad thickness = 6 inch

Design air speed through 45 x 15 cooling pads = 350 fpm

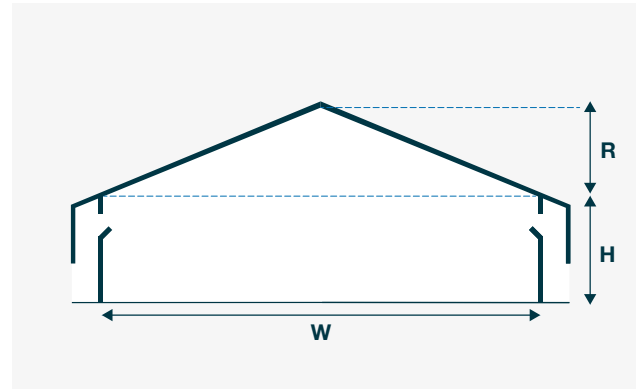

Step 1: Calculate the required fan capacity

Cross-section area:

$$= \text{Cross-Section area (ft}^2\text{)} = (0.5 \times W \times R) + (W \times H)$$

$$= (0.5 \times 39.3 \text{ ft} \times 4.9 \text{ ft}) + (39.3 \text{ ft} \times 7.9 \text{ ft}) = 406.8 \text{ ft}^2$$

Required fan capacity (cfm):

$$= \text{design air speed (fpm)} \times \text{cross section area (ft}^2\text{)}$$

$$= 600 \text{ fpm} \times 406.8 \text{ ft}^2 = 244,053 \text{ cfm}$$

Note: Cross-section area is the area of the house through which the air flows.

Step 2: Calculate the number of fans required

Number of fans:

$$= \text{required fan capacity (cfm)} \div \text{capacity (cfm) per fan at assumed pressure}$$

$$= 244,053 \text{ cfm} \div 20,584 \text{ cfm} = 11.9 \text{ fans}$$

Suggestion – use 12 fans

$$\text{Total operating fan capacity} = 12 \times 20,584 \text{ cfm} = 247,008 \text{ cfm}$$

Step 3: Calculate the cooling pad area

Cooling pad area (ft²):

$$= \text{total operating fan capacity (cfm)} \div \text{design air speed through cooling pads (fpm)}$$

$$= 247,008 \text{ cfm} \div 350 \text{ fpm} = 705 \text{ ft}^2$$

Activity.....	7, 25, 60, 65, 66, 73, 82, 83, 87-90, 114, 115, 123, 144, 154, 155	Body-weight profile.....	16, 44, 59, 82, 91, 125, 129
Adjustable penning.....	39-42, 47, 48, 166, 167	Body-weight recording	78, 165
Air flow	12, 48, 103, 106-107, 110-112, 114-117, 119, 122	Body-weight targets	8, 44-45, 135, 138
Air inlet	109-111, 114	Breast shape	81, 83, 85
Air leakage.....	103, 108, 109	Brooding	7, 17, 20-25, 27-29, 33-35, 82, 90, 104, 106, 109, 112, 123, 124, 127
Air quality.....	12, 27-29, 109, 113-114, 170	Bulk weighing	7, 63, 77
Air speed.....	12, 27, 110-111, 113, 116-117, 121-122, 171-173	Calcium.....	59, 120, 136-138, 141, 147, 148, 151
Air tightness	103, 105	Chick placement.....	7, 17, 29, 39
Airborne disease.....	102	Chick transport.....	17, 18, 29
Alertness	10, 13, 82-83, 89-90	Chloride.....	137, 151
All in/all out.....	145, 153	Chlorination	35, 150, 154
Amino Acids	37, 136, 138-139, 141	Coccidiosis.....	18, 24, 25, 39, 153-154
Antibiotics.....	155	Coefficient of variation	8, 39, 78
Antibody	153, 156-157	Coliforms.....	140, 150-151
Anti-nutritional factors.....	140	Comb.....	53-56, 65-66, 82, 87
Automated feeding	32	Condensation.....	93, 95-96, 98
Automatic weigh scale.....	76	Contaminated feed.....	155
Bacterial counts.....	35, 141, 150, 160	Controlled-environment housing	103, 107, 123-124
Bacterial contamination	19, 21, 35, 61, 93-96, 140, 147, 150, 155	Conversion tables.....	130, 162
Behavior	7, 11-13, 17, 21, 24-29, 31, 36, 53, 54, 56, 58, 61, 65, 66, 105, 113-115, 117-118, 122, 138, 139	Critical age objectives	7-9
Biofilms	147	Crop fill.....	7, 10, 16, 28-29, 35, 52-53
Biosecurity.....	7, 19, 21, 35, 36, 52, 101-102, 104, 105, 142-158, 160	Crumb.....	12, 21, 28, 32, 138
Bird condition	9, 72, 81, 83, 85, 91, 92	CT	91
Bird distribution	10, 12, 27, 31, 33	Curtains.....	106-107, 126, 146-148
Blackout	103, 107, 123, 126-127	CV%.....	8, 16, 33, 39-41, 43-44, 52, 59, 75-80, 90, 124-125, 127, 159, 166-168
Body condition	13, 58-59, 62, 65-67, 73, 81-86, 89, 91, 136	Daylength.....	7, 24, 46, 52, 101, 103, 123-129
Body weight	8-9, 16, 33, 39-40, 43-46, 48, 50-51, 56-60, 62-63, 65-43, 75, 77-83, 86, 89, 92, 103, 114, 123, 123, 125, 136, 138, 141, 160, 165-167, 169	Dead bird disposal.....	152
		Direction plates.....	111
		Dirty eggs.....	61, 95, 98
		Disease	17, 20, 27, 38, 59, 80, 90, 102, 106, 137, 140, 143-146, 149, 152-156, 160
		Disinfection.....	19, 24, 35, 93, 95-98, 103, 143, 145-149, 160

Disposal of dead birds	152	Feed allocation	8, 12, 24, 43, 47, 62, 63, 68, 73, 73, 83, 91
Downtime	145, 149, 154	Feed bin	140
Drainage	102	Feed clean-up time	9, 59, 62-63, 65, 68, 72, 136, 152, 159
Drinker height	73	Feed formulation	148
Drinker space	21, 29, 30, 33, 36, 49, 50, 59, 62, 159, 161	Feed hygiene	140, 155
Drinkers	7, 12, 21-24, 29-30, 33-35, 52, 82, 114, 146, 161	Feed level	62, 71
Dust	10, 20, 63, 106, 122, 146-147, 156	Feed manufacture	140
Egg collection	59, 61, 95-97	Feed quality	12, 63, 68, 73
Egg cooling	98	Feed samples	141
Egg disinfection	96, 98	Feed specifications	138
Egg selection and packing	87	Feed systems	19, 147
Egg production	9, 11, 16, 49, 51, 56, 59, 62-63, 65-69, 72, 81, 90-92, 103, 117, 123-125, 127, 129, 139, 141, 155, 156, 160	Feed texture	63, 68
Egg storage	93, 98, 143	Feeder height	32, 47-48, 57-58, 83
Egg temperature	97	Feeder space	8, 30, 31, 49, 52, 60, 82, 90, 159, 161
Egg transport	95, 97-98	Feeding behavior	31, 53-54, 56, 58, 65, 138
Egg weight	9, 16, 50, 62-65, 67-72, 90, 91, 123, 159, 160	Feeding equipment	56-57, 102, 138, 148
Electronic scales	40, 76, 79, 165	Feeding management	31, 48, 90, 135, 138, 140
ELISA	156-157	Feedstuffs	140
Energy	37, 46, 50, 52, 62-63, 68, 69, 72, 92, 117, 132, 135-139, 141, 163	Feel	10, 12, 26, 81, 85, 90, 92, 114-117, 122
Environment	7, 10-13, 17, 24-26, 28, 30, 36-37, 49, 61-62, 95-96, 98, 101, 103-108, 118-119, 122-124, 126-127, 132, 148, 152, 154, 156	Feet	13, 17, 81, 82, 87, 89, 109, 162-164, 171
Evaporative cooling	25, 107, 117-119, 121-122, 147	Fertility	16, 49, 51, 56, 65-67, 72-73, 81-83, 87, 89, 92, 133, 139, 141, 155, 159, 160
Fans	11, 12, 48, 98, 103-104, 106-109, 112-119, 122, 147-149, 170-173	Filter	150
Farm design	102	Fines	33
Fat pad	91-92	First egg	9, 15, 59-62, 90
Fats	139-140	Five freedoms of animal welfare	14
Feathering	13, 55, 65-66, 68-69, 82, 88, 141	Fixed penning	41, 43, 168-169
		Fleshing	8, 13, 16, 50, 59, 62, 73, 81-86, 90-92
		Floor eggs	36, 60, 96, 98-99, 117, 125, 133, 159
		Floor feeding	20, 32, 36, 48, 140
		Floor space	24, 30, 39, 41, 49, 50
		Fogging	93, 96, 117, 120, 122, 147

Footpad.....	25, 73	Keel bone.....	84-85, 91-92
Formaldehyde.....	96, 98, 140	Laboratory analysis.....	135
Formalin.....	148	Lamp type.....	132-133
Fumigation.....	146-148	Legs and feet.....	81, 82, 87, 89
Grading.....	8, 16-18, 38-45, 47-48, 143, 165-169	Light birds.....	41-42, 166-169
Grill.....	56-57	Light leakage.....	123, 125
Grower feed.....	138	Light spectrum.....	131-132
Growth.....	8, 11, 15-16, 21, 24, 32, 35, 39, 44, 46, 62, 67-69, 73, 75-81, 90, 93-94, 98, 106, 131, 136-141, 150-151	Lighting.....	8, 12, 15-16, 24, 36, 52, 59-60, 63, 102-103, 105, 123-130, 132, 160
Handling.....	9, 14, 17, 75, 81, 90, 99, 153-154	Lighting programs.....	52, 59, 63, 123-124, 126-127, 129
Hard water.....	120, 150	Limestone.....	136-137
Hatchability.....	62, 66, 72, 92-94, 96-98, 137, 140-141, 159-160	Litter.....	7, 10, 12-13, 19-20, 23-25, 29, 32, 36-39, 48, 58, 60, 73, 83, 96, 106-107, 109-110, 114, 120, 122, 124-125, 137, 143, 145-147, 154, 156
Hatching eggs.....	63, 67, 93-100, 140	Male feeding.....	57-58, 65, 139
Head.....	27, 56, 66, 82, 87, 92, 112, 124-125, 127	Manometer.....	108
Health monitoring.....	156-157	Manual feeding.....	32
Hearing.....	10	Marek's disease.....	155
Heat treatment.....	140-141, 155	Mash.....	33, 37, 63, 68, 137, 140
Heating equipment.....	104, 106	Mating.....	9-10, 12-13, 15-16, 53-57, 60, 65-66, 73, 79, 82-83, 87-89, 93, 114, 159, 161
Heavy birds.....	41-43, 166-169	Mating ratios.....	9, 60, 66, 73, 82, 161
Helminth.....	154	Maturity.....	8, 9, 13, 15-16, 49-56, 59-60, 81-83, 92, 103, 123, 125, 127, 129, 133, 139
House cleaning.....	19, 21, 103, 150, 154	Metabolic disorders.....	137
House design.....	39, 101-105, 115, 146	Migration.....	116
Humidity.....	7, 16, 23-27, 39, 93, 95, 98, 101, 105-107, 113-114, 116-117, 119, 141, 159	Minerals.....	37, 102, 136-137
Hygiene.....	19-20, 33, 60, 95-96, 98, 140, 144, 149, 153, 155	Misting.....	120, 122
Immunological response.....	152-153	Monitoring.....	7, 10, 25, 27-29, 45, 50-51, 53, 56, 59, 62-63, 65, 68, 71-73, 75-83, 90-92, 105, 117, 138, 141, 149, 154-157, 160
Incineration.....	152	Monitoring body.....	68, 79, 83, 91
Infection.....	87, 140, 144, 154-155	Mycoplasma.....	153, 156-157
Inlets.....	11-12, 48, 103, 105-116, 120, 122-123, 147	Mycotoxin.....	141
In-season flocks.....	129	Natural-environment.....	123, 126
Insect control.....	146		
Insulation.....	103, 105, 164		

Nests.....	12, 59-61, 97	Pressure.....	11, 21, 73, 103, 105, 107-108, 110-115, 120, 122, 140, 146, 163, 171-173
Normal distribution	38	Protein.....	37, 68, 94, 136, 139, 141
Nutrient composition	135-137	Quality control	137, 141-142
Nutrient intake	63, 135-136, 138	Random sample	40, 52, 165
Nutrient recommendations	136	Raw material	140
Oils.....	140	Rear	15, 29-30, 33, 36-37, 43, 46-47, 52-53, 77, 81-82, 90-91, 103, 123-126, 135-136, 142
Open-sided housing	102-103, 106, 126, 128, 147	Rear and move.....	52-53, 126
Operating temperature	139, 164	Recirculation fans	107
Out-of-season flocks	127, 129	Records.....	11, 13, 75, 152, 154-155, 157, 159-160
Over-mating.....	60, 66	Regulations	17, 49, 101-102, 146, 153
Overweight birds	51	Relative humidity	7, 95, 107, 113-114, 116, 119
Pad cooling	118-119, 122	Removal of males	66
Pan feeder.....	31	Rendering.....	148, 152
Pathogens.....	7, 102, 140, 144, 146, 148, 150, 154, 156	Repairs and maintenance	148
Peak production	9, 49-68, 72-73, 81, 92	Respiratory disease	27, 106
Pellet	21, 32, 48, 63, 138, 140	Rodent	145
Pen size.....	43	Rotten eggs (bangers)	96
Perches.....	36, 60, 146	Salmonella.....	140-141, 149, 153, 155-156
Perimeter.....	19, 102, 144	Sample weighing	42, 75, 77, 79-80, 90, 167
Persistency.....	51, 65-67, 70, 72-73, 81-82, 92, 124, 127	Sanitize.....	144
Pest management	145	Seasonal variation	128
Phosphorus.....	136	Sediment.....	150
Photorefractory.....	123, 125	Sensors.....	27, 117
Photostimulation.....	15-16, 123-125, 128	Separate sex feeding.....	53
Physical assessment	81-81	Serological monitoring	156
Pin bones	59, 90	Sexing errors	8, 53, 55, 159
Placement	7, 17-18, 20-21, 24-25, 28-29, 36, 38-39, 77, 81-82, 123, 129, 145, 154, 159	Sexual maturity.....	8, 13, 15-16, 49-54, 59-60, 81-83, 92, 123, 125, 127, 129, 133, 139
Platform scales.....	76, 79	Shank length	81-82, 90
Post-peak management	67	Shell quality	67, 136-137, 141
Potassium	137, 151	Sight.....	10
Power availability	102	Site.....	102-103, 141, 144-146, 149, 153

Site cleaning	144, 146, 149	Underfeeding.....	65, 69
Skeleton	82	Underweight birds	8, 51
Smell	10, 12, 33, 106	Uniformity	8-9, 16-17, 24, 29, 31-33, 38-40, 42-44, 49-52, 56-59, 66, 73, 75, 77, 82, 86, 90, 97, 12-125, 127, 133, 135, 138, 140, 159, 167, 169
Sodium.....	37, 132, 137, 142, 151	UV.....	96, 98, 130-131, 133
Soiled eggs	96	Vaccination programs	143, 153, 157
Spin feeders	32, 48	Vent (cloaca).....	89
Spot brooding	22, 25, 27-28	Ventilation.....	7, 11-12, 16-17, 26-30, 36, 48-50, 73, 101-119, 122, 146-148, 154, 164, 170-172
Spray cooling	118	Ventilation calculation	170-173
Standard deviation.....	39, 78, 166	Visitors	105, 143-144
Starter feed	29, 46, 138	Vitamin potency.....	137
Stock sense	10, 13-14	Vitamins	35, 137, 141
Stocking density.....	22, 24, 30, 39-40, 43, 47-50, 59, 62, 73, 103, 105, 107, 116-117, 144, 159, 161, 163	Vocalization	10
Stockman.....	10, 11, 14	Walk-through.....	62, 81
Stockmanship	10-14, 29, 36, 81	Washed eggs	96
Sudden Death Syndrome	137	Water	7, 12-13, 16, 19-21, 23-24, 28-29, 33-37, 48, 52-53, 59, 61, 73, 93, 95-96, 98, 102, 106-108, 118-120, 122-123, 137, 142, 144, 146-147, 149-155, 159-160, 173
Synchronization	50-51, 125-126	Water quality.....	35, 120, 142, 150-151
Target parameters	160	Water:feed ratio	159
Target performance	68	Wattles	53, 55, 66
Target weight.....	8, 16, 41-43, 50-51, 65, 77-78, 80, 92, 125, 166, 168-169	Wavelength.....	130-132
Temperature	7, 10, 12, 16-17, 20-29, 36, 39, 52, 62-63, 68, 72, 93-95, 97-98, 101, 104-107, 109, 112-122, 131-132, 136, 139-142, 152, 160, 162-164	Weigh scales	43, 79
Temperature gradient.....	23	Weight profile.....	16, 44, 59, 63, 82, 91, 125, 129
Three essentials of stockmanship	14	Welfare	9-11, 14, 17, 24, 30, 35-36, 49, 53, 66, 75, 87, 101, 103, 105, 123, 130-131, 135-136, 139, 143-144, 146, 148, 150, 152, 156
Timer.....	12, 109, 112-114, 170-171	Whole-house brooding	23, 25, 28
Toast rack.....	56	Wind chill.....	116-117
Trace minerals	37, 137	Wind speed.....	116
Track feeder	31-32		
Transitional ventilation.....	108, 114-116		
Tube feeders.....	57		
Tunnel ventilation	103, 107-109, 114-119, 122, 171-172		



Aviagen®
www.aviagen.com

Every attempt has been made to ensure the accuracy and relevance of the information presented. However, Aviagen accepts no liability for the consequences of using the information for the management of chickens.

For further information on the management of Ross stock, please contact your local Ross representative.

Aviagen, the Aviagen logo, Ross and the Ross logo are registered trademarks of Aviagen in the US and other countries.
All other trademarks or brands are registered by their respective owners. © 2023 Aviagen.